



***Transducer-Class*[®] Strain Gages** **Micro-Measurements**

Strain Gages
Bondable Resistors
Installation Accessories



INTERACTIVE Data Book
VMM-DB0104-1105

Click on the VPG logo on any datasheet to go to the contents page for that section.

Click on the VPG logo on any contents page to go to the main table of contents page.



www.micro-measurements.com

The Americas

United States **Vishay Precision Group – Micro-Measurements**
P.O. Box 27777 • Raleigh, NC 27611
Ph: +1-919-365-3800 • Fax: +1-919-365-3945
E-mail: mm.us@vishaypg.com

Asia

P.R. China **Vishay Precision Group – Micro-Measurements**
A8220, Shanghai Jia Hua Business Center
No. 808 Hong Qiao Road • Shanghai 200030
Ph: +86-21-6448-6090, Ext. 6098 • Fax: +86-21-6448-6070
E-mail: mm.cn@vishaypg.com

Europe

France **Vishay Precision Group – Micro-Measurements**
16 Rue Francis Vovelle • 28000 Chartres
Ph: +33-2-37-33-31-20 • Fax: +33-2-37-33-31-29
E-mail: mm.fr@vishaypg.com

Germany **Vishay Precision Group – Micro-Measurements**
Tatschenweg 1 • 74078 Heilbronn
Ph: +49-7131-39099-0 • Fax +49-7131-39099-229
E-mail: mm.de@vishaypg.com

Spain **Vishay Precision Group – Micro-Measurements**
C/Copenhagen, N°4, 6 y 8 - Planta 1ª - Oficina 12 • Edificio Al Andalus
Polígono Európolis • 28232 Las Rozas, Madrid
Ph: +34-916-407-624 • Fax: +34-916-375-601
E-mail: mm.es@vishaypg.com

United Kingdom **Vishay Precision Group – Micro-Measurements**
Stroudley Road • Basingstoke • Hampshire RG24 8FW
Ph: +44-(0)125-646-2131 • Fax: +44-(0)125-647-1441
E-mail: mm.uk@vishaypg.com

Transducer-Class[®]

**Strain Gages, Bondable Resistors,
Installation Accessories**

**Vishay Precision Group
Micro-Measurements
P.O. Box 27777
Raleigh, NC 27611
U.S.A.
Phone: +1-919-365-3800
Fax: +1-919-365-3945
www.micro-measurements.com**

DISCLAIMER

All product specifications and data are subject to change without notice.

Vishay Precision Group, Inc., its affiliates, agents, and employees, and all persons acting on its or their behalf (collectively, "Vishay Precision Group"), disclaim any and all liability for any errors, inaccuracies or incompleteness contained herein or in any other disclosure relating to any product.

Vishay Precision Group disclaims any and all liability arising out of the use or application of any product described herein or of any information provided herein to the maximum extent permitted by law. The product specifications do not expand or otherwise modify Vishay Precision Group's terms and conditions of purchase, including but not limited to the warranty expressed therein, which apply to these products.

No license, express or implied, by estoppel or otherwise, to any intellectual property rights is granted by this document or by any conduct of Vishay Precision Group.

The products shown herein are not designed for use in medical, life-saving, or life-sustaining applications unless otherwise expressly indicated. Customers using or selling Vishay Precision Group products not expressly indicated for use in such applications do so entirely at their own risk and agree to fully indemnify Vishay Precision Group for any damages arising or resulting from such use or sale. Please contact authorized Vishay Precision Group personnel to obtain written terms and conditions regarding products designed for such applications.

Product names and markings noted herein may be trademarks of their respective owners.

TRANSDUCER-CLASS® STRAIN GAGES

General Information	4
Gage Series	6
Creep and Modulus Compensation	8
Designation System	9
Linear Patterns - Single Grid	10
Linear Patterns - Dual Grid	14
90° Patterns - Dual Grid	17
Shear Patterns - Single Grid	20
Shear Patterns - Dual Grid	22
High Resistance Patterns	25
Full Bridge Patterns	26
Diaphragm Patterns - Circular	28
Diaphragm Patterns - Linear	30
Platinum-Tungsten Alloy Strain Gages	33
Bondable Resistors for Transducers	36
Bondable Resistor Patterns	38
Resistor Adjustment Instructions	40

M-LINE ACCESSORIES FOR TRANSDUCER APPLICATIONS

Surface Cleaning Supplies	42
M-Bond 610	44
M-Bond 43-B for Transducers	45
M-Bond 450	46
Installation Tools	47
Bondable Terminals	50
Solders and Accessories	52
Wire, Cable and Accessories	54
M-Coat A	56
M-Coat B	57
M-Coat C	58
M-Coat D	59
M-Coat FBT	60
M-Coat W-1	61
3140 RTV	62
3145 RTV	63
TAK-610 Kit	64
TransCalc™ Software	65



Transducer-Class[®] Strain Gages

General Information.....	4
Gage Series	6
Creep and Modulus Compensation	8
Designation System	9
Linear Patterns - Single Grid	10
Linear Patterns - Dual Grid.....	14
90° Patterns - Dual Grid	17
Shear Patterns - Single Grid	20
Shear Patterns - Dual Grid	22
High Resistance Patterns.....	25
Full Bridge Patterns.....	26
Diaphragm Patterns - Circular ...	28
Diaphragm Patterns - Linear	30
Platinum-Tungsten Alloy Strain Gages	33
Bondable Resistors for Transducers	36
Bondable Resistor Patterns.....	38
Resistor Adjustment Instructions	40

Transducer-Class® Strain Gages

Micro-Measurements has been a trusted name in the field of Strain Gage Technology for more than 45 years. We are proud of our worldwide reputation as a premier supplier of high-quality precision strain gages and strain gage accessories, and are fully committed to maintaining our position as the leader in this field. This databook of Micro-Measurements *Transducer-Class* strain gages and related products for OEM applications is intended to provide an overview of the sensors and installation accessories and tools needed for successful transducer strain gage applications.

TRANSDUCER-CLASS®

Transducer-Class® strain gages are a select group of gage patterns designed specifically for transducer applications. The main objective is optimum gage performance at lower cost in high-volume production quantities. Exclusive features of *Transducer-Class*® gages include:

- Optimum backing thickness tolerance. This is particularly important to minimize creep variations between gage installations.
- Uniform backing trim dimensions. Matrix dimensions listed in this bulletin have a tolerance of ± 0.005 in (± 0.13 mm) on any edge (measured from grid centerlines). On many transducer designs this will allow the gage matrix to be used for gage alignment. Gage placement for bonding can be fixtured more easily for reduced assembly time.
- Multiple creep compensation choices for most gage patterns. A close inspection of the gage pattern will reveal a small letter on the gage matrix next to the grid. This letter is the creep compensation code. Different creep compensations of the same pattern can be easily identified after removing gages from the package.
- Special pattern refinement for improved gage-to-gage reproducibility. Creep variation due to operating temperature changes is reduced.

INSTALLATION ACCESSORIES

Construction of the strain gage is completed when it is bonded and wired — final manufacturing steps that our customers undertake. To help ensure successful transducers, Micro-Measurements *M-LINE* Accessories are extensively tested before being selected for strain gage use. Clear, concise instructions are provided to make these final manufacturing steps as risk-free as possible.

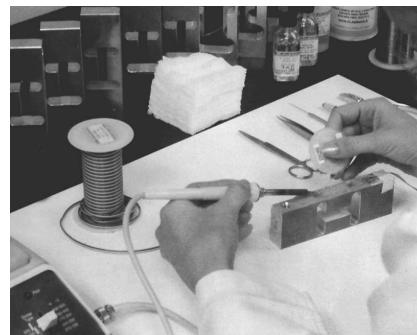

APPLICATIONS ASSISTANCE

Our Transducer Applications Department is dedicated to providing accurate, friendly and confidential answers to your strain gage application questions. With a fully equipped laboratory and all of Micro-Measurements' combined engineering, manufacturing, and applications experience available to them, our Applications Engineers are "on-call" for you.

Individualized customer training is available in our Applications Laboratory or Technical Training Center near Raleigh, North Carolina USA.



Transducer-Class[®] Strain Gages

REFERENCE LITERATURE

Technical and product literature, along with special publications like our *Strain Gage Based Transducers* booklet, are available at no charge.

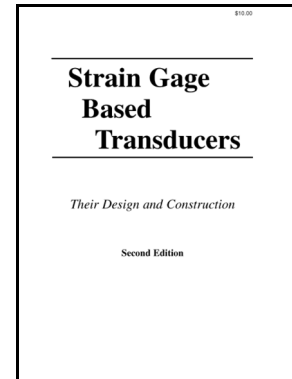

CUSTOMER SERVICE

We know that we must deliver in order for you to produce. Our Customer Service Department works daily with the individual requirements of our *Transducer-Class* customers to make sure that we supply the product you need — when you need it. Purchase conditions are tailored to your requirements, optimizing price/performance and minimizing inventory costs while ensuring the supply of reliable, high-quality strain gages and accessories.



Transducer Class® Strain Gages

N2A SERIES

N2A gages are open-faced constantan-alloy patterns constructed on a thin, laminated, polyimide-film backing. This series is capable of low and repeatable creep performance. Construction is very rugged, which will help prevent gage handling damage.

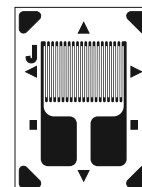

J2A SERIES

J2A gages are encapsulated constantan-alloy patterns. Both the encapsulation and backing are thin, laminated polyimide film. Gage soldering tabs are exposed for simplified lead connections. Creep performance is equal to the N2A Series, although the presence of an encapsulating layer will require a change in creep code selection to maintain the same performance.

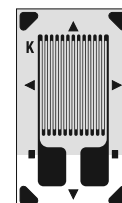

EA SERIES

EA gages are open-faced constantan-alloy patterns with a flexible cast-polyimide backing. Creep scatter is somewhat more pronounced than with all other series. Consequently, EA gages are normally available with only one creep code per pattern.

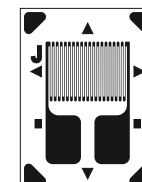

N2K SERIES

N2K gages are open-faced modified-Karma-alloy patterns constructed on a thin, laminated, polyimide-film backing. More rugged and flexible than the TK or SK Series, N2K gages are popular for transducer applications where lower cost K-alloy gages are desired. All N2K gages are supplied with copper soldering pads (DP) for ease of leadwire attachment. Most gages in the N2K Series can also be modulus compensated

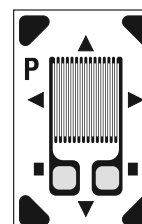

N3K SERIES

N3K gages are special, open-faced, modified-Karma-alloy patterns constructed on an ultrathin, laminated polyimide-film backing. Their small size and high resistance (5000 Ω) makes them ideally suited for 4 to 20mA process control transmitters and battery-operated systems. All N3K gages are supplied with a copper soldering pad (DP) on each gage tab.

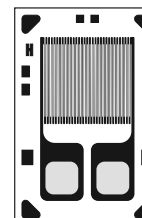

TK SERIES

TK gages are open-faced modified-Karma-alloy patterns with a thin, reinforced, laminate backing. These gages have a higher operating temperature range and greater fatigue life than N2A, J2A, EA, N2K, or N3K gages. However, they are generally more costly. Most gages in the TK Series can also be modulus compensated. All TK gages are supplied with a copper soldering pad (DP) on each gage tab.

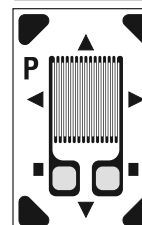

SK SERIES

SK gages are fully encapsulated, modified-Karma-alloy patterns with a preformed solder dot on each gage tab. Both backing and encapsulation are thin, reinforced, laminated material. Due to the relatively stiff backing and encapsulation, SK-Series gages are less flexible than all other series and care must be exercised in handling and bonding. Some SK patterns can be supplied with modulus compensation (EMC) options.

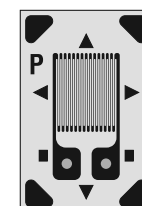

J5K SERIES

J5K gages are encapsulated, modified-Karma-alloy patterns specially constructed to improve gage performance at elevated temperatures. Because of the laminated polyimide-film backing and encapsulation, all J5K patterns are fully flexible without being brittle. Copper soldering pads (DP) are exposed for simplified lead connections. Some J5K gages can be supplied with modulus-compensation (EMC) options. For best high-temperature performance, J5K-Series gages should be installed with M-Bond 450 high-temperature adhesive.

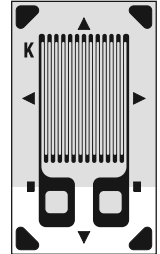

J5E SERIES

J5E gages are a family of platinum-tungsten-alloy patterns constructed with a thin, flexible polyimide backing. Sensing grids are fully encapsulated by a polyimide film overlay and include a preformed solder dot on each gage tab. With a gage factor more than double that of conventional strain gages, platinum-tungsten-alloy patterns provide standard transducer output levels at less than half the normal spring-element stress values. This allows for higher overload safety, increased fatigue life, and improved linearity in many transducer designs. A negative gage-factor-versus-temperature slope also provides modulus compensation in many types of steel transducer spring elements. A relatively high thermal output of platinum-tungsten alloy makes precision static measurements difficult.

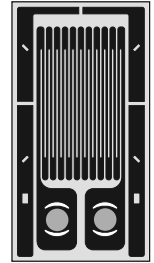

RE SERIES

RE gages are platinum-tungsten alloy patterns constructed with a thin, flexible, glass-fiber-reinforced polyimide film backing. Option E2 grid encapsulation is recommended for RE series gages. Solder tabs are fully exposed. Platinum-tungsten alloy is quite easy to solder using conventional rosin type fluxes. RE Series gages have the same beneficial high gage factor of J5E Series, and are useful in the same applications.

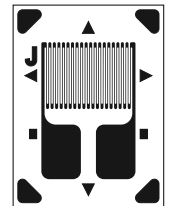

GAGE SERIES	TEMPERATURE RANGE		GAGE FACTOR (SEE NOTE)	FATIGUE LIFE	
	STATIC	DYNAMIC		STRAIN LEVEL IN μE	NUMBER OF CYCLES
N2A	-100° to +200°F [-75° to +95°C]	Same as Static	2.05 nom.	± 1500 1500	10^7 10^8 (2)
J2A	-100° to +200°F [-75° to +95°C]	Same as Static	2.05 nom.	± 1700 1700	10^6 10^7 (2)
EA	-100° to +200°F [-75° to +95°C]	[-320° to +350°F -195° to +175°C]	2.05 nom.	± 1500 1500	10^6 10^7 (2)
N2K	-100° to +200°F [-75° to +95°C]	Same as Static	2.1 nom. (1)	± 1800	10^7
N3K	-100° to +200°F [-75° to +95°C]	Same as Static	2.1 nom. (1)	± 1800	10^7
TK	-100° to +300°F [-75° to +150°C]	-320° to +400°F [-195° to +205°C]	2.1 nom. (1)	± 2000 2000	10^7 10^8 (2)
SK	-100° to +350°F [-75° to +175°C]	-320° to +450°F [-195° to +230°C]	2.1 nom. (1)	± 2000 2000	10^7 10^8 (2)
J5K	-100° to +400°F [-75° to +205°C]	-320° to +500°F [-195° to +260°C]	2.1 nom. (1)	± 2000 1800	10^7 10^8 (2)
J5E	-100° to +400°F [-75° to +205°C]	Same as Static	4.5 nom.	± 1500	10^8
RE	-100° to +400°F [-75° to +205°C]	Same as Static	4.5 nom.	± 1500	10^8

Notes:

- Transducer-Class® gages are supplied with nominal gage factor values that will vary slightly with pattern. They are not suitable for strain measurement in stress analysis applications. Request our Precision Strain Gages databook, or contact our Applications Engineering Department, for a complete listing of gages for precision strain measurement applications.

(1) Nominal gage factor is 2.3 for EMC options.

(2) Unidirectional strain.

Transducer-Class® Strain Gages

CREEP COMPENSATION

Commercial transducers regularly achieve a creep specification of less than $\pm 0.02\%$ of full scale (FS) for a 20-minute test. To attain this level on a high production basis, it is usually necessary to match the strain gage's creep characteristic to the spring element creep.

Most *Transducer-Class*® gages can be adjusted in design to exhibit either a positive or negative creep under load. Spring element materials exhibit only positive creep under load. (See figure below.)

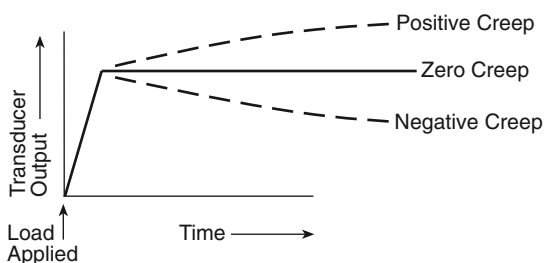

Since transducer creep depends on several variables such as spring element material, heat treatment, strain field, adhesive type and test temperature, it is not possible to predict the proper gage compensation necessary to achieve the best creep result.

Most of the gages in this catalog list one available creep compensation code. Since it is not possible to predetermine the creep characteristics of a particular transducer, it is suggested that the standard creep code be ordered in quantities sufficient to evaluate three or four transducers. Where creep levels are high enough to warrant correction, a different creep compensation, either more negative or more positive, depending on test results, can often be recommended.

A complicating factor in creep code selection is that while different gage patterns may list the same creep code, they do not necessarily exhibit the same creep behaviour. This is because the gage backing selection, gridline width and gage length also influence creep characteristics.

It should also be noted that this type of creep correction is generally limited to transducers exhibiting less than $\pm 0.1\%$ FS creep. Higher creep levels in the positive direction are often the result of poor spring element material selection. Negative creep values in excess of 0.1% FS generally are the result of a faulty gage installation.

MODULUS COMPENSATION (EMC) OPTION

Many of the K-alloy gages in this catalog are available in a special form which permits the gage factor change with temperature to be adjusted over a wide range during gage manufacture.

Properly matched to the transducer spring element, these EMC (Effective Modulus Compensation) gages can provide very good self-correction of changes in transducer span versus temperature. A compensation better than $\pm 0.0008\%/^{\circ}\text{F}$ [$\pm 0.0014\%/^{\circ}\text{C}$] can readily be achieved in many cases.

While this may at first appear to be the “ideal” strain gage for transducers, there are certain factors that should be considered prior to selecting EMC gages for a given application:

1. EMC gages cost more than other gages. In most cases the difference is great enough to offset the additional cost of span/temperature resistors.
2. EMC gages must be “matched” to the transducer spring material. Depending on the degree of compensation accuracy desired, the standard EMC options may not yield the “best fit” compensation on the spring material in use. In these cases, a special foil lot which possesses the desired compensation would be required. There is normally a minimum order requirement and set-up charge for special foil lots.
3. Transducer spring materials may not have batch-to-batch repeatability sufficient to maintain specifications when using the same EMC gages. New material lot testing is therefore necessary for high precision units.

Despite these limitations, EMC gages can often be advantageous for transducer manufacturers.

The following standard EMC options are available:

OPTION M1

Gage factor slope is -1.50% per 100°F [-2.70% per 100°C]. Provides span-versus-temperature compensation for many stainless steels.

OPTION M2

Gage factor slope is -2.35% per 100°F [-4.23% per 100°C]. Provides span-versus-temperature compensation for most aluminum alloys.

OPTION M3

Gage factor slope is -1.25% per 100°F [-2.25% per 100°C]. Provides span-versus-temperature compensation for many tool steels.

OPTION M4

Gage factor slope is -1.35% per 100°F [-2.43% per 100°C]. Provides “mid-range” compensation between M1 and M3.

Transducer-Class® Strain Gages

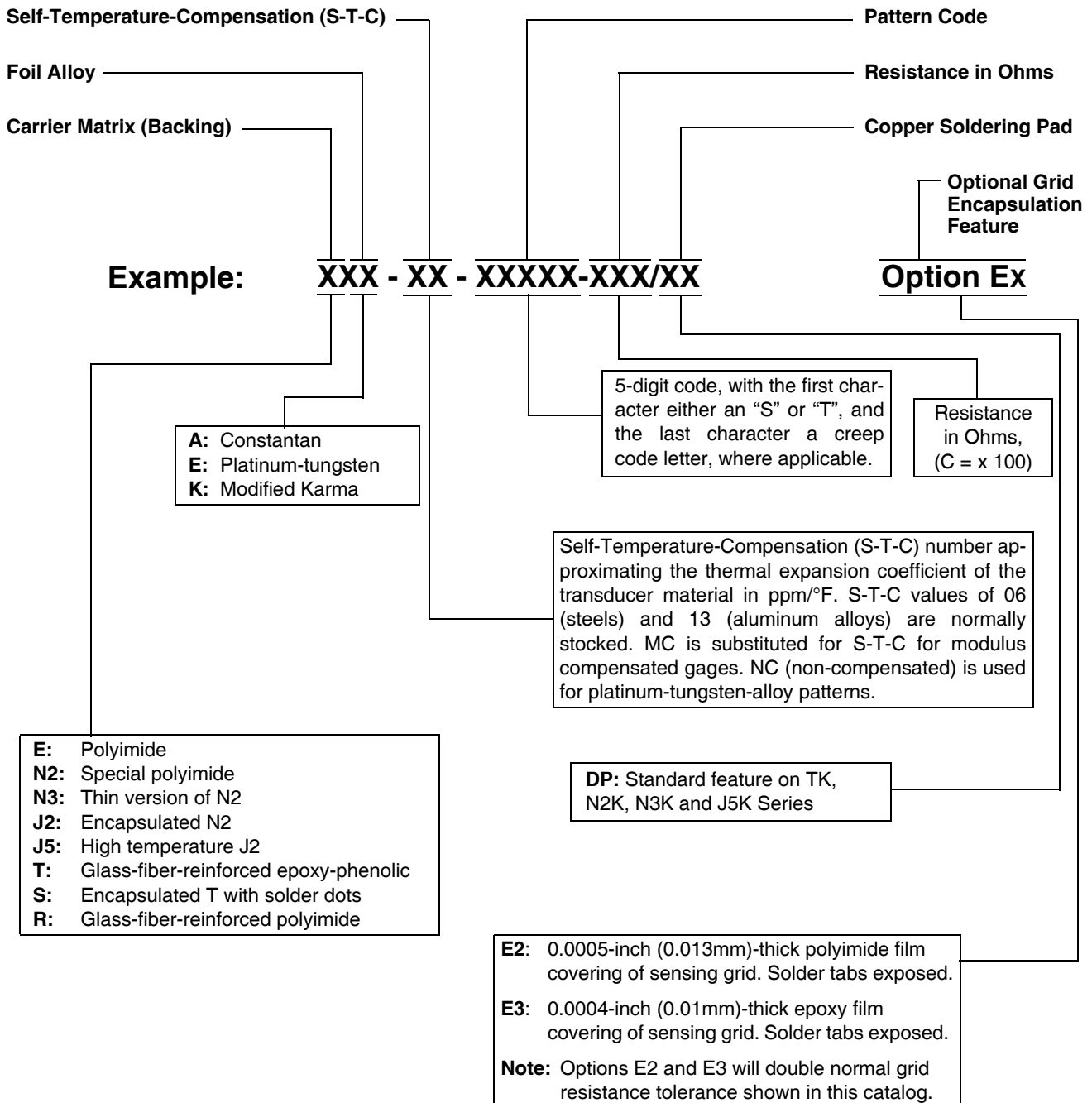

Transducer-Class® Strain Gages

GAGE PATTERN	Actual size shown. Enlarged when necessary for definition		GAGE DESIGNATION See Note 1	RES. IN OHMS	STANDARD CREEP CODE	ENCAPSULATION OPTION AVAILABLE
	DIMENSIONS	<div style="border: 1px solid black; padding: 2px; display: inline-block;">inch</div> <div style="border: 1px solid black; padding: 2px; display: inline-block;">millimeter</div>				

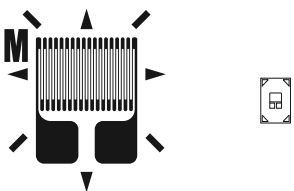
				Miniature high-resistance pattern.			
GAGE LENGTH	OVERALL LENGTH	GRID WIDTH	OVERALL WIDTH	N2K-XX-S118M-10C/DP TK-XX-S118M-10C/DP	1000 ± 0.2% 1000 ± 0.2%	M M	E2 E2
0.031	0.08	0.062	0.062				
0.78	2.0	1.57	1.57				
MATRIX SIZE	0.23 L x 0.16 W		5.8 L x 4.1 W				

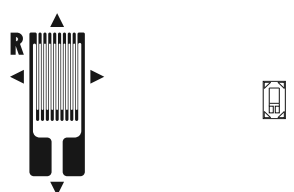
				Miniature high-resistance pattern.			
GAGE LENGTH	OVERALL LENGTH	GRID WIDTH	OVERALL WIDTH	N2K-XX-S065R-10C/DP TK-XX-S065R-10C/DP SK-XX-S065R-10C	1000 ± 0.15% 1000 ± 0.15% 1000 ± 0.3%	R R R	E2 E2
0.060	0.13	0.050	0.050				
1.52	3.3	1.27	1.27				
MATRIX SIZE	0.20 L x 0.11 W		5.0 L x 2.8 W				

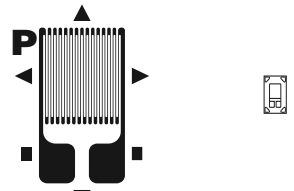
				General-purpose miniature patterns.			
NOTE: Matrix and overall length of J2A and J5K patterns will be slightly longer than dimensions shown.							
GAGE LENGTH	OVERALL LENGTH	GRID WIDTH	OVERALL WIDTH	N2A-XX-S071P-350 J2A-XX-S183P-350 N2K-XX-S075P-350/DP TK-XX-S075P-350/DP J5K-XX-S104P-350/DP SK-XX-S075P-350	350 ± 0.1% 350 ± 0.3% 350 ± 0.15% 350 ± 0.15% 350 ± 0.3% 350 ± 0.3%	P P P P P P	E2 E2
0.062	0.12	0.062	0.062				
1.57	3.1	1.57	1.57				
MATRIX SIZE	0.19 L x 0.12 W		4.8 L x 3.1 W				

Note 1: Products shown in bold are not RoHS compliant.

Transducer-Class® Strain Gages

GAGE PATTERN	Actual size shown. Enlarged when necessary for definition	GAGE DESIGNATION See Note 1	RES. IN OHMS	STANDARD CREEP CODE	ENCAPSU- LATION OPTION AVAILABLE
	DIMENSIONS				

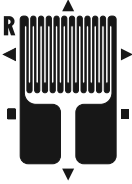
				The most popular small gage pattern.			
GAGE LENGTH	OVERALL LENGTH	GRID WIDTH	OVERALL WIDTH	N2A-XX-S148P-120 N2A-XX-S106N-175 N2A-XX-T001N-350 N2A-XX-T010P-10C J2A-XX-S148P-120 J2A-XX-S106N-175 J2A-XX-S047K-350 J2A-XX-S110K-10C N2K-XX-S123R-175/DP N2K-XX-T009N-350/DP N2K-XX-S072R-10C/DP TK-XX-S123R-175/DP TK-XX-T009Q-350/DP TK-XX-S072R-10C/DP J5K-XX-S103Q-350/DP SK-XX-S074R-350 SK-XX-S072R-10C	120 ± 0.15% 175 ± 0.15% 350 ± 0.15% 1000 ± 0.15% 120 ± 0.3% 175 ± 0.3% 350 ± 0.3% 1000 ± 0.3% 175 ± 0.15% 350 ± 0.15% 1000 ± 0.15% 175 ± 0.15% 350 ± 0.15% 1000 ± 0.15% 350 ± 0.3% 350 ± 0.3% 1000 ± 0.3%	P N N P P N K K R R R R R R R R R R R	E2 E2 E2 E2 E2 E2 E2 E2 E2
0.060	0.15	0.100	0.100				
1.52	3.8	2.54	2.54				
MATRIX SIZE	0.22 L x 0.16 W		5.6 L x 4.1 W				

				Higher-power-dissipation versions of the T001/T009 patterns.			
GAGE LENGTH	OVERALL LENGTH	GRID WIDTH	OVERALL WIDTH	N2A-XX-T002Q-350 N2K-XX-T003Q-350/DP TK-XX-T003Q-350/DP	350 ± 0.15% 350 ± 0.15% 350 ± 0.15%	Q Q Q	E2 E2 E2
0.060	0.17	0.180	0.180				
1.52	4.3	4.57	4.57				
MATRIX SIZE	0.24 L x 0.24 W		6.1 L x 6.1 W				

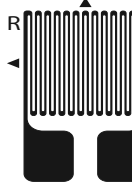
				One of the most popular gage sizes.			
				†Overall length on S078/S080 is 0.25 in (6.4mm). Matrix length will also increase slightly.			
GAGE LENGTH	OVERALL LENGTH	GRID WIDTH	OVERALL WIDTH	N2A-XX-S107N-120 N2A-XX-T004R-350 N2A-XX-T096R-500 N2A-XX-S108N-10C J2A-XX-S108N-10C N2K-XX-T005R-350/DP N2K-XX-S163R-500/DP N2K-XX-S078W-10C/DP TK-XX-T005R-350/DP TK-XX-S078W-10C/DP SK-XX-S080W-350 SK-XX-S078W-10C	120 ± 0.15% 350 ± 0.15% 500 ± 0.15% 1000 ± 0.15% 1000 ± 0.3% 350 ± 0.15% 500 ± 0.15% 1000 ± 0.15% 350 ± 0.15% 1000 ± 0.15% 350 ± 0.15% 1000 ± 0.15% 350 ± 0.3% 1000 ± 0.3%	N R R N N R R W R W W W	E2 E2 E2 E2 E2 E2 E2 E2 E2
0.125	0.23†	0.125	0.125				
3.18	5.8†	3.18	3.18				
MATRIX SIZE	0.29 L x 0.19 W		7.4 L x 4.8 W				

Note 1: Products shown in bold are not RoHS compliant.

Linear Patterns - Single Grid

Transducer-Class® Strain Gages

GAGE PATTERN	Actual size shown. Enlarged when necessary for definition	GAGE DESIGNATION See Note 1	RES. IN OHMS	STANDARD CREEP CODE	ENCAPSU- LATION OPTION AVAILABLE
	DIMENSIONS				

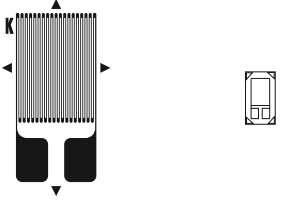
				One of the most popular gage sizes.			
GAGE LENGTH	OVERALL LENGTH	GRID WIDTH	OVERALL WIDTH	J2A-XX-S033P-350 J2A-XX-S182K-10C N2K-XX-S081P-20C/DP TK-XX-S081P-20C/DP J5K-XX-S100P-350/DP	350 ± 0.3% 1000 ± 0.3% 2000 ± 0.3% 2000 ± 0.3% 350 ± 0.3%	P K P P P	E2 E2
0.125	0.21	0.100	0.100				
3.18	5.6	2.54	2.54				
MATRIX SIZE	0.28 L x 0.16 W	7.1 L x 4.1 W					

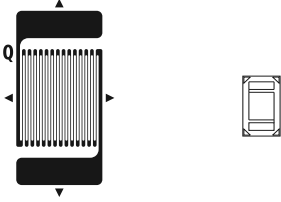
				Tabs at both ends of grid for simplified wiring on some transducer designs.			
GAGE LENGTH	OVERALL LENGTH	GRID WIDTH	OVERALL WIDTH	N2A-XX-S044Q-350	350 ± 0.15%	Q	E2
0.125	0.255	0.125	0.125				
3.18	6.48	3.18	3.18				
MATRIX SIZE	0.32 L x 0.19 W	8.1 L x 4.7 W					

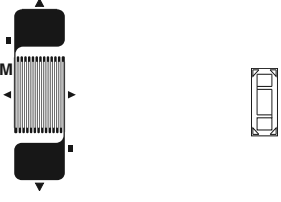
				Narrow, encapsulated version of S044.			
GAGE LENGTH	OVERALL LENGTH	GRID WIDTH	OVERALL WIDTH	J2A-XX-S113M-350	350 ± 0.3%	M	
0.110	0.285	0.080	0.080				
2.82	7.31	2.03	2.03				
MATRIX SIZE	0.34 L x 0.14 W	8.7 L x 3.6 W					

Note 1: Products shown in bold are not RoHS compliant.

Transducer-Class® Strain Gages

GAGE PATTERN	Actual size shown. Enlarged when necessary for definition	GAGE DESIGNATION See Note 1	RES. IN OHMS	STANDARD CREEP CODE	ENCAPSU- LATION OPTION AVAILABLE
	DIMENSIONS				

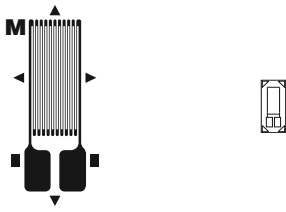
				Narrow-grid version of T004/T005.			
GAGE LENGTH	OVERALL LENGTH	GRID WIDTH	OVERALL WIDTH				
0.125	0.20	0.060	0.070				
3.18	5.1	1.52	1.78				
MATRIX SIZE	0.27 L x 0.12 W		6.9 L x 3.0 W				
				N2A-XX-T019M-350	350 ± 0.15%	M	E2
				J2A-XX-S038M-350	350 ± 0.3%	M	
				N2K-XX-T020T-350/DP	350 ± 0.15%	T	E2
				TK-XX-T020T-350/DP	350 ± 0.15%	T	E2

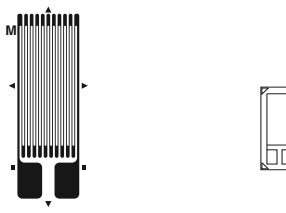
				Longer grid for strain averaging or where higher power dissipation is required.			
GAGE LENGTH	OVERALL LENGTH	GRID WIDTH	OVERALL WIDTH				
0.250	0.37	0.125	0.125				
6.35	9.4	3.18	3.18				
MATRIX SIZE	0.44 L x 0.19 W		11.2 L x 4.8 W				
				N2A-XX-T007R-350	350 ± 0.15%	R	E2
				J2A-XX-S109M-350	350 ± 0.3%	M	
				N2K-XX-T008R-350/DP	350 ± 0.15%	R	E2
				TK-XX-T008R-350/DP	350 ± 0.15%	R	E2

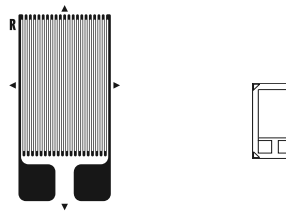
				Large grid and high resistance permit higher-than-normal excitation voltage.			
GAGE LENGTH	OVERALL LENGTH	GRID WIDTH	OVERALL WIDTH				
0.250	0.36	0.175	0.175				
6.35	9.1	4.45	4.45				
MATRIX SIZE	0.42 L x 0.24 W		10.7 L x 6.1 W				
				N2A-XX-S051R-10C	1000 ± 0.15%	R	E2

Note 1: Products shown in bold are not RoHS compliant.

Transducer-Class® Strain Gages

GAGE PATTERN	Actual size shown. Enlarged when necessary for definition	GAGE DESIGNATION See Note 1	RES. IN OHMS	STANDARD CREEP CODE	ENCAPSULATION OPTION AVAILABLE
	DIMENSIONS				

				Small dual-element gage designed for bending-beam transducers.			
GAGE LENGTH	OVERALL LENGTH	GRID WIDTH	OVERALL WIDTH				
0.060	0.12	0.065	0.150	N2A-XX-S061P-350	350 ± 0.2%	P	E2
				N2K-XX-S085N-350/DP	350 ± 0.2%	N	E2
				N2K-XX-S098N-10C/DP	1000 ± 0.2%	N	E2
1.52	3.1	1.65	3.81	TK-XX-S085N-350/DP	350 ± 0.2%	N	E2
				TK-XX-S098N-10C/DP	1000 ± 0.2%	N	E2
MATRIX SIZE	0.19 L x 0.21 W	4.8 L x 5.3 W		SK-XX-S085N-350	350 ± 0.4%	N	

				Compact dual-element pattern for bending-beam transducers.			
GAGE LENGTH	OVERALL LENGTH	GRID WIDTH	OVERALL WIDTH				
0.075	0.17	0.100	0.210				
1.90	4.2	2.54	5.33				
MATRIX SIZE	0.24 L x 0.25 W	6.1 L x 6.4 W		J2A-XX-S181N-350	350 ± 0.4%	N	
				J2A-XX-S185N-10C	1000 ± 0.4%	N	

				Half-bridge common-tab pattern. Grid centerline spacing 0.215 in (5.46 mm).			
GAGE LENGTH	OVERALL LENGTH	GRID WIDTH	OVERALL WIDTH				
0.060	0.29	0.100	0.100				
1.52	7.4	2.54	2.54				
MATRIX SIZE	0.37 L x 0.16 W	9.3 L x 4.1 W		N2A-XX-S141K-175	175 ± 0.2%	K	E2
				N2A-XX-T028K-350	350 ± 0.2%	K	E2
				N2A-XX-S124N-10C	1000 ± 0.2%	N	E2

Note 1: Products shown in bold are not RoHS compliant.

Transducer-Class® Strain Gages

GAGE PATTERN	Actual size shown. Enlarged when necessary for definition	GAGE DESIGNATION See Note 1	RES. IN OHMS	STANDARD CREEP CODE	ENCAPSU- LATION OPTION AVAILABLE
	DIMENSIONS				

				Half-bridge common-tab pattern. Grid centerline spacing 0.215 in (5.46mm).			
GAGE LENGTH	OVERALL LENGTH	GRID WIDTH	OVERALL WIDTH	N2K-XX-T011Q-350/DP TK-XX-T011Q-350/DP	350 ± 0.2% 350 ± 0.2%	Q Q	E2 E2
0.060	0.29	0.180	0.180				
1.52	7.4	4.57	4.57				
MATRIX SIZE	0.37 L x 0.24 W		9.3 L x 6.1 W				

				Half-bridge common-tab pattern. Grid centerline spacing 0.415 in (10.54mm). †BAL is balanced to ±0.2%, but RG is 350 ohms ± 15%.			
GAGE LENGTH	OVERALL LENGTH	GRID WIDTH	OVERALL WIDTH	N2A-XX-T012R-350 N2A-XX-S1414-35B N2K-XX-T016Q-350/DP TK-XX-T016Q-350/DP	350 ± 0.2% BAL ± 0.2%† 350 ± 0.2% 350 ± 0.2%	R N/A Q Q	E2 E2 E2 E2
0.060	0.49	0.100	0.100				
1.52	12.4	2.54	2.54				
MATRIX SIZE	0.57 L x 0.16 W		14.5 L x 4.1 W				

				Dual-element pattern for narrow bending beams. Grid centerline spacing 0.083 in (2.1mm).			
GAGE LENGTH	OVERALL LENGTH	GRID WIDTH	OVERALL WIDTH	N2A-XX-S1452-350 N2K-XX-S1451-350/DP TK-XX-S1451-350/DP	350 ± 0.2% 350 ± 0.2% 350 ± 0.2%	N/A N/A N/A	E2 E2 E2
0.062	0.233	0.062	0.062				
1.59	5.97	1.59	1.59				
MATRIX SIZE	0.28 L x 0.12 W		7.2 L x 3.1 W				

Note 1: Products shown in bold are not RoHS compliant.

Linear Patterns - Dual Grid

Transducer-Class® Strain Gages

GAGE PATTERN	Actual size shown. Enlarged when necessary for definition		GAGE DESIGNATION See Note 1	RES. IN OHMS	STANDARD CREEP CODE	ENCAPSULATION OPTION AVAILABLE
	DIMENSIONS	inch millimeter				

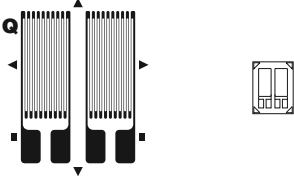
				Dual-element gages widely used on bending-beam transducers.		
GAGE LENGTH	OVERALL LENGTH	GRID WIDTH	OVERALL WIDTH			
0.125	0.20	0.065	0.150	N2A-XX-T006Q-350	350 ± 0.2%	Q
				J2A-XX-S035M-350	350 ± 0.4%	M
				N2K-XX-S082R-350/DP	350 ± 0.2%	R
				N2K-XX-T092P-10C/DP	1000 ± 0.2%	P
				TK-XX-S082R-350/DP	350 ± 0.2%	R
				TK-XX-T092P-10C/DP	1000 ± 0.2%	P
MATRIX SIZE	0.27 L x 0.21 W		6.9 L x 5.3 W			
						E2

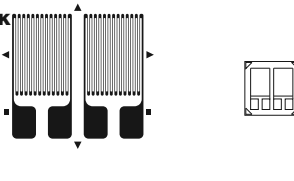
				Wider-grid versions of T006/S035 patterns.		
GAGE LENGTH	OVERALL LENGTH	GRID WIDTH	OVERALL WIDTH			
0.125	0.21	0.100	0.220	N2A-XX-S138K-350	350 ± 0.2%	K
				N2A-XX-S139N-10C	1000 ± 0.2%	N
				J2A-XX-S138K-350	350 ± 0.4%	K
				J2A-XX-S139N-10C	1000 ± 0.4%	N
MATRIX SIZE	0.28 L x 0.28 W		7.1 L x 7.1 W			
						E2

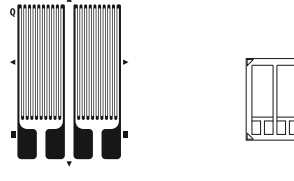
				Widely used on bending-beam transducers where greater power dissipation is required. J2A pattern slightly longer and wider.		
GAGE LENGTH	OVERALL LENGTH	GRID WIDTH	OVERALL WIDTH			
0.250	0.34	0.100	0.215			
MATRIX SIZE	0.41 L x 0.28 W		10.4 L x 7.1 W			
				N2A-XX-T026P-350	350 ± 0.2%	P
				J2A-XX-S087Q-350	350 ± 0.4%	Q
						E2

Note 1: Products shown in bold are not RoHS compliant.

Transducer-Class® Strain Gages

GAGE PATTERN	Actual size shown. Enlarged when necessary for definition.	GAGE DESIGNATION See Note 1	RES. IN OHMS	STANDARD CREEP CODE	ENCAPSU- LATION OPTION AVAILABLE
	DIMENSIONS				

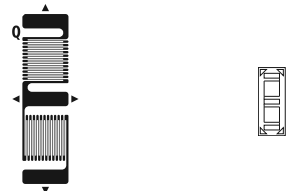
				Often used on small column transducers.	
GAGE LENGTH	OVERALL LENGTH	GRID WIDTH	OVERALL WIDTH	N2A-XX-S063Q-350	350 ± 0.2%
0.062	0.295	0.080	0.080		
1.57	7.49	2.03	2.03		
MATRIX SIZE	0.36 L x 0.14 W		9.0 L x 3.6 W	Q*	E2

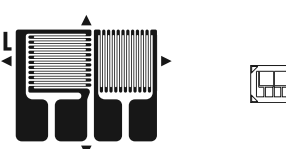
				General-purpose 90° tee rosette.	
GAGE LENGTH	OVERALL LENGTH	GRID WIDTH	OVERALL WIDTH	N2A-XX-S064L-350	350 ± 0.2%
0.062	0.133	0.075	0.168		
1.57	3.38	1.91	4.27		
MATRIX SIZE	0.24 L x 0.25 W		4.9 L x 5.8 W	L*	E2

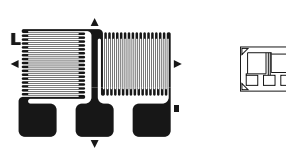
				Encapsulated 90° tee rosette.	
GAGE LENGTH	OVERALL LENGTH	GRID WIDTH	OVERALL WIDTH	J2A-XX-S114L-350 J2A-XX-S152M-10C	350 ± 0.4% 1000 ± 0.4%
0.080	0.170	0.110	0.240		
2.03	4.32	2.79	6.10		
MATRIX SIZE	0.23 L x 0.30 W		5.9 L x 7.6 W	L M	

*Only creep code available for this gage type.

Note 1: All products are RoHS compliant.

90° Patterns - Dual Grid

Transducer-Class® Strain Gages

GAGE PATTERN	Actual size shown. Enlarged when necessary for definition.	GAGE DESIGNATION See Note 1	RES. IN OHMS	STANDARD CREEP CODE	ENCAPSULATION OPTION AVAILABLE
	DIMENSIONS				

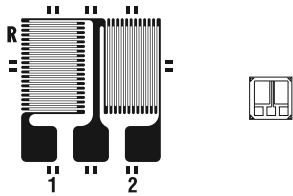
				Designed for low-cost, half-bridge transducers. †BAL is balanced to ± 0.2%, but RG is 350 ohms ± 15%. ‡BAL is balanced to ± 0.2%, but RG is 1000 ohms ± 15%.			
GAGE LENGTH	OVERALL LENGTH	GRID WIDTH	OVERALL WIDTH				
GRID 1 0.060	0.180	GRID 1 0.120	0.175				
1.52	4.57	3.05	4.45				
MATRIX SIZE	0.22 L x 0.22 W		5.6 L x 5.6 W				
				N2A-XX-S153R-35B N2A-XX-S150R-1KB	BAL ± 0.2%† BAL ± 0.2%‡	R* R*	E2 E2

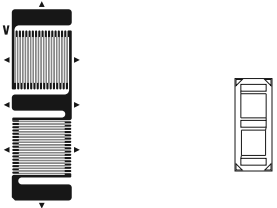
				Often used on column transducers.			
GAGE LENGTH	OVERALL LENGTH	GRID WIDTH	OVERALL WIDTH				
0.100	0.415	0.130	0.130				
2.54	10.54	3.30	3.30				
MATRIX SIZE	0.48 L x 0.19 W		12.2 L x 4.8 W				
				N2K-XX-S165V-10C/DP	1000 ± 0.2%	V	E2

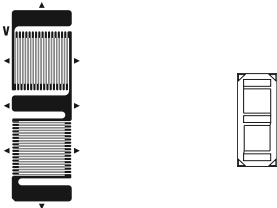
				Often used on column transducers.			
GAGE LENGTH	OVERALL LENGTH	GRID WIDTH	OVERALL WIDTH				
0.100	0.415	0.130	0.130				
2.54	10.54	3.30	3.30				
MATRIX SIZE	0.48 L x 0.19 W		12.2 L x 4.8 W				
				N2A-XX-S053P-350	350 ± 0.2%	P	E2

*Only creep code available for this gage type.

Note 1: All products are RoHS compliant.

Transducer-Class® Strain Gages

GAGE PATTERN	Actual size shown. Enlarged when necessary for definition.		GAGE DESIGNATION See Note 1	RES. IN OHMS	STANDARD CREEP CODE	ENCAPSULATION OPTION AVAILABLE
	DIMENSIONS	<input type="checkbox"/> inch <input type="checkbox"/> millimeter				

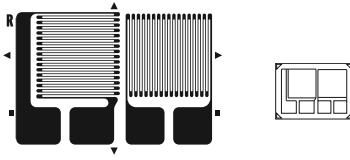
				General-purpose 90° tee rosette.			
GAGE LENGTH	OVERALL LENGTH	GRID WIDTH	OVERALL WIDTH	N2A-XX-S054Y-350 N2K-XX-S145R-10C/DP TK-XX-S145R-10C/DP	350 ± 0.2% 1000 ± 0.2% 1000 ± 0.2%	Y R R	E2 E2 E2
0.125	0.230	0.150	0.340				
3.18	5.84	3.81	8.64				
MATRIX SIZE	0.29 L x 0.40 W		7.4 L x 10.2 W				

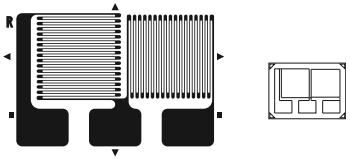
				Three-tab version of S145R pattern.			
GAGE LENGTH	OVERALL LENGTH	GRID WIDTH	OVERALL WIDTH	N2K-XX-S146R-10C/DP TK-XX-S146R-10C/DP	1000 ± 0.2% 1000 ± 0.2%	R R	E2 E2
0.125	0.230	0.150	0.340				
3.18	5.84	3.81	8.64				
MATRIX SIZE	0.29 L x 0.40 W		7.4 L x 10.2 W				

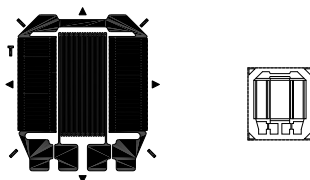
				Used on high-accuracy column load cells. (1) Gage length is 0.200 in (5.1mm). (2) Transverse gage length is 0.050 in (1.27mm).			
GAGE LENGTH	OVERALL LENGTH	GRID WIDTH	OVERALL WIDTH	N2A-XX-S167R-350 N2K-XX-S015T-350/DP N2K-XX-S184T-10C/DP TK-XX-S015T-350/DP TK-XX-S184T-10C/DP	350 ± 0.2% 350 ± 0.2% 1000 ± 0.2% 350 ± 0.2% 1000 ± 0.2%	R* T* T* T* T*	E2 E2 E2 E2 E2
(1)	0.325	(2)	0.270				
(1)	8.26	(2)	6.86				
MATRIX SIZE	0.38 L x 0.33 W		9.6 L x 8.4 W				

*Only creep code available for this gage type.

Note 1: All products are RoHS compliant.

Shear Patterns - Single Grid

Transducer-Class® Strain Gages

GAGE PATTERN	Actual size shown. Enlarged when necessary for definition.	GAGE DESIGNATION See Note 1	RES. IN OHMS	STANDARD CREEP CODE	ENCAPSULATION OPTION AVAILABLE
	DIMENSIONS				

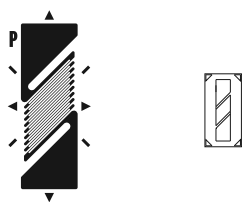
				Single-element miniature shear pattern. †S199 and S112 patterns have 0.320 in (8.2mm) overall length and slightly longer matrix.			
GAGE LENGTH	OVERALL LENGTH	GRID WIDTH	OVERALL WIDTH				
0.075	0.220†	0.060	0.075				
1.91	5.59†	1.52	1.91				
MATRIX SIZE	0.28 L x 0.14 W		7.1 L x 3.6 W				
				N2A-XX-S069P-350 J2A-XX-S199N-350 N2K-XX-S112Q-350/DP J5K-XX-S112Q-350/DP	350 ± 0.15% 350 ± 0.3% 350 ± 0.15% 350 ± 0.3%	P N Q Q	E3 E3

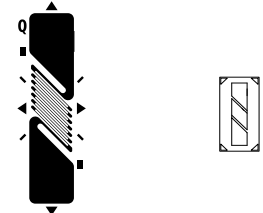
				Right-hand version of S112Q pattern.			
GAGE LENGTH	OVERALL LENGTH	GRID WIDTH	OVERALL WIDTH				
0.075	0.320	0.060	0.075				
1.90	8.13	1.52	1.90				
MATRIX SIZE	0.38 L x 0.19 W		9.6 L x 4.8 W				
				N2K-XX-S223Q-350/DP J5K-XX-S223Q-350	350 ± 0.15% 350 ± 0.3%	Q Q	E3

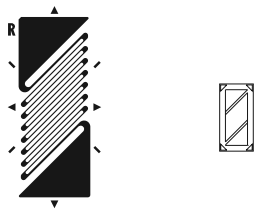
				Single-element shear patterns. Some slight dimensional variation with pattern. †J2A pattern has 0.42 in (10.7mm) overall length and slightly longer matrix.			
GAGE LENGTH	OVERALL LENGTH	GRID WIDTH	OVERALL WIDTH				
0.125	0.290†	0.105	0.105				
3.18	7.37†	2.67	2.67				
MATRIX SIZE	0.36 L x 0.18 W		9.1 L x 4.6 W				
				N2A-XX-S028T-175 N2A-XX-S088K-350 J2A-XX-S117R-175 J2A-XX-S091K-350 N2K-XX-S026Y-175/DP N2K-XX-S090R-350/DP N2K-XX-S089K-10C/DP TK-XX-S026Y-175/DP TK-XX-S090R-350/DP TK-XX-S089K-10C/DP	175 ± 0.15% 350 ± 0.15% 175 ± 0.3% 350 ± 0.3% 175 ± 0.15% 350 ± 0.15% 1000 ± 0.15% 175 ± 0.15% 350 ± 0.15% 1000 ± 0.15%	T K R K Y R K Y R K	E3 E3 E3 E3 E3 E3

Note 1: All products are RoHS compliant.

Transducer-Class® Strain Gages

GAGE PATTERN	Actual size shown. Enlarged when necessary for definition.		GAGE DESIGNATION See Note 1	RES. IN OHMS	STANDARD CREEP CODE	ENCAPSULATION OPTION AVAILABLE
	DIMENSIONS	<input type="checkbox"/> inch <input type="checkbox"/> millimeter				

				Right-hand versions of S091K and S090R patterns. †J2A pattern has 0.42 in (10.7mm) overall length and slightly longer matrix.			
GAGE LENGTH	OVERALL LENGTH	GRID WIDTH	OVERALL WIDTH	J2A-XX-S149K-350 N2K-XX-S142R-350/DP TK-XX-S142R-350/DP	350 ± 0.3% 350 ± 0.15% 350 ± 0.15%	K R R	E3
0.125	0.290†	0.100	0.115				
3.18	7.37†	2.54	2.92				
MATRIX SIZE	0.36 L x 0.18 W		9.1 L x 4.6 W				

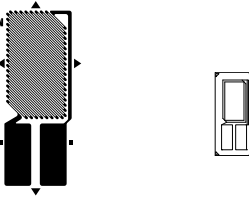
				Single-element shear pattern with tabs on one end.			
GAGE LENGTH	OVERALL LENGTH	GRID WIDTH	OVERALL WIDTH	J2A-XX-S177N-350	350 ± 0.3%	N	
0.141	0.361	0.198	0.132				
3.58	9.17	5.03	3.35				
MATRIX SIZE	0.43 L x 0.20 W		10.9 L x 5.1 W				

Note 1: All products are RoHS compliant.

Transducer-Class® Strain Gages

GAGE PATTERN	Actual size shown. Enlarged when necessary for definition.	GAGE DESIGNATION See Note 1	RES. IN OHMS	STANDARD CREEP CODE	ENCAPSULATION OPTION AVAILABLE
	DIMENSIONS				

				Smaller version of T029/T030.				
GAGE LENGTH	OVERALL LENGTH	GRID WIDTH	OVERALL WIDTH					
0.075	0.220	0.060	0.170	N2A-XX-S203P-175	175 ± 0.2%	P	E3	
1.91	5.59	1.52	4.32	N2A-XX-T031P-350	350 ± 0.2%	P	E3	
MATRIX SIZE	0.28 L x 0.23 W		7.1 L x 5.8 W		N2K-XX-T032P-350/DP	350 ± 0.2%	P	E3
				N2K-XX-S137Q-10C/DP	1000 ± 0.2%	Q	E3	
				TK-XX-T032P-350/DP	350 ± 0.2%	P		
				TK-XX-S137Q-10C/DP	1000 ± 0.2%	Q		

				Encapsulated version of T031/T032.			
GAGE LENGTH	OVERALL LENGTH	GRID WIDTH	OVERALL WIDTH				
0.075	0.22	0.060	0.190				
1.91	5.6	1.52	4.83	J2A-XX-S036R-350	350 ± 0.4%	R	
MATRIX SIZE	0.28 L x 0.25 W		7.1 L x 6.4 W		J5K-XX-S1448-350/DP	350 ± 0.4%	N/A

				Three-tab version of S036 pattern.			
GAGE LENGTH	OVERALL LENGTH	GRID WIDTH	OVERALL WIDTH				
0.075	0.216	0.060	0.190				
1.91	5.49	1.52	4.83	J2A-XX-S254R-350	350 ± 0.4%	R	
MATRIX SIZE	0.28 L x 0.25 W		7.1 L x 6.4 W				

Note 1: All products are RoHS compliant.

Transducer-Class® Strain Gages

GAGE PATTERN	Actual size shown. Enlarged when necessary for definition.	GAGE DESIGNATION See Note 1	RES. IN OHMS	STANDARD CREEP CODE	ENCAPSU- LATION OPTION AVAILABLE
	DIMENSIONS				

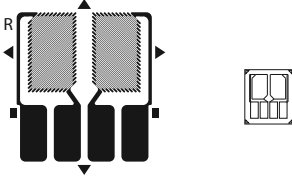
				Rectangular-grid, 1000-ohm version of S036 pattern.			
GAGE LENGTH	OVERALL LENGTH	GRID WIDTH	OVERALL WIDTH	J2A-XX-S173R-10C	1000 ± 0.4%	R	
0.085	0.226	0.114	0.200				
2.16	5.74	2.89	5.08				
MATRIX SIZE	0.28 L x 0.25 W	7.1 L x 6.4 W					

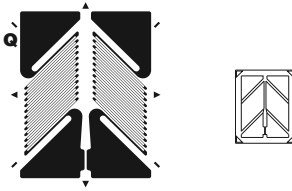
				Dual-element patterns for shear or torque transducers.			
GAGE LENGTH	OVERALL LENGTH	GRID WIDTH	OVERALL WIDTH	N2A-XX-T029Q-350 N2A-XX-S096H-10C N2K-XX-T030R-350/DP N2K-XX-S083R-10C/DP TK-XX-T030R-350/DP TK-XX-S083R-10C/DP	350 ± 0.2% 1000 ± 0.2% 350 ± 0.2% 1000 ± 0.2% 350 ± 0.2% 1000 ± 0.2%	Q H R R R	E3 E3 E3 E3
0.125	0.318	0.10	0.250				
3.18	8.08	2.54	6.35				
MATRIX SIZE	0.38 L x 0.31 W	9.6 L x 7.9 W					

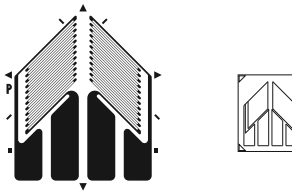
				Encapsulated versions of T029/S096.			
GAGE LENGTH	OVERALL LENGTH	GRID WIDTH	OVERALL WIDTH	J2A-XX-S101P-175 J2A-XX-S034P-350 J2A-XX-S122P-10C	175 ± 0.4% 350 ± 0.4% 1000 ± 0.4%	P P P	
0.125	0.33	0.100	0.275				
3.18	8.4	2.54	6.99				
MATRIX SIZE	0.40 L x 0.34 W	10.1 L x 8.5 W					

Note 1: All products are RoHS compliant.

Shear Patterns - Dual Grid

Transducer-Class® Strain Gages

GAGE PATTERN	Actual size shown. Enlarged when necessary for definition.		GAGE DESIGNATION See Note 1	RES. IN OHMS	STANDARD CREEP CODE	ENCAPSULATION OPTION AVAILABLE
	DIMENSIONS	<input type="checkbox"/> inch <input type="checkbox"/> millimeter				

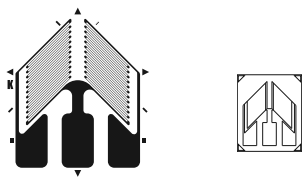
				Three-tab version of S034 pattern.		
GAGE LENGTH	OVERALL LENGTH	GRID WIDTH	OVERALL WIDTH	J2A-XX-S111K-350	350 ± 0.4%	K
0.125	0.33	0.100	0.275			
3.18	8.4	2.54	6.99			
MATRIX SIZE	0.40 L x 0.34 W		10.1 L x 8.5 W			

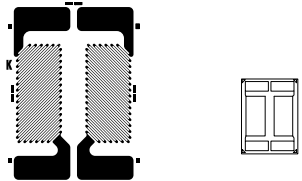
				Encapsulated dual-shear pattern with tabs at both ends of pattern.		
GAGE LENGTH	OVERALL LENGTH	GRID WIDTH	OVERALL WIDTH	J2A-XX-S245K-350	350 ± 0.4%	K
0.125	0.360	0.201	0.252			
3.18	9.14	5.10	6.40			
MATRIX SIZE	0.39 L x 0.29 W		9.9 L x 7.4 W			

Note 1: All products are RoHS compliant.

Transducer-Class® Strain Gages

GAGE PATTERN	Actual size shown. Enlarged when necessary for definition.		GAGE DESIGNATION See Note 1	RES. IN OHMS	STANDARD CREEP CODE	ENCAPSULATION OPTION AVAILABLE
	DIMENSIONS	<div style="border: 1px solid black; padding: 2px; display: inline-block;">inch</div> <div style="border: 1px solid black; padding: 2px; display: inline-block;">millimeter</div>				

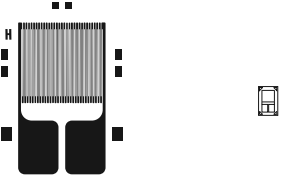
				Widely used in 4-20mA transmitters and battery-operated transducers. †J5K pattern has 0.125 in (3.2mm) overall length and slightly longer matrix.			
GAGE LENGTH	OVERALL LENGTH	GRID WIDTH	OVERALL WIDTH	N3K-XX-S022H-50C/DP J5K-XX-S105H-50C/DP SK-XX-S022H-50C	5000 ± 0.3% 5000 ± 0.6% 5000 ± 0.6%	H H H	E2
0.050	0.11†	0.065	0.065				
1.27	2.8†	1.65	1.65				
MATRIX SIZE	0.15 L x 0.10 W		3.8 L x 2.5 W				

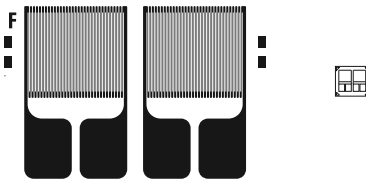
				Same applications as S022X above.			
GAGE LENGTH	OVERALL LENGTH	GRID WIDTH	OVERALL WIDTH	N3K-XX-S024F-50C/DP	5000 ± 0.3%	F	E2
0.050	0.11	0.065	0.140				
1.27	2.8	1.65	3.56				
MATRIX SIZE	0.16 L x 0.18 W		4.1 L x 4.6 W				

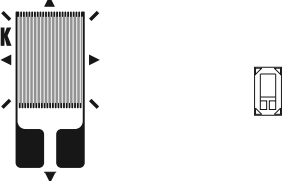
				Larger grid pattern than S022.			
GAGE LENGTH	OVERALL LENGTH	GRID WIDTH	OVERALL WIDTH	N2K-XX-S076K-45C/DP TK-XX-S076K-45C/DP SK-XX-S076K-45C	4500 ± 0.2% 4500 ± 0.2% 4500 ± 0.4%	K K K	E2 E2
0.100	0.18	0.080	0.080				
2.54	4.6	2.03	2.03				
MATRIX SIZE	0.25 L x 0.14 W		6.4 L x 3.6 W				

Note 1: Products shown in bold are not RoHS compliant.

Transducer-Class® Strain Gages

GAGE PATTERN	Actual size shown. Enlarged when necessary for definition.		GAGE DESIGNATION See Note 1	RES. IN OHMS	STANDARD CREEP CODE	ENCAPSULATION OPTION AVAILABLE
	DIMENSIONS	inch millimeter				

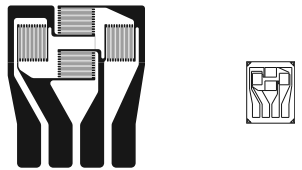
				Low-cost full-bridge gage for bending-beam transducers. †BAL is balanced to $\pm 0.4mV/V$, but RG is 350 ohms $\pm 15\%$		
GAGE LENGTH	OVERALL LENGTH	GRID WIDTH	OVERALL WIDTH	J2A-XX-S1425-35B	BAL ± 0.4 †	N/A
0.050	0.260	0.050	0.220			
1.28	6.66	1.28	5.64			
MATRIX SIZE	0.32 L x 0.25 W		8.2 L x 6.4 W			

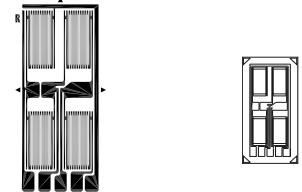
				Compact full-bridge pattern for use on small, double-bending beams. Axial grid centerline spacing 0.250 in (6.35 mm).			
GAGE LENGTH	OVERALL LENGTH	GRID WIDTH	OVERALL WIDTH	N2A-XX-S055R-350	350 $\pm 0.2\%$	R	E2
0.125	0.465	0.060	0.189				
3.18	11.81	1.52	4.80				
MATRIX SIZE	0.54 L x 0.26 W		13.7 L x 6.6 W				

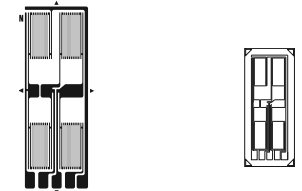
				Similar to S055R pattern except axial grid centerline spacing 0.330 in (8.38mm).			
GAGE LENGTH	OVERALL LENGTH	GRID WIDTH	OVERALL WIDTH	N2A-XX-S014N-350	350 $\pm 0.2\%$	N	E2
0.125	0.545	0.060	0.189				
3.18	13.84	1.52	4.80				
MATRIX SIZE	0.62 L x 0.26 W		15.8 L x 6.6 W				

Note 1: All products are RoHS compliant.

Transducer-Class® Strain Gages

GAGE PATTERN	Actual size shown. Enlarged when necessary for definition.	GAGE DESIGNATION See Note 1	RES. IN OHMS	STANDARD CREEP CODE	ENCAPSU- LATION OPTION AVAILABLE
	DIMENSIONS				

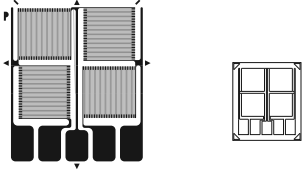
				Full-bridge pattern for single-surface gaging of transducers.				
GAGE LENGTH	OVERALL LENGTH	GRID WIDTH	OVERALL WIDTH					
0.100	0.345	0.120	0.295					
2.54	8.76	3.05	7.49					
MATRIX SIZE	0.41 L x 0.36 W		10.4 L x 9.1 W		N2A-XX-S056R-350	350 ± 0.2%	R*	E2
					N2A-XX-S120P-10C	1000 ± 0.2%	P*	E2

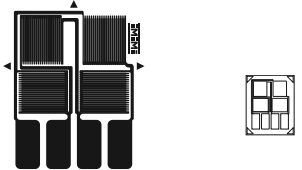
				Low-cost full-bridge gage for bending-beam transducers. †BAL is balanced to ± 0.4mV/V, but RG is 1200 ohms ± 15%.				
GAGE LENGTH	OVERALL LENGTH	GRID WIDTH	OVERALL WIDTH					
0.070	0.258	0.070	0.195					
1.78	6.55	1.78	4.95					
MATRIX SIZE	0.31 L x 0.25 W		7.9 L x 6.4 W		N2A-XX-S1449-1KB	BAL ± 0.4†	N/A	E2

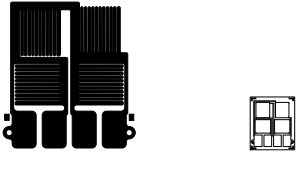
				Low-cost, full-bridge pattern for bending-beam transducers. †BAL is balanced to ± 0.4mV/V, but RG is 350 ohms ± 15%.				
GAGE LENGTH	OVERALL LENGTH	GRID WIDTH	OVERALL WIDTH					
0.070	0.238	0.070	0.190					
1.78	6.04	1.78	4.83					
MATRIX SIZE	0.27 L x 0.23 W		7.0 L x 5.8 W		N2A-XX-S1612-35B	BAL ± 0.4†	N/A	E2

*Only creep code available for this gage type.

Note 1: All products are RoHS compliant.

Diaphragm Patterns - Circular

Transducer-Class® Strain Gages

GAGE PATTERN	Actual size shown. Enlarged when necessary for definition.	GAGE DESIGNATION See Note 1	RES. IN OHMS	STANDARD CREEP CODE	ENCAPSU- LATION OPTION AVAILABLE
	DIMENSIONS				

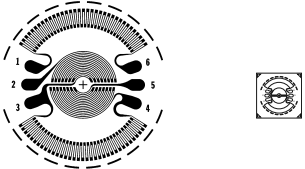
				Similar to a 182JB/JC pattern.			
PATTERN DIAMETER	CIRCULAR TRIM DIAMETER†	MIN. DIAPHRAGM DIAMETER	MATRIX SIZE- (SQUARE)				
0.182	0.200	0.210	0.23				
4.62	5.08	5.3	5.8				
MATRIX SIZE	0.23 L x 0.23 W		5.8 L x 5.8 W				
				EA-XX-S067F-350 N2A-XX-S067F-350	350 ± 1.0% 350 ± 1.0%	F* F*	E3

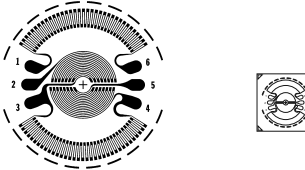
				Similar to a 228JB/JC pattern.			
PATTERN DIAMETER	CIRCULAR TRIM DIAMETER†	MIN. DIAPHRAGM DIAMETER	MATRIX SIZE- (SQUARE)				
0.228	0.250	0.260	0.30				
5.79	6.35	6.6	7.6				
MATRIX SIZE	0.30 L x 0.30 W		7.6 L x 7.6 W				
				EA-XX-S102H-350 N2A-XX-S102H-350 N2K-XX-S066H-350/DP TK-XX-S066H-350/DP SK-XX-S066H-350	350 ± 1.0% 350 ± 1.0% 350 ± 1.0% 350 ± 1.0% 350 ± 2.0%	H* H* H* H* H*	E2 E2 E2

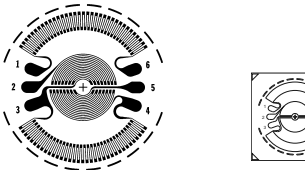
				Similar to a 364JB/JC pattern.			
PATTERN DIAMETER	CIRCULAR TRIM DIAMETER†	MIN. DIAPHRAGM DIAMETER	MATRIX SIZE- (SQUARE)				
0.364	0.400	0.410	0.46				
9.25	10.16	10.4	11.7				
MATRIX SIZE	0.46 L x 0.46 W		11.7 L x 11.7 W				
				EA-XX-S050P-350 N2A-XX-S050P-350 N2K-XX-S060P-350/DP TK-XX-S060P-350/DP SK-XX-S060P-350	350 ± 0.5% 350 ± 0.5% 350 ± 0.5% 350 ± 0.5% 350 ± 0.5%	P* P* P* P* P*	E2 E2 E2 E2

*Only creep code available for this gage type.

Transducer-Class® Strain Gages

Note 1: Products shown in bold are not RoHS compliant.

GAGE PATTERN	Actual size shown. Enlarged when necessary for definition.	GAGE DESIGNATION See Note 1	RES. IN OHMS	STANDARD CREEP CODE	ENCAPSU- LATION OPTION AVAILABLE
	DIMENSIONS				

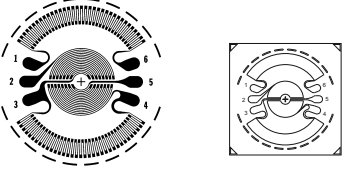
				Similar to a 455JB/JC pattern.			
				PATTERN DIAMETER	CIRCULAR TRIM DIAMETER†	MIN. DIAPHRAGM DIAMETER	MATRIX SIZE- (SQUARE)
0.455	0.500	0.510	0.58	EA-XX-S046R-350	350 ± 0.5%	R*	E2
11.56	12.70	13.0	14.7	EA-XX-S070R-10C	1000 ± 0.5%	R*	E2
				N2A-XX-S046R-350	350 ± 0.5%	R*	E2
				N2A-XX-S070R-10C	1000 ± 0.5%	R*	E2
				N2K-XX-S073R-350/DP	350 ± 0.5%	R*	E2
				TK-XX-S073R-350/DP	350 ± 0.5%	R*	E2
MATRIX SIZE	0.58 L x 0.58 W		14.7 L x 14.7 W	SK-XX-S073R-350	350 ± 1.0%	R*	

†Option SP70, factory trimmed to this dimension ± 0.005 in (0.13mm) is available on the EA-, N2A-, and N2K-Series diaphragm gages.

*Only creep code available for this gage type.

Note 1: Products shown in bold are not RoHS compliant.

Diaphragm Patterns - Linear

Transducer-Class® Strain Gages

GAGE PATTERN	Actual size shown. Enlarged when necessary for definition.		GAGE DESIGNATION See Note 1	RES. IN OHMS	STANDARD CREEP CODE	ENCAPSULATION OPTION AVAILABLE
	DIMENSIONS	<input type="checkbox"/> inch <input type="checkbox"/> millimeter				

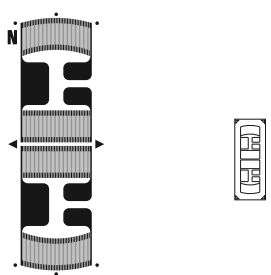
				Full-bridge pattern for use on 0.375 in (9.6mm) diameter diaphragm.			
GAGE LENGTH	OVERALL LENGTH	GRID WIDTH	OVERALL WIDTH				
0.030	0.355	0.100	0.100	N2A-XX-S094N-350	350 ± 0.3%	N*	
				N2K-XX-S097N-10C/DP	1000 ± 0.3%	N*	
				N2K-XX-S095N-35C/DP	3500 ± 0.3%	N*	
				TK-XX-S097N-10C/DP	1000 ± 0.3%	N*	
				TK-XX-S095N-35C/DP	3500 ± 0.3%	N*	
MATRIX SIZE	0.42 L x 0.16 W		10.8 L x 4.1 W				

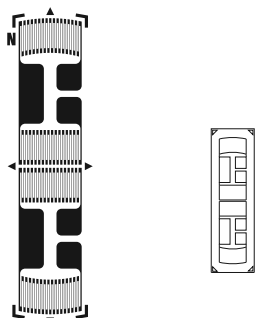
				Full-bridge pattern for use on 0.5 in (12.7mm) diameter diaphragm.			
GAGE LENGTH	OVERALL LENGTH	GRID WIDTH	OVERALL WIDTH				
0.040	0.470	0.100	0.100	EA-XX-S084N-350	350 ± 0.3%	N*	
				N2A-XX-S084N-350	350 ± 0.3%	N*	
				N2A-XX-S147N-10C	1000 ± 0.3%	N*	
				N2K-XX-S092N-350/DP	350 ± 0.3%	N*	
				N2K-XX-S171N-10C/DP	1000 ± 0.3%	N*	
				N2K-XX-S093N-35C/DP	3500 ± 0.3%	N*	
				TK-XX-S092N-350/DP	350 ± 0.3%	N*	
				TK-XX-S171N-10C/DP	1000 ± 0.3%	N*	
				TK-XX-S093N-35C/DP	3500 ± 0.3%	N*	
MATRIX SIZE	0.54 L x 0.16 W		13.7 L x 4.1 W				

*Only creep code available for this gage type.

Note 1: All products are RoHS compliant.

Transducer-Class® Strain Gages

GAGE PATTERN	Actual size shown. Enlarged when necessary for definition.	GAGE DESIGNATION See Note 1	RES. IN OHMS	STANDARD CREEP CODE	ENCAPSU- LATION OPTION AVAILABLE
	DIMENSIONS				

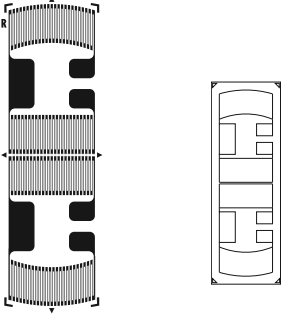
				Full-bridge pattern for use on 0.75 in (19.1mm) diameter diaphragm.							
GAGE LENGTH	OVERALL LENGTH	GRID WIDTH	OVERALL WIDTH	EA-XX-S079R-350 N2A-XX-S079R-350		350 ± 0.3% 350 ± 0.3%		R* R*		E2 E2	
0.070	0.700	0.200	0.200								
1.78	17.78	5.08	5.08								
MATRIX SIZE	0.76 L x 0.26 W		19.3 L x 6.6 W								

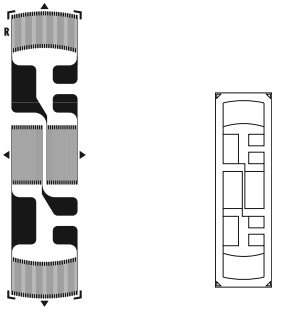
				Modified S079R. †Inner gage length 0.125 in (3.18mm) ‡Inner gage width 0.075 in (1.905mm)							
GAGE LENGTH	OVERALL LENGTH	GRID WIDTH	OVERALL WIDTH	N2A-XX-S208R-10C		1000 ± 0.3%		R*		E2	
0.070†	0.700	0.160‡	0.160								
1.78	17.78	4.06	4.06								
MATRIX SIZE	0.76 L x 0.22 W		19.3 L x 5.6 W								

*Only creep code available for this gage type.

Note 1: All products are RoHS compliant.

Diaphragm Patterns - Linear

Transducer-Class® Strain Gages

GAGE PATTERN	Actual size shown. Enlarged when necessary for definition.		GAGE DESIGNATION See Note 1	RES. IN OHMS	STANDARD CREEP CODE	ENCAPSULATION OPTION AVAILABLE
	DIMENSIONS	<input type="checkbox"/> inch <input type="checkbox"/> millimeter				

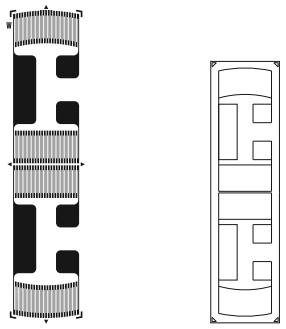
				Full-bridge pattern for use on 1.0 in (25.4mm) diameter diaphragm.				
GAGE LENGTH	OVERALL LENGTH	GRID WIDTH	OVERALL WIDTH					
0.070	0.940	0.200	0.200					
1.78	23.88	5.08	5.08					
MATRIX SIZE	0.99 L x 0.26 W		25.2 L x 6.6 W		N2A-XX-S062W-350	350 ± 0.3%	W*	E2

*Only creep code available for this gage type.

Note 1: All products are RoHS compliant.

Transducer-Class® Strain Gages

GAGE PATTERN	Actual size shown. Enlarged when necessary for definition.	GAGE DESIGNATION See Note 1	RES. IN OHMS	STANDARD CREEP CODE	ENCAPSULATION OPTION AVAILABLE
	DIMENSIONS				

				Miniature linear pattern.			
GAGE LENGTH	OVERALL LENGTH	GRID WIDTH	OVERALL WIDTH	J5E-NC-S4218-350/S RE-NC-S4218-350	350 ± 0.5% 350 ± 0.5%	N/A N/A	E2
0.032	0.160	0.062	0.062				
0.81	4.06	1.57	1.57				
MATRIX SIZE	0.20 L x 0.11 W		5.1 L x 2.8 W				

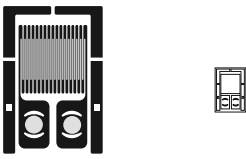
				Popular linear pattern.			
GAGE LENGTH	OVERALL LENGTH	GRID WIDTH	OVERALL WIDTH	J5E-NC-S4219-350/S RE-NC-S4219-350	350 ± 0.5% 350 ± 0.5%	N/A N/A	E2
0.060	0.180	0.100	0.100				
1.52	4.57	2.54	2.54				
MATRIX SIZE	0.23 L x 0.16 W		5.8 L x 4.1 W				

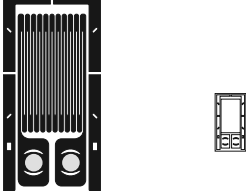
				General-purpose linear pattern.			
GAGE LENGTH	OVERALL LENGTH	GRID WIDTH	OVERALL WIDTH	J5E-NC-S4220-350/S RE-NC-S4220-350	350 ± 0.5% 350 ± 0.5%	N/A N/A	E2
0.125	0.255	0.100	0.100				
3.18	6.48	2.54	2.54				
MATRIX SIZE	0.30 L x 0.16 W		7.6 L x 4.1 W				

Note 1: All products are RoHS compliant.

Transducer-Class® Strain Gages

GAGE PATTERN	Actual size shown. Enlarged when necessary for definition.		GAGE DESIGNATION See Note 1	RES. IN OHMS	STANDARD CREEP CODE	ENCAPSULATION OPTION AVAILABLE
	DIMENSIONS	<div style="display: flex; justify-content: space-around;"> inch millimeter </div>				

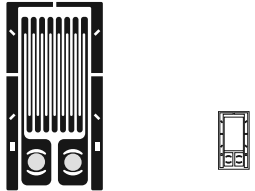
				175-ohm version of S4220 pattern.				
GAGE LENGTH	OVERALL LENGTH	GRID WIDTH	OVERALL WIDTH					
0.125	0.255	0.100	0.100					
3.18	6.48	2.54	2.54					
MATRIX SIZE	0.30 L x 0.16 W		7.6 L x 4.1 W		J5E-NC-S4221-175/S	175 ± 0.5%	N/A	E2
					RE-NC-S4221-175	175 ± 0.5%	N/A	

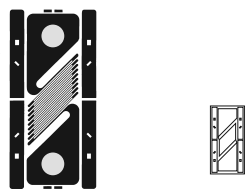
				Compact "left hand" single shear gage.				
GAGE LENGTH	OVERALL LENGTH	GRID WIDTH	OVERALL WIDTH					
0.100	0.324	0.060	0.098					
2.54	8.23	1.52	2.48					
MATRIX SIZE	0.35 L x 0.18 W		8.9 L x 4.6 W		J5E-NC-S4215-350/S	350 ± 0.5%	N/A	E2
					RE-NC-S4215-350	350 ± 0.5%	N/A	

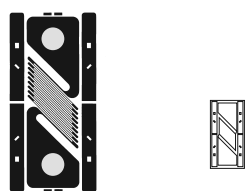
				Compact "right hand" single shear gage.				
GAGE LENGTH	OVERALL LENGTH	GRID WIDTH	OVERALL WIDTH					
0.100	0.324	0.060	0.098					
2.54	8.23	1.52	2.48					
MATRIX SIZE	0.35 L x 0.18 W		8.9 L x 4.6 W		J5E-NC-S4216-350/S	350 ± 0.5%	N/A	E2
					RE-NC-S4216-350	350 ± 0.5%	N/A	

Note 1: All products are RoHS compliant.

Transducer-Class® Strain Gages

GAGE PATTERN	Actual size shown. Enlarged when necessary for definition.	GAGE DESIGNATION See Note 1	RES. IN OHMS	STANDARD CREEP CODE	ENCAPSULATION OPTION AVAILABLE
	DIMENSIONS				

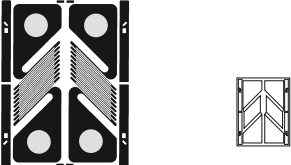
				Dual element shear gage.				
GAGE LENGTH	OVERALL LENGTH	GRID WIDTH	OVERALL WIDTH					
0.100 ES	0.324	0.060 ES	0.212					
2.54 ES	8.23	1.52 ES	5.38					
MATRIX SIZE	0.36 L x 0.28 W		8.9 L x 7.1 W		J5E-NC-S4217-350/S RE-NC-S4217-350	350 ± 0.8% 350 ± 0.8%	N/A N/A	E2

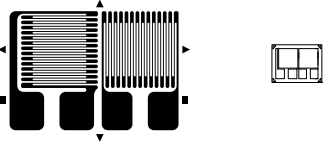
				General-purpose tee rosette in platinum-tungsten alloy.				
GAGE LENGTH	OVERALL LENGTH	GRID WIDTH	OVERALL WIDTH					
0.070	0.155	0.100	0.220					
1.78	3.94	2.54	5.59					
MATRIX SIZE	0.19 L x 0.26 W		4.8 L x 6.6 W		J5E-NC-S4225-350/S RE-NC-S4225-350	350 ± 0.8% 350 ± 0.8%	N/A N/A	E2

Note 1: All products are RoHS compliant.

Introduction and Designation System

Micro-Measurements manufactures a variety of fixed, adjustable, and combination bondable resistors for use in many applications where precise resistance is required. Appropriate patterns are available in both low and high temperature-coefficient-of-resistance types. Widest use is in transducer bridge circuits to compensate for small temperature-induced errors and to adjust bridge-balance output.¹ Figure 1 (on the facing page) shows a typical application.

Various foil types, sizes, and patterns are available, allowing selection of the optimum resistor for specific applications. Resistors are normally produced open-faced on the flexible E or N2 polyimide backings. The recommended temperature range is 0° to +350°F [-20° to +175°C] for the E type and 0° to +300°F [-20° to +150°C] for the N2. Standard packaging for bondable resistors is 50 per package.

TEMPERATURE-COMPENSATED RESISTORS

Temperature-compensated A alloy and K alloy are available in several resistor patterns. They are normally stocked in both 06 S-T-C for steel and 13 S-T-C for aluminum. Due to the difficulty of directly soldering to K alloy, all N2K resistors are supplied with a copper soldering pad (DP) on each tab.

TEMPERATURE-SENSITIVE RESISTORS

Three different foil materials are available to fit a variety of compensation requirements.

Nickel — Pure nickel has the highest resistance-versus-temperature sensitivity of the three available foil types and is normally selected for span-versus-temperature compensation. It can be ordered as a fixed resistance value (A Pattern) or adjustable (B Pattern). The temperature coefficient of resistance (TCR) for nickel is +0.33%/°F [+0.59%/°C] over a temperature range of +50° to +150°F [+10° to +65°C].

Balco[®] — Although having a slightly lower TCR than nickel, Balco has a higher resistivity, which makes higher resistance values more easily obtained. It also has some price advantage over nickel. The TCR for Balco is +0.24%/°F [+0.43%/°C] over a temperature range of +50° to +150°F [+10° to +65°C].

Note: Since resistance-versus-temperature for nickel and Balco is not a linear function, values are given as chord slopes over the specified temperature range.

Copper — Pure copper has the lowest TCR of the three materials and also very low resistivity. This makes it ideal for minor adjustments when used in a corner compensation approach (see Fig. 1). Copper also has a more linear TCR than either Balco or nickel. When used for span-versus-temperature correction, copper can produce a more

linear span compensation in some transducer designs. Copper TCR is +0.22%/°F [+0.40%/°C].

RESISTANCE TOLERANCES

A-Pattern resistors have fixed values (selected by the user) and are supplied with tight tolerances. With adjustable types, it is impractical to supply precise values. Most resistors will be within $\pm 20\%$ of the specified nominal values, but occasionally resistances will fall outside that range. The various cutting steps will follow the same trend.

RECOMMENDED ADHESIVES

M-Bond 610, M-Bond 43-B or M-Bond 450 adhesive should be used for operation over the widest temperature range. Other standard strain gage adhesives are acceptable within their recommended temperature limits. The special backing treatment used permits good bond formation with all strain gage adhesives except the solvent-evaporation-setting type. Resistors should be mounted in areas of low strain (preferably less than 500 $\mu\epsilon$) and on relatively flat surfaces. If possible, grids should be aligned with the direction of lowest strain.

INSTALLATION AND WIRING

All resistor patterns should be bonded to the mounting surface before adjustment or use. Prepare the specimen surface and install the resistor using standard strain gage materials and techniques. Install leadwires, and solder to the attachment tabs with an appropriate solder.

After thorough flux removal, blot with clean sponges, and allow the surface of the resistor to dry completely. Attach leadwires to an appropriate resistance-measuring instrument and adjust the resistor as described in "Adjustment Instructions" until the desired resistance is achieved.

PROTECTIVE COATINGS

For maximum long-term stability, coat the adjusted resistors with a hard, heat-curing material such as Micro-Measurements M-Bond 610, 43-B, or 450. Satisfactory results may be obtained with appropriate air-drying coatings.

¹ "Strain Gage Based Transducers — Their Design and Construction." Available from Micro-Measurements
Balco is a registered trademark of W.B. Driver Company.

Introduction and Designation System

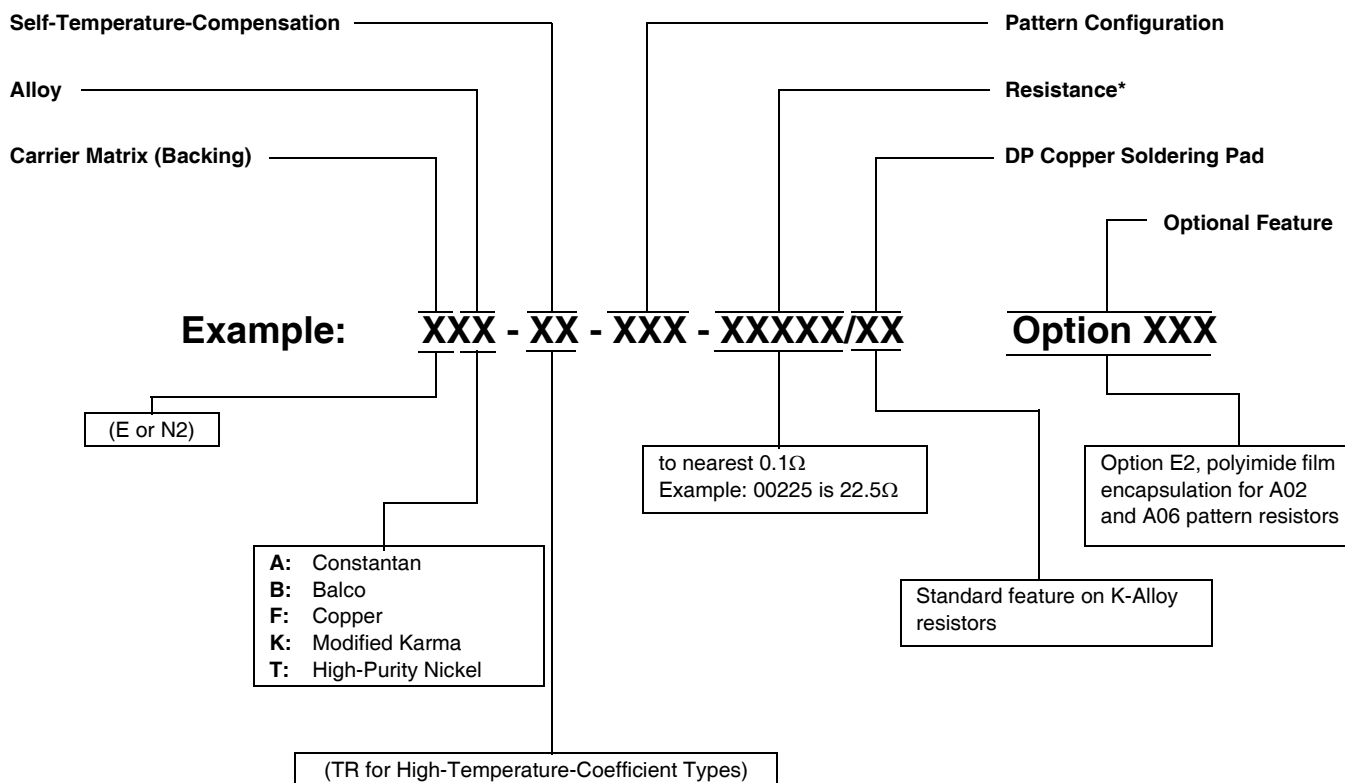





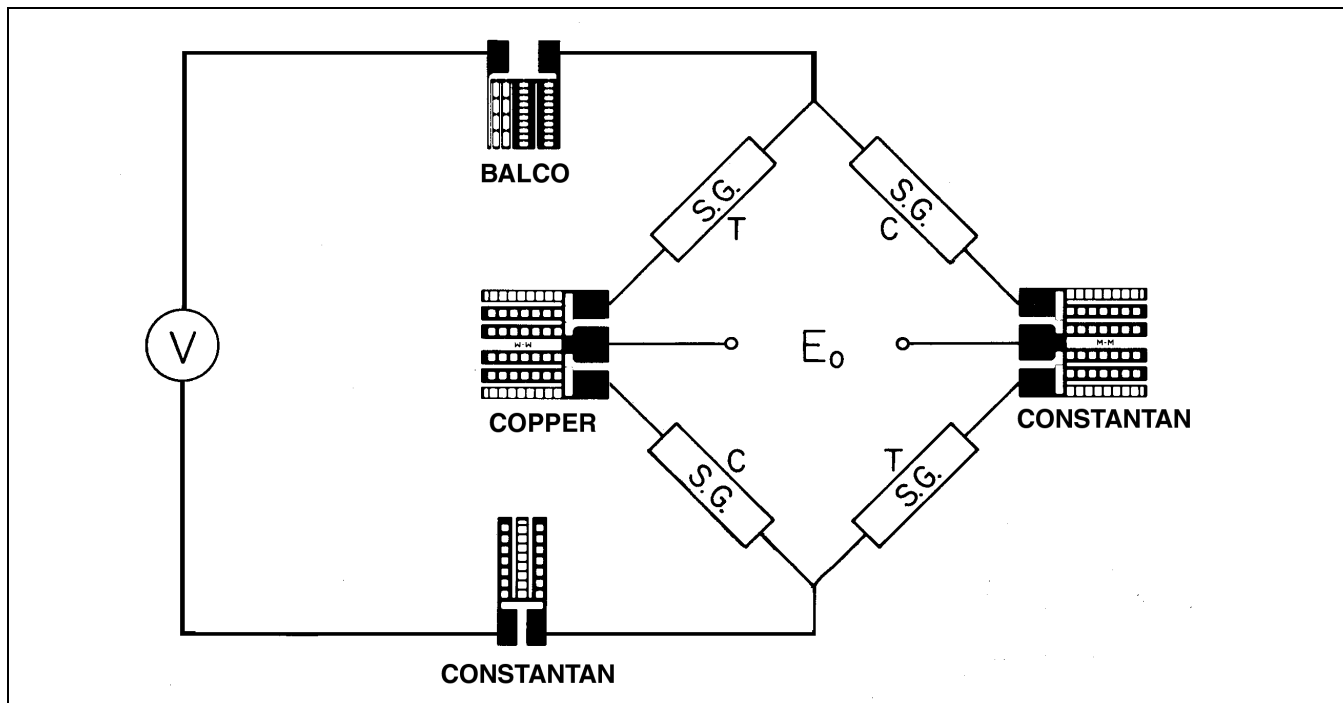

*Note: It is impossible to guarantee initial or final resistance on adjustable resistor types. Most resistors will be within $\pm 20\%$ of the nominal values given.

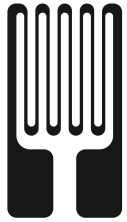
FIG. 1 BRIDGE CIRCUIT WITH TYPICAL COMPENSATION RESISTORS.

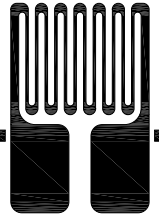



Bondable Resistors for Transducers - Selection Chart

GAGE PATTERN AND DESIGNATION Actual size shown on right Insert Desired S-T-C No. in Spaces Marked XX. See Note 1	RESISTANCE IN OHMS	DIMENSIONS				
		PATTERN		MATRIX		
		Length	Width	Length	Width	
A02		A02				
N2B-TR-A02-00150 N2B-TR-A02-00175 N2B-TR-A02-00200 N2B-TR-A02-00250 N2B-TR-A02-00300 N2B-TR-A02-00400 N2B-TR-A02-00600 N2B-TR-A02-00650 N2B-TR-A02-00700 N2T-TR-A02-00100 N2T-TR-A02-00125 N2T-TR-A02-00150 N2T-TR-A02-00200 N2T-TR-A02-00225 N2T-TR-A02-00300 N2T-TR-A02-00400 N2T-TR-A02-00450 N2T-TR-A02-00500	 	15	0.24	0.13	0.30	0.19
		17.5	6.1	3.3	7.6	4.8
		20	A06			
		25	0.19	0.13	0.24	0.18
		30	4.8	3.3	6.1	4.6
		40	<p>A Pattern fixed resistors are available in two sizes and several standard resistance values as shown. Custom resistance values are available for a small set-up charge and 500-piece minimum order.</p> <p>Resistance tolerance is $\pm 1\%$ at $+75^{\circ}\text{F}$ [$+24^{\circ}\text{C}$].</p> <p>Recommended Uses:</p> <ul style="list-style-type: none"> span-shift-versus-temperature compensation temperature sensing <p>Construction</p> <p>A02 and A06 pattern resistors are normally manufactured and stocked in unencapsulated form but can be supplied with a thin layer of polyimide film covering the grid. Solder tabs are left exposed for simplified lead connections. To include this feature add OPTION E2 to the resistor designation.</p> <p>Examples: N2B-TR-A06-00200/E2, N2T-TR-A02-00250/E2.</p> <p>Resistance tolerance on Option E2 versions is $\pm 1.5\%$ at $+75^{\circ}\text{F}$ [$+24^{\circ}\text{C}$].</p>			
		60				
		65				
		70				
		10				
		12.5				
		15				
		20				
		22.5				
		30				
40						
45						
50						
A06		A06				
N2B-TR-A06-00150 N2B-TR-A06-00175 N2B-TR-A06-00200 N2B-TR-A06-00250 N2B-TR-A06-00300 N2B-TR-A06-00400 N2B-TR-A06-00600 N2B-TR-A06-00650 N2B-TR-A06-00700 N2T-TR-A06-00100 N2T-TR-A06-00125 N2T-TR-A06-00150 N2T-TR-A06-00200 N2T-TR-A06-00225 N2T-TR-A06-00300 N2T-TR-A06-00400 N2T-TR-A06-00450 N2T-TR-A06-00500	 	15	0.25	0.13	0.33	0.18
		17.5	6.4	3.3	8.4	4.6
		20	<p>B Pattern resistors are bifilar adjustable types. The practical range of adjustment is from R_{MAX} to $0.15 R_{\text{MAX}}$, where R_{MAX} is nominal resistance prior to adjustment (see Resistor Adjustment Instructions).</p> <p>Recommended Uses:</p> <ul style="list-style-type: none"> span set (EA, N2A) span-shift-versus-temperature compensation (N2T) 			
		25				
		30				
		40				
		60				
		65				
		70				
		10				
		12.5				
		15				
		20				
		22.5				
		30				
40						
45						
50						
N2A-XX-B31-01250 EA-XX-B31-02500 N2A-XX-B32-01000 EA-XX-B32-02000 N2A-XX-B34-00700 EA-XX-B34-01400 N2T-TR-B32-00160 N2T-TR-B32-00300 N2T-TR-B34-00110 N2T-TR-B34-00220	 	125	0.25	0.13	0.33	0.18
		250	6.4	3.3	8.4	4.6
		100	<p>B Pattern resistors are bifilar adjustable types. The practical range of adjustment is from R_{MAX} to $0.15 R_{\text{MAX}}$, where R_{MAX} is nominal resistance prior to adjustment (see Resistor Adjustment Instructions).</p> <p>Recommended Uses:</p> <ul style="list-style-type: none"> span set (EA, N2A) span-shift-versus-temperature compensation (N2T) 			
		200				
		70				
		140				
		16				
		30				
		11				
		22				

Note 1: All products are RoHS compliant.

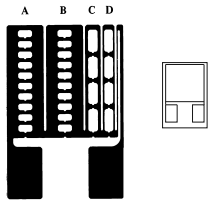
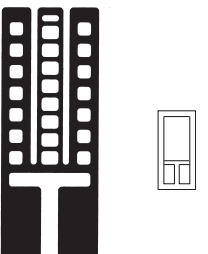
Bondable Resistors for Transducers - Selection Chart

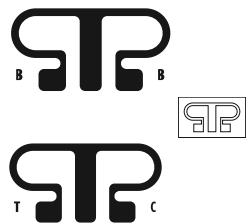
GAGE PATTERN AND DESIGNATION Actual size shown on right Insert Desired S-T-C No. in Spaces Marked XX See Note 1	RESISTANCE IN OHMS		DIMENSIONS			
			PATTERN		MATRIX	
			Length	Width	Length	Width
N2B-TR-C11-00050 N2B-TR-C12-00100 N2B-TR-C12-00200 N2B-TR-C13-00400 N2B-TR-C13-00800 	Before Cut After Cut 5 12 10 24 20 48 40 96 80 192	0.30	0.20	0.34	0.23	
		7.6	5.1	8.6	5.9	
		C Pattern grid and adjustable ladder resistors are available in various nominal resistances adjustable to 240% of the initial value. Nominal cutting steps: 4 at 20%; 4 at 10%; and 20 at 1% (see Resistor Adjustment Instructions). Recommended Uses: • span-shift-versus-temperature compensation				
		D Pattern adjustable ladder resistor is a small, single-network pattern available in various alloys and resistances (see Resistor Adjustment Instructions). Resistances listed are nominal fully cut values. Recommended Uses: • zero-shift compensation (N2F) • span-shift-versus-temperature compensation (N2B) • span set (EA, N2A, and N2K)				
		E Pattern adjustable ladder resistors are similar to the D Pattern but incorporate two adjustable networks on one matrix to provide the differential adjustment capability often required in bridge balance and zero-shift compensation (see Resistor Adjustment Instructions). Resistances listed are nominal fully cut values per network. Recommended Uses: • zero-shift compensation (N2F) • bridge balance (EA, N2A, and N2K)				
N2F-TR-D01-00005 N2B-TR-D01-00060 N2A-XX-D01-00180 EA-XX-D01-00360 N2K-XX-D01-00500/DP N2K-XX-D01-00750/DP 	0.5 6 18 36 50 75	0.35	0.14	0.41	0.20	
		8.9	3.6	10.4	5.1	
		D Pattern adjustable ladder resistor is a small, single-network pattern available in various alloys and resistances (see Resistor Adjustment Instructions). Resistances listed are nominal fully cut values. Recommended Uses: • zero-shift compensation (N2F) • span-shift-versus-temperature compensation (N2B) • span set (EA, N2A, and N2K)				
		E Pattern adjustable ladder resistors are similar to the D Pattern but incorporate two adjustable networks on one matrix to provide the differential adjustment capability often required in bridge balance and zero-shift compensation (see Resistor Adjustment Instructions). Resistances listed are nominal fully cut values per network. Recommended Uses: • zero-shift compensation (N2F) • bridge balance (EA, N2A, and N2K)				
		H Pattern resistors are adjusted upward in resistance value by rubbing the foil loops with a hand-held or electric pencil eraser. The H21 patterns, produced in constantan alloy, are used for bridge-balance adjustment. (2.5-ohm resistors are typically employed in 350-ohm bridges, and 6.0 ohm in 1000-ohm bridges.) The H22, produced in Balco alloy, is used for bridge zero-versus-temperature adjustment (see Resistor Adjustment Instructions). Resistance values are nominal. Recommended Uses: • bridge balance (H21) • bridge zero-shift compensation (H22)				
N2F-TR-E01-00005 N2A-XX-E01-00060 N2A-XX-E01-00180 EA-XX-E01-00360 N2K-XX-E01-00500/DP N2K-XX-E01-00750/DP 	0.5 6 18 36 50 75	0.35	0.30	0.41	0.36	
		8.9	7.6	10.4	9.1	
		E Pattern adjustable ladder resistors are similar to the D Pattern but incorporate two adjustable networks on one matrix to provide the differential adjustment capability often required in bridge balance and zero-shift compensation (see Resistor Adjustment Instructions). Resistances listed are nominal fully cut values per network. Recommended Uses: • zero-shift compensation (N2F) • bridge balance (EA, N2A, and N2K)				
		H Pattern resistors are adjusted upward in resistance value by rubbing the foil loops with a hand-held or electric pencil eraser. The H21 patterns, produced in constantan alloy, are used for bridge-balance adjustment. (2.5-ohm resistors are typically employed in 350-ohm bridges, and 6.0 ohm in 1000-ohm bridges.) The H22, produced in Balco alloy, is used for bridge zero-versus-temperature adjustment (see Resistor Adjustment Instructions). Resistance values are nominal. Recommended Uses: • bridge balance (H21) • bridge zero-shift compensation (H22)				
		H Pattern resistors are adjusted upward in resistance value by rubbing the foil loops with a hand-held or electric pencil eraser. The H21 patterns, produced in constantan alloy, are used for bridge-balance adjustment. (2.5-ohm resistors are typically employed in 350-ohm bridges, and 6.0 ohm in 1000-ohm bridges.) The H22, produced in Balco alloy, is used for bridge zero-versus-temperature adjustment (see Resistor Adjustment Instructions). Resistance values are nominal. Recommended Uses: • bridge balance (H21) • bridge zero-shift compensation (H22)				
N2A-XX-H21-00025 N2A-XX-H21-00060 N2B-TR-H22-00010 	2.5 6.0 1.0	0.15	0.29	0.21	3.5	
		3.8	7.4	5.3	8.9	
		H Pattern resistors are adjusted upward in resistance value by rubbing the foil loops with a hand-held or electric pencil eraser. The H21 patterns, produced in constantan alloy, are used for bridge-balance adjustment. (2.5-ohm resistors are typically employed in 350-ohm bridges, and 6.0 ohm in 1000-ohm bridges.) The H22, produced in Balco alloy, is used for bridge zero-versus-temperature adjustment (see Resistor Adjustment Instructions). Resistance values are nominal. Recommended Uses: • bridge balance (H21) • bridge zero-shift compensation (H22)				
		H Pattern resistors are adjusted upward in resistance value by rubbing the foil loops with a hand-held or electric pencil eraser. The H21 patterns, produced in constantan alloy, are used for bridge-balance adjustment. (2.5-ohm resistors are typically employed in 350-ohm bridges, and 6.0 ohm in 1000-ohm bridges.) The H22, produced in Balco alloy, is used for bridge zero-versus-temperature adjustment (see Resistor Adjustment Instructions). Resistance values are nominal. Recommended Uses: • bridge balance (H21) • bridge zero-shift compensation (H22)				
		H Pattern resistors are adjusted upward in resistance value by rubbing the foil loops with a hand-held or electric pencil eraser. The H21 patterns, produced in constantan alloy, are used for bridge-balance adjustment. (2.5-ohm resistors are typically employed in 350-ohm bridges, and 6.0 ohm in 1000-ohm bridges.) The H22, produced in Balco alloy, is used for bridge zero-versus-temperature adjustment (see Resistor Adjustment Instructions). Resistance values are nominal. Recommended Uses: • bridge balance (H21) • bridge zero-shift compensation (H22)				

RESISTANCE WIRE

While wire does not track the temperature of the strain gages as closely as bondable resistors, there are instances where bondable resistors cannot be used due to limited mounting space. Micro-Measurements stocks two types of resistance wire alloys.

CATALOG NO./ WIRE ALLOY	QTY PER SPOOL	RESISTANCE PER FOOT (METER) NOMINAL	TCR [-10° to +50°C]	INSULATION	TEMPERATURE RANGE
137-HWN/Manganin	200ft [61m]	14Ω (46Ω)	± 0.0011%/°F [± 0.002%/°C]	Enamel	+15° to +120°F [-10° to +50°C] (up to +175°F [+80°C] if proper aging is done)
142-JWN/Balco	500ft [152 m]	19Ω (62Ω)	+0.25%/°F [+0.45%/°C]	Enamel	-15° to +300°F [-10° to +150°C]

Note 1: All products are RoHS compliant.

Bondable Resistors for Transducers

B PATTERN

The B Pattern bondable resistor is adjusted (decrease in resistance) by shorting out the parallel conducting lines at a desired point along their length. Depending on required stability, shorting can be accomplished through use of a suitable solder or a conductive silver compound.

RECOMMENDED ADJUSTMENT MATERIALS

Solders

63-36.65-0.35 tin-lead-antimony (MM Part No. 361A-20R). Maximum service temperature is +300°F (+150°C).

Conductive Silver (Air-Drying)

#FH-1629 (Acheson Colloids Company)

#8030 (DuPont Electrochemicals Department)

C, D, AND E PATTERNS

Patterns C, D, and E resistors are adjusted (increase in resistance) by cutting various foil bars.

Using an appropriate degree of magnification (preferably under a stereoscopic zoom microscope), locate the cutting points on the resistor pattern. Cuts may be made with the tip of a scalpel blade, or with a tool made by slightly flattening the end of a dental probe (MM Part No. DPR-1). Lightly cut through each end of the shorting bar and lift out the center section, leaving a path clear of foil. Care must be taken to avoid cutting through the backing to the specimen.

The approximate cuts to produce a desired overall pattern resistance can be estimated from the following information for the appropriate pattern; however, many variations may be employed and experimentation may be required to determine the optimum cutting sequence. For example: If steps are cut progressively downward starting from the top of any ladder (for all above patterns), very small changes in resistance are produced. Cuts made in this manner will represent larger changes as the step nearest the large solder tabs is approached.

Note that the actual resistance increase caused by cutting any given step can vary up to 20% of the nominal value. Therefore, it is desirable to plan a series of cuts that will allow the final resistance value to be approached slowly enough to avoid overadjustment. Fine adjustment can also be achieved by gently polishing active portions of the network with 325-mesh alumina powder. This procedure is not recommended when maximum stability is required, however.

C Pattern

The resistance changes produced by cutting the various adjustment steps are specified in terms of R_{MIN} , the uncut pattern resistance. The tabulated data are typical, and were obtained by cutting progressively upward starting with the step nearest the soldering tabs in each respective ladder.

NOTE: Although there are several variations of the C Pattern, the same respective 28 adjusting steps are available in each.

LADDER	APPROX. ΔR AS % R_{MIN}
A	1
B	1
C	10
D	20

D AND E PATTERNS

The resistance values listed for these patterns are the maximum obtainable - after cutting all the ladder steps except the top rung of each row. For the E Pattern, the resistance is measured between terminals 1 and 2, or 2 and 3, with the corresponding shunt (G) cut.

Referring to the pattern diagram for the D resistor, when cutting progressively upward on the center ladder, each step will correspond roughly to an increment of 5.6% of R_{MAX} . The outside ladders provide finer adjustment with each upward step, about 3.4% R_{MAX} .

The shunt (G) in each network of the E Pattern reduces uncut resistance approximately 25%, and reduces adjustment increments of ladders A, B, E and F about 50% to increase resolution. With the shunts uncut, the resistance changes produced by cutting each upward step of ladders A through F as a percentage of R_{MAX} are approximately 2.8%, 1.7%, 3.4%, 3.4%, 1.7% and 2.8%, respectively. R_{MIN} for these patterns is about 0.08 R_{MAX} .

With the shunts (G) cut, the E Pattern is essentially two D resistors with a common solder tab.

H21 AND H22 PATTERNS

H21

The H21 resistor is designed to be wired into a corner of the Wheatstone bridge like the Constantan E01 pattern shown in Figure 1 in Bondable Resistors for Transducers. Resistance adjustment for zero balance is accomplished by rubbing the appropriate loop of the H21 with a soft pencil eraser. An electric eraser can be used to speed the process.

H22

The H22 resistor is similar in application and adjustment to the H21 except its use is for zero-shift-versus-temperature compensation. Setting the H22 resistance value is readily accomplished by calculating its adjustment influence on bridge zero balance after conducting zero-versus-temperature testing of the completed transducer.

Resistance calculation formulas are available upon request.



M-Line Accessories For Transducer Applications

Surface Cleaning Supplies	42
M-Bond 610.....	44
M-Bond 43-B for Transducers	45
M-Bond 450.....	46
Installation Tools	47
Bondable Terminals	50
Solders and Accessories.....	52
Wire, Cable and Accessories	54
M-Coat A	56
M-Coat B	57
M-Coat C	58
M-Coat D	59
M-Coat FBT.....	60
M-Coat W-1	61
3140 RTV	62
3145 RTV	63
TAK-610 Kit.....	64
TransCalc™ Software	65

Selection Guide for Transducer Applications



MATERIALS LIST

- Solvent Cleaners
- Water-Based Cleaners
- Surface-Abrasion Materials
- Special-Purpose Materials



RoHS
COMPLIANT

For proper bonding of strain gages and compensation resistors, the surface of the transducer must be chemically clean and totally free of contaminants before applying the adhesive. Instruction Bulletin B-130 lists applicable cleaning materials and techniques for the use of M-Bond 610 and

43-B adhesives. For surface cleaning in “production-line” transducer manufacturing, refer to alternate cleaning procedures outlined in Micro-Measurements publication Strain Gage Installation Procedures for Transducers, a copy of which is available upon request.

SOLVENT CLEANERS

CSM-2:

Degreaser: A powerful environmentally friendly degreaser. Readily attacks general-purpose lubricating and hydraulic oils. Non-flammable. 22oz (0.62kg) pressured spray can. Dispensing solvents from “one way” containers prevents contamination buildup.

GC-6:

Isopropyl Alcohol: Frequently used as a solvent degreaser where other solutions are restricted. Flammable. 4oz (120ml) bottle.

WATER-BASED CLEANERS

Conditioner A:

A mild phosphoric acid compound. Acts as a mild etchant and accelerates the cleaning process.

MCA-1: 2oz (60ml) plastic squeeze bottle with on/off dispenser nozzle cap.

MCA-2: Same as MCA-1 except 16oz (0.5l).

Neutralizer 5A:

An ammonia-based material. Neutralizes any chemical reaction introduced by Conditioner A, and produces optimum surface conditions for most strain gage adhesives.

MN5A-1: 2oz* [60ml] plastic squeeze bottle with on/off dispenser nozzle bottle cap.

MN5A-2: Same as MN5A-1 except 16oz (0.5l).

*Note: The 2oz [60ml] size is recommended for bench use and is easily refilled from the 16oz [0.5l] bottle.

Selection Guide for Transducer Applications

SURFACE-ABRASION MATERIALS

Abrading is often necessary to dislodge contaminants and to remove rust, scale, etc. When grit-blasting, use fine alumina powder and high-quality filters, and never recycle used grit. Silicon-carbide paper may be used as an alternate to grit blasting.

Silicon-Carbide Paper:

SCP-1 220-grit: Suited to most steels. 1in x 100ft [25mm x 30m] roll.

SCP-2 320-grit: Suited to most steels. Also suited to aluminum alloys and other soft metals. 1in x 100ft [25mm x 30m] roll.

SCP-3 400-grit: Suited to aluminum alloys and other soft metals. 1in x 100ft [25mm x 30m] roll.

GC-5 Pumice Powder:

Produces a dull, matte finish. Recommended for minimal removal of surface material. 1/2oz [15ml] bottle.

SPECIAL-PURPOSE MATERIALS

CSP-1 Cotton Swabs:

100 single-ended applicators per package (6in [150mm] long, wooden stick).

GSP-1 Gauze Sponges:

200 3 x 3in [75 x 75mm] sponges per package.

Strain Gage Adhesives for Transducer Applications



OTHER ACCESSORIES USED IN AN M-BOND 610 INSTALLATION:

- CSM Degreaser or GC-6 Isopropyl Alcohol
- Silicon-Carbide Paper
- M-Prep Conditioner A
- M-Prep Neutralizer 5A
- GSP-1 Gauze Sponges
- CSP-1 Cotton Applicators
- MJG-2 Mylar® Tape
- TFE-1 Teflon® Film
- HSC Spring Clamp
- GT-14 Pressure Pads and Backup Plates



DESCRIPTION

Two-component, solvent-thinned, epoxy-phenolic adhesive for high-precision transducers; solids content 22%. Low viscosity, capable of gluelines <0.0002 in [0.005mm].

Extremely thin, hard, void-free gluelines minimize creep, hysteresis, and linearity problems. Life limited by oxidation and sublimation effects at elevated temperatures.

CHARACTERISTICS

Operating Temperature Range:

-452° to +450°F
[-269°C to +230°C]

Shelf Life:

9 months at +75°F [+24°C]; 15 months at +40°F [+5°C]

Pot Life:

6 weeks at +75°F [+24°C]; 12 weeks at +40°F [+5°C]

Clamping Pressure:

45 to 60 psi [3 to 4 bar]
50 psi [3.4 bar] optimum

Cure Requirements:

Recommended Cure: *1 hour at +350°F [+175°C]

Recommended Postcure: *2 hours at +400° to +450°F
[+205° to +230°C]

*Altered for aluminum-alloy transducers. See Strain Gage Installation Procedures for Transducers.

PACKAGING

Kit:

- 4 bottles [11g ea] Curing Agent
- 4 bottles [14g ea] Resin
- 4 brush caps for applying adhesive
- 4 disposable mixing funnels

Strain Gage Adhesives for Transducer Applications

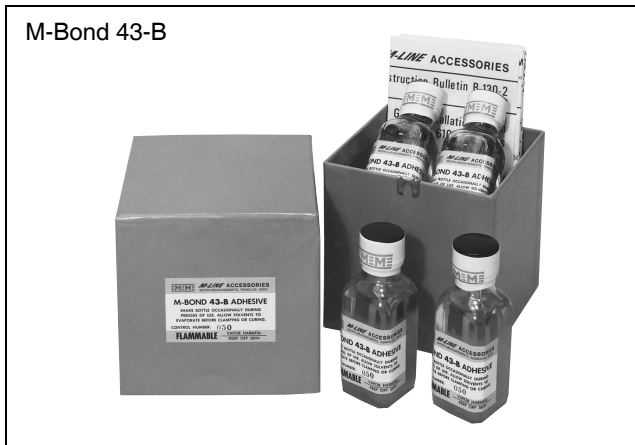

OTHER ACCESSORIES USED IN AN M-BOND 43-B INSTALLATION:

- CSM Degreaser or GC-6 Isopropyl Alcohol
- Silicon-Carbide Paper
- M-Prep Conditioner A
- M-Prep Neutralizer 5A
- GSP-1 Gauze Sponges
- CSP-1 Cotton Applicators
- MJG-2 Mylar® Tape
- TFE-1 Teflon® Film
- HSC Spring Clamp
- GT-14 Pressure Pads and Backup Plates



RoHS
COMPLIANT

DESCRIPTION

Single-component, solvent-thinned, epoxy adhesive commonly used in transducer applications; solids content 25%. May be used both as an adhesive and as a protective coating. Capable of forming very thin, hard, void-free

gluelines similar to M-Bond 610. Highly resistant to moisture and chemical attack.

CHARACTERISTICS

Operating Temperature Range:

−452° to +250°F
[−269° to +120°C]

Shelf Life:

9 months at +75°F [+24°C]
18 months at +40°F [+5°C]

Pot Life:

9 months at +75°F [+24°C]
18 months at +40°F [+5°C]

Clamping Pressure:

45 to 60 psi [3 to 4 bar]
50 psi [3.4 bar] optimum

Cure Requirements:

Recommended Cure: 2 hours at +375°F [+190°C]

Recommended Postcure: 2 hours at +400°F [+205°C]

PACKAGING

Kit:

4 brush-cap bottles (30ml ea) premixed adhesive

Strain Gage Adhesives for Transducer Applications

M-Bond 450



OTHER ACCESSORIES USED IN AN M-BOND 450 INSTALLATION:

- " CSM Degreaser or GC-6 Isopropyl Alcohol
- Silicon-Carbide Paper
- M-Prep Conditioner A
- M-Prep Neutralizer 5A
- GSP-1 Gauze Sponges
- CSP-1 Cotton Applicators
- MJG-2 Mylar® Tape
- TFE-1 Teflon® Film
- HSC Spring Clamp
- GT-14 Pressure Pads and Backup Plates



DESCRIPTION

High-performance, two-component, solvent-thinned epoxy system specially formulated for high accuracy, elevated-temperature transducer applications.

CHARACTERISTICS

Operating Temperature Range:

Short Term: -452° to +750°F (-269° to +400°C)

Long Term: -452° to +500°F (-269° to +260°C)

Shelf Life:

6 months at +75°F (+24°C)

Pot Life:

6 weeks at +75°F (+24°C)

Clamping Pressure:

60 to 100 psi (4 to 6 bar)

Cure Requirements:

Step 1: Air dry at +75°F (+24°C) 10 to 30 min

B-Stage: +225°F (+105°C) for 30 min

Cure: +350°F (+ 175°C) for 1 hour

Recommended Postcure: 1 hour at 50°F (30°C) above max operating temperature

PACKAGING

Kit:

- 4 bottles (12.5g ea) Curing Agent
- 4 bottles (12.5g ea) Resin
- 4 brush caps for applying adhesive
- 4 disposable mixing funnels

References: M-M Instruction Bulletin B-130, Strain Gage Installations with M-Bond 43-B, 600, and 610 Adhesive Systems. M-M Instruction Bulletin B-152, Instructions for the Application of Micro-Measurements M-Bond 450 Adhesive. M-M Strain Gage Accessories databook.

General Information and Selection for Transducer Applications

There is a strong element of craftsmanship involved in making consistently successful strain gage installations. As for any other field, this craft has its own special tools and working materials — found by seasoned professionals to be most effective for achieving the desired results. The installation accessories described on this and the following pages represent the distillation of many years' experience in determining the most appropriate tool or material for each task in the gage installation process.

Every accessory item listed here has been thoroughly tested and evaluated in the Micro-Measurements Applications Engineering Laboratory for quality and reliability, for ease of use, and for compatibility with all other Micro-Measurements products. It should be noted that the instruction bulletins supplied for gages, adhesives, protective coatings, etc. assume the availability of these accessories to the user, since such is generally the case for an experienced practitioner in a well-equipped laboratory.

TOOLS

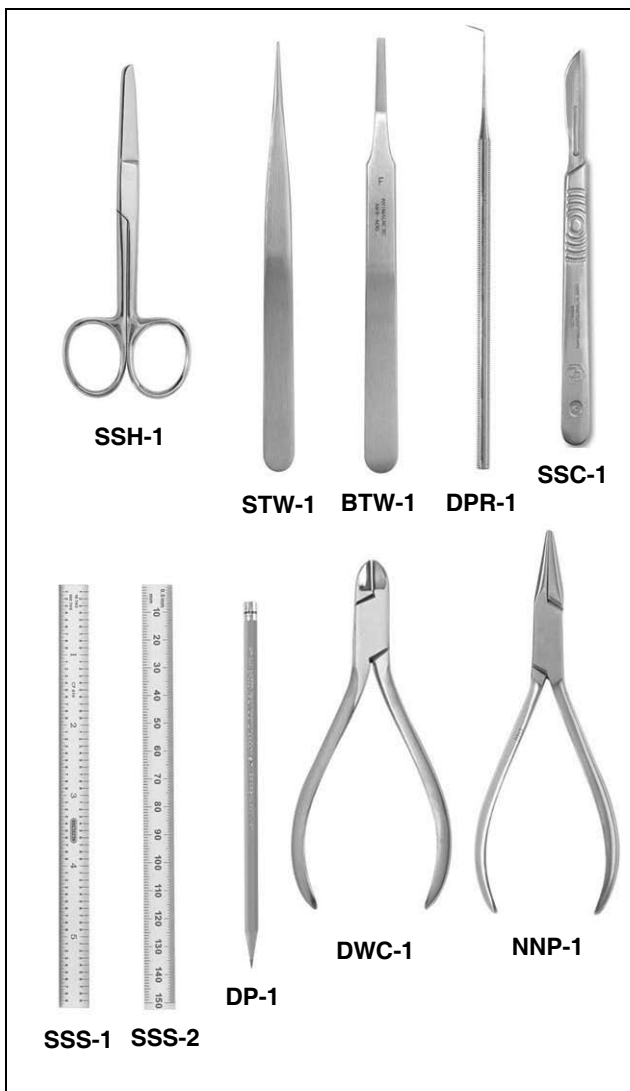

SSH-1 Surgical Shears:

Chromium steel, 4-1/2in [115mm] long, with one sharp pointed blade and one blunt-end blade.

STW-1 Tweezers:

Stainless steel, 4-1/2in [115mm] long. Rugged, precision ground sharp ends. Primarily used for handling leadwires.

BTW-1 Tweezers:

Stainless steel, 4-1/2in [115mm] long. Antimagnetic; acid and corrosion resistant. Thin, flat blunt ends ideal for safe handling of strain gages.

DPR-1 Dental Probe:

Stainless steel "pick". Flexible 75° pointed tip.

SSC-1 Surgical Scalpel and Blade:

Stainless steel, uses SSC-2 snap-in replacement blade.

SSC-2 Replacement Scalpel Blades:

Five blades per package.

SSS-1 Steel Scale:

6in [150mm] long, satin-chromed finish. Graduated in inches (1/32, 1/64, 1/10, 1/100).

SSS-2 Steel Scale:

6in [150mm] long, satin-chromed finish. Graduated in inches (1/10, 1/100) and millimeters (0.5, 1).

DP-1 4-H Drafting Pencil:

For gage layout.

DWC-1 Diagonal Cutters:

Stainless steel, 4-1/2in [115mm] long, precision cutter for wire up to AWG No. 18 [1mm diameter].

NNP-1 Needle-Nosed Pliers:

Nickel-chrome plated, 4-1/2in [115mm] long, with serrated needle-nosed jaws.

ATS-2 Gage Application Tool Set:

Includes one of each item plus one additional DPR-1 Dental Probe. Durable, polypropylene box.

General Information and Selection for Transducer Applications

TOOLS

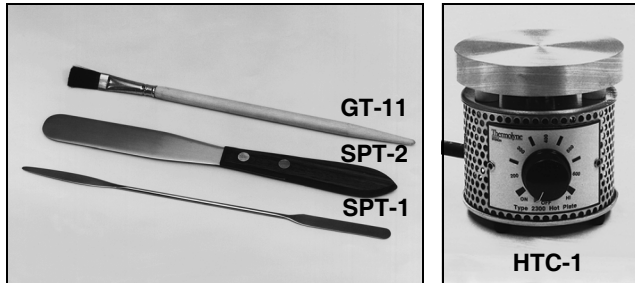

GT-11 Camel's Hair Brush:

3/8in [9.5mm].

SPT-1 Stainless Steel Mixing Spatula:

Double blade. Overall length 8in [200mm].

SPT-2 Stainless Steel Mixing Spatula:

Single blade. Overall length 7-3/4in [195mm]. Wooden handle.

HTC-1 Temperature Controlled Hotplate:

Temperature range +100° to +600°F [+40° to +315°C]. Calibrated bimetallic thermostat. 3-1/2in [90mm] diameter aluminum alloy top plate. Embedded heating elements for high thermal conductivity. 120Vac 6ft [1.8m] linecord, 3-wire plug.

WTS THERMAL WIRE STRIPPER



The ease and simplicity of operation of the Thermal Wire Stripper make it ideal for most strain gage leadwire stripping. The variable heat control allows stripping of all thermoplastic insulations, including Teflon®, in sizes No. 18 to No. 36 AWG [1 to 0.1mm diameter]. The foot switch and tweezer handpiece give excellent operator control over the stripping operation. Includes power unit and foot switch, both with 3-wire NEMA plugs, and tweezer handpiece.

WTS-1: 110Vac

WTS-2: 220Vac

WTS-A Replacement Elements

Set of two.

General Information and Selection
for Transducer Applications

HIGH-TEMPERATURE TAPES & MATERIALS

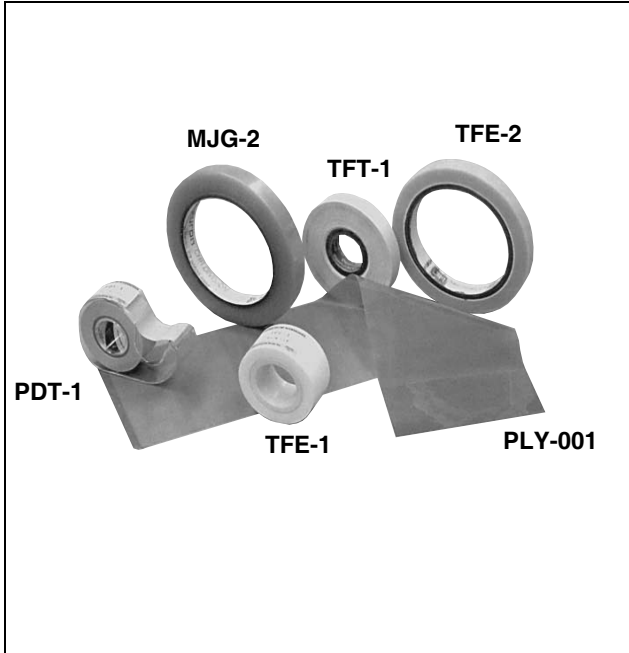

PDT-1 Paper Drafting Tape:

For soldering mask, and lead positioning. 3/4in x 400in [19mm x 10m].

PLY-001 Kapton® Film:

For electrical insulation, 4 x 10 x 0.001in thick. [100 x 250 x 0.02mm thick].

MJG-2 Mylar® Tape:

For gage handling with heat-curing resin systems. 1/2in x 216ft [13mm x 66m].

TFT-1 Thermosetting (+340°F [+170°C]) Fiberglass Tape:

For electrical insulation at high temperatures. 1/2in x 66ft [13mm x 20m].

TFE-1 Teflon Film:

0.003in x 1in x 50ft [0.08mm x 25mm x 15m].

TFE-2 High Modulus TFE Teflon® with Silicone Mastic:

1/2in x 108ft [13mm x 33m].

CLAMPING SUPPLIES

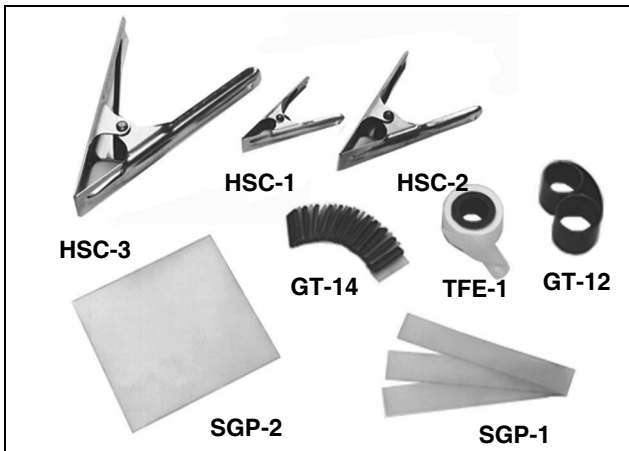

HSC-3 Spring Clamp:

Maximum Opening: 3 in [76 mm].

Maximum Recommended Opening: 1-1/2in [38mm].

Nominal Clamp Force at Recommended Opening:

25lbf [110N].

GT-12 Neg'ator Constant Force Extension Spring Clamp:

1 x 0.006 x 38in [25mm x 0.4mm x 0.97m] stainless steel band, drum I.D. 1.16in [30mm], 10.6lb [47N] load.

TFE-1 Teflon Film:

0.003in x 1in x 50ft [0.08mm x 25mm x 15m].

GT-14 Pressure Pads and Backup Plates:

Kit of 12 Silicone Rubber Pads 3/32 x 1/2 x 1-1/4in [2.5 x 13 x 32mm], and 12 aluminum plates, 1/8 x 1/2 x 1-1/4in [3 x 13 x 32mm].

SGP-1 Silicone Rubber:

Three pieces, each 3/32 x 1 x 6in [2.5 x 25 x 150mm].

SGP-2 Silicone Rubber:

One piece, 3/32 x 6 x 6in [2.5 x 150 x 150mm].

HSC-1 Spring Clamp:

Maximum Opening: 1in [25mm].

Maximum Recommended Opening: 1/2in [13mm].

Nominal Clamp Force at Recommended Opening:

30lbf [135N].

HSC-2 Spring Clamp:

Maximum Opening: 2in [51mm].

Maximum Recommended Opening: 1in [25mm].

Nominal Clamp Force at Recommended Opening:

25lbf [110N].

Mylar, Teflon, and Kapton are Registered Trademarks of DuPont.

Terminal Details and Descriptions

For many types of strain gages (such as Micro-Measurements EA-Series), instrument leadwires generally should not be attached directly to the solder tabs of the gage. Instead, the normal practice is to install bondable terminals adjacent to the gage and solder the instrument leadwires to

TERMINAL CONSTRUCTION

Micro-Measurements bondable terminals are specially designed for use in strain gage circuits. They are produced from 0.0014-in [0.036-mm] thick, copper foil, laminated on either of two types of backing material. Both backings are readily bondable with strain gage adhesives. Terminals are offered in four different geometries, and in a range of sizes to suit varying gage installation needs.

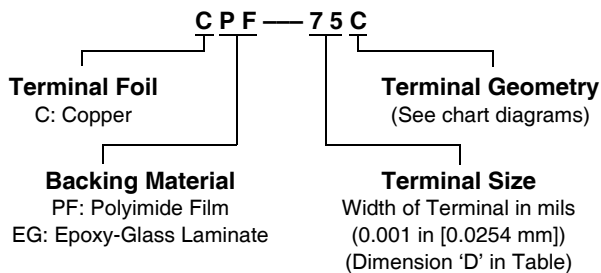

these. Small, flexible jumper wires, curved to form strain-relief loops, are then connected from the terminals to the gage solder tabs. The accompanying drawings show typical strain gage terminal installations (see also Application Note TT-603. "The Proper Use of Bondable Terminals in Strain Gage Applications").







BACKING MATERIALS

Type PF Polyimide Film:

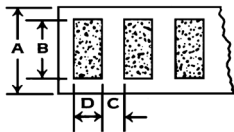
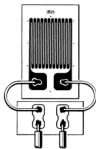



0.003 in [0.08 mm] thick. This is the preferred general-purpose backing material. It is more flexible and conformable than the Type EG, although not as strong. Type PF backing combines high-temperature capability, resistance to soldering damage and good electrical properties. It is suitable for long-term use at +450° to +500°F [+230° to +260°C], limited primarily by gradual oxidation of the copper foil interface. The relatively high thermal expansion coefficient of unfilled polyimide can cause loss of bond at temperatures below -100°F [-75°C].



Type EG Epoxy-Glass Laminate:

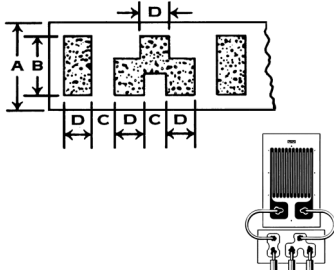

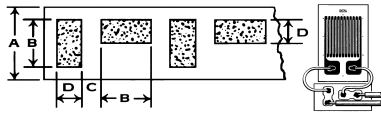

0.005 in [0.13 mm] thick. This special laminate provides a strong but flexible backing for terminals. It is suitable for long-term use at +300°F [+150°C], and is recommended for cryogenic applications at temperatures down to -452°F [-269°C]. The radius of curvature of the mounting surface should generally be greater than 1/8 in [3 mm].

Terminal Detail and Description	Terminal Pattern (Actual Size)	Dimensions (A dimensions are nominal)				Order Number	Package Strips of 4 Pairs
		A	B	C	D		
  <p>Suffix C: General-purpose. Widely used between gage jumper wires and main leadwire system. Suitable for many bridge intraconnection applications.</p>		0.11 [2.7]	0.065 [1.65]	0.025 [0.64]	0.025 [0.64]	CEG-25C CPF-25C	70
		0.14 [3.4]	0.095 [2.41]	0.030 [0.76]	0.038 [0.97]	CEG-38C CPF-38C	60
		0.18 [4.5]	0.125 [3.18]	0.036 [0.91]	0.050 [1.27]	CEG-50C CPF-50C	50
		0.25 [6.4]	0.190 [4.83]	0.040 [1.02]	0.075 [1.91]	CEG-75C CPF-75C	30
		0.33 [8.4]	0.250 [6.35]	0.070 [1.78]	0.100 [2.54]	CEG-100C CPF-100C	20
		0.48 [12.1]	0.375 [9.53]	0.070 [1.78]	0.150 [3.81]	CEG-150C CPF-150C	10

Terminal Details and Descriptions

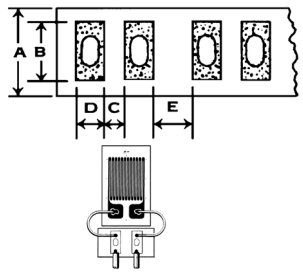
Terminal Detail and Description	Terminal Pattern (Actual Size)	Dimensions (A dimensions are nominal)				Order Number	Package Strips of 4 Pairs
		A	B	C	D		
 <p>Suffix D: Designed for installations with 2-wire jumper arrangement to gage and a 3-wire main lead system.</p>		0.18 [4.5]	0.125 [3.18]	0.036 [0.91]	0.050 [1.27]	CEG-50D CPF-50D	30
		0.21 [5.3]	0.150 [3.81]	0.038 [0.97]	0.060 [1.52]	CEG-60D CPF-60D	25
		0.25 [6.4]	0.190 [4.83]	0.040 [1.02]	0.075 [1.91]	CEG-75D CPF-75D	20
		0.33 [8.4]	0.250 [6.35]	0.050 [1.27]	0.100 [2.54]	CEG-100D CPF-100D	15

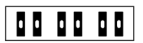
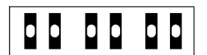
Terminal Detail and Description	Terminal Pattern (Actual Size)	Dimensions (A dimensions are nominal)				Order Number	Package Strips of 4 Pairs
		A	B	C	D		
 <p>Suffix L: Primarily used to bring main leadwires out at right angles to terminal strip.</p>		0.21 [5.3]	0.150 [3.81]	0.040 [1.02]	0.060 [1.52]	CEG-60L CPF-60L	25
		0.25 [6.4]	0.190 [4.83]	0.050 [1.27]	0.075 [1.91]	CEG-75L CPF-75L	20
	Terminal Assortment: Contains 2 strips of C, D, and L patterns, except 1 strip of the 150C and 100D designs					CEG-AST CPF-AST	22

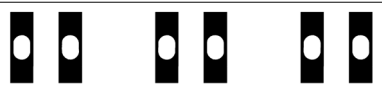
Terminal Detail and Description	Terminal Pattern (Actual Size)	Dimensions (A dimensions are nominal)					Order Number	Pkg Pairs
		A	B	C	D	E		
 <p>Suffix S: Primarily used where soldering and desoldering may be encountered. Hole in center produces thermal isolation at each end of terminal. Not recommended for high cyclic endurance. Available only in epoxy-glass backing.</p>		0.13 [3.2]	0.063 [1.60]	0.021 [0.53]	0.021 [0.53]	0.042 [1.07]	CEG-21S	200
		0.21 [5.2]	0.125 [3.18]	0.042 [1.07]	0.042 [1.07]	0.084 [2.13]	CEG-42S	100
		0.29 [7.4]	0.190 [4.83]	0.063 [1.60]	0.063 [1.60]	0.126 [3.20]	CEG-63S	100
		0.37 [9.4]	0.250 [6.35]	0.083 [2.11]	0.083 [2.11]	0.166 [4.22]	CEG-83S	60
		0.54 [13.6]	0.375 [9.53]	0.125 [3.18]	0.125 [3.18]	0.250 [6.35]	CEG-125S	30

Solders, Fluxes, Kits and Soldering Units for Transducer Applications

The quality of the solder joints is a critical element in the performance of any strain gage installation. Because of special requirements associated with strain gage circuitry, many commercial soldering stations, solders and fluxes are not satisfactory for this purpose. Micro-Measurements stocks and distributes two special soldering stations, a

selection of solders, and soldering fluxes which have been carefully tested and qualified for use with strain gages. See Micro-Measurements Strain Gage Accessories databook for additional solder types available for special applications.

SOLDERS

M-LINE strain gage solders are listed at right, along with their compositions and principal properties. For ordering purposes, the solders are specified according to the coding system shown below. All solders listed are supplied on spools.

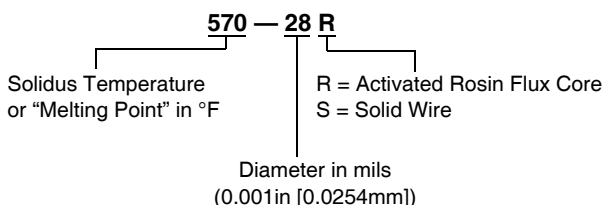

SOLDER SELECTION CHART

Solder Type (See Note 1)	Packaging		Solidus/ Liquidus Temperature	Dia.
	Order No.	Unit Size		
361A-20R 63%Tin, 36.65% Lead, 0.35% Antimony	361A-20R-25	25ft [7.6m]	361°/361°F [183°/183°C]	0.020
	361A-20R	1lb [450g]		
450-20S 95% Tin, 5% Antimony	450-20S-25	25ft [7.6m]	450°/460°F [232°/238°C]	0.020
	450-20S	1lb [450g]		
450-20R 95% Tin, 5% Antimony	450-20R-25	25ft [7.6m]	450°/460°F [232°/238°C]	0.020
	450-20R	1lb [450g]		
570-28R 93% Lead, 5.2% Tin, 1.5% Silver	570-28R-20	20ft [6.1m]	565°/574°F [296°/301°C]	0.028
	570-28R	1lb [450g]		

FLUXES

Although some of the solders described in the table have rosin-flux cores, it is often necessary to use separate, externally applied fluxes. This may be the case, for instance, when soldering fine jumper wires to gage tabs or printed-circuit terminals, because not enough flux is released from the cored solder. It may also be necessary to supplement the cored flux in high-temperature solders such as Type 570.

Two fluxing compounds are available for strain gage soldering applications. M-Flux AR is an activated rosin flux which is effective on constantan, copper, nickel, and K-alloy gages with DP soldering pads. M-Flux SS is a very active acid flux which is used primarily with solid-wire solders applied to isoelastic, Nichrome®, and stainless steel. The two fluxes should never be mixed. Whether the rosin or acid flux is used, it must be completely removed immediately after soldering to prevent degradation of protective coatings and

corrosion of the metals, and to eliminate conductive flux residues. Rosin residues are best removed with *M-LINE* Rosin Solvent. Removal of M-Flux SS requires two steps: liberal applications of M-Prep Conditioner A, which must be blotted dry; and then M-Prep Neutralizer 5A, also to be blotted dry.

FLUX AND ROSIN SOLVENT KITS

M-Flux AR Kit FAR-1
2 1-oz (30-ml) brush-cap bottles M-Flux AR 2 1-oz (30-ml) brush-cap bottles M-LINE Rosin Solvent
M-LINE Rosin Solvent Kit RSK-4
4 1-oz (30-ml) brush-cap bottles
M-Flux SS Kit FSS-1
1 1-oz (30-ml) applicator cap bottle M-Flux SS 1 1-oz (30-ml) brush-cap bottle M-Prep Conditioner A 1 1-oz (30-ml) brush-cap bottle M-Prep Neutralizer 5A

Note 1: Products shown in bold are not RoHS compliant.

Solders, Fluxes, Kits and Soldering
Units for Transducer Applications

MARK V SOLDERING STATION

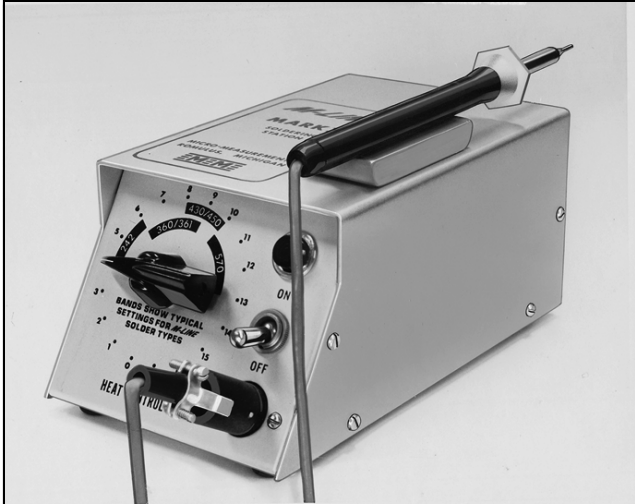

A time-proven precision soldering instrument for miniature and/or delicate soldering applications. Full 25-watt rating in 17 selector positions to handle all *M-LINE* solder alloys listed on page 52. Magnetic solder pencil holder and flexible, burn-resistant cord. Lightweight soldering pencil [1.1oz (31g)]. Operates on 50 or 60Hz. Specify 115 or 230Vac.

- M5S-1** Mark V Soldering Station, Complete
- M5S-2** Mark V Control Unit Only
- M5S-3** Mark V Soldering Pencil Only

Soldering Tips for Mark V

- M5S-A** Type A, general-purpose 1/16in (1.5mm) screwdriver.
- M5S-B** Type B, miniature 1/16in (1.5mm) chisel.
- M5S-C** Type C, heavy duty 1/8in (3mm) screwdriver.
- M5S-D** Type D, high-temperature 3/32in (2.5mm) chisel.

Types A, B, and C tips are pretinned, ironclad copper, overlaid with nickel/chromium to retard oxidation. Type D is nickel-plated copper, particularly suited to high-temperature soldering.

MARK IX SOLDERING STATION



with strain gages. The Mark IX incorporates closed-loop control technology for precise tip temperature management. Tip temperature range of +500° to +800°F [+260° to +425°C] is ideal for most laboratory and field strain gage applications. The temperature control is color-coded for proper tip temperatures for all Micro-Measurements soft solders. Not for use with Type 1240-FPA solder.

- M9S-1-115** Mark IX Soldering Unit, Complete, Voltage 115
- M9S-1-230** Mark IX Soldering Unit, Complete, Voltage 230
- M9S-1-230-CE** Mark IX Soldering Unit, Complete, Voltage 230, CE Version

SOLDERING TIPS FOR MARK IX

- M9S-A** Narrow tip 0.047 in [1.2mm] screwdriver.
- M9S-B** Wide tip 0.062 in [1.6mm] screwdriver.
- M9S-RS** Replacement Sponge, package of 1.

Manufactured for Micro-Measurements, the Mark IX is a compact soldering unit with a lightweight soldering pencil. The modular design of the pencil allows for easy changing of tips, and heating element replacement. Includes both the M9S-A and M9S-B soldering tips, selected for ease of use

General Information and Selection for Transducer Applications

WIRE AND CABLE CODING SYSTEM					
Number of Conductors		4 26		— D F V	
AWG (American Wire Gauge) Wire Size					
Types of Wire		Construction		Insulation	
A: Solid copper		F: Flat cable		N: Nylon/polyurethane enamel	
B: Stranded copper		S: Shielded/twisted with jacket		P: Polyurethane enamel	
D: Tinned stranded copper		T: Twisted cable without jacket		Q: Polyimide enamel	
F: Silver-plated stranded		W: Round single wire		T: TFE Teflon®	
H: Solid Manganin				V: Vinyl (PVC)	
J: Solid Balco®					

AWG	Diameter (nominal)		AWG	Diameter (nominal)	
	in	[mm]		in	[mm]
26	0.0159	0.404	36	0.0050	0.127
30	0.0100	0.254	37	0.0045	0.114
34	0.0063	0.160	42	0.0025	0.064

Balco is a registered trademark of W.B. Driver Company.
Teflon is a registered trademark of DuPont.

SINGLE-CONDUCTOR TYPES: SOLID WIRE		
Type	Packaging	Description
	Foot [Meter]*	
134-AWP 136-AWP	500ft/150m 500ft/150m	Solid copper wire, polyurethane enamel: General-purpose intragage hookup wire. Useful from -100° to +300°F (-75° to +150°C). Enamel coating easily removed by applying heat from soldering iron.
134-AWN 136-AWN	500ft/150m 500ft/150m	Solid copper wire, nylon/polyurethane enamel: Identical in use and specifications to Type AWP above, but with superior abrasion resistance and slightly reduced insulation resistance at elevated temperatures. 134-AWN is available in four colors; specify: -R (red), -W (white), -B (black), -G (green).
130-AWQ 134-AWQ	500ft/150m 500ft/150m	Solid copper wire, polyimide enamel: Intragage hookup wire. Temperature range -452° to +600°F (-269° to +315°C) short term. Enamel is extremely tough and abrasion resistant, with excellent electrical properties; generally removed by mechanical scraping or sanding.
137-HWN	200ft/60m	Solid manganin wire, nylon/polyurethane enamel: Used for bridge balance and span set in transducer circuits. Nominal resistance: 14 ohms/ft (46 ohms/m). Temperature range: +15° to +120°F (-10° to +50°C).
142-JWN	500ft/150m	Solid Balco wire, nylon/polyurethane enamel: Used for bridge temperature compensation of zero shift or span. Nominal resistance: 19 ohms/ft (62 ohms/m). Temperature coefficient of resistance: +0.25%/°F (+0.45%/°C). Temperature range: -15° to +300°F (-10° to +150°C).

General Information and Selection for Transducer Applications

FOUR-CONDUCTOR CABLE		
Type (See Note 1)	Packaging	Description
	Foot [Meter]*	
426-DFV	100ft/30m	Stranded tinned-copper wire, 4-conductor flat cable, vinyl insulation: For use from -60° to +180°F (-50° to +80°C). Conductors easily separated for stripping and wiring. Color-coded red/white/black/green.
426-DFV	1000ft/300m	
430-DFV	100ft/30m	
430-DFV	1000ft/300m	
426-DTV	100ft/30m	Stranded tinned-copper wire, 4-conductor twisted cable, vinyl insulation: For use from -60° to +180°F (-50° to +80°C). Color-coded red/white/black/green. Outside diameter 0.10in (2.5mm) nominal.
426-DTV	1000ft/300m	
426-BSV	100ft/30m	Stranded copper wire, 4-conductor twisted cable, PVC insulated braided shield: For use from -60° to +180°F (-50° to +80°C). Outside diameter of jacket: 0.15in (3.8mm) nominal.
426-BSV	1000ft/300m	
430-FST	100ft/30m	Stranded silver-plated copper wire, 4-conductor twisted cable, Teflon insulation, braided shield, Teflon jacket: Small, flexible cable. For use from -452° to +500°F (-269° to +260°C). Color-coded red/white/black/green. Outside diameter of jacket: 0.12in (3mm) nominal.
430-FST	1000ft/300m	

*Some types may not be continuous length.

References: Application Note: TT-601, Techniques for Bonding Leadwires to Surfaces Experiencing High Centrifugal Forces.
 Application Note: TT-604, Leadwire Attachment Techniques for Obtaining Maximum Fatigue Life of Strain Gages.
 Application Note: TT-608, Techniques for Attaching Leadwires to Unbonded Strain Gages.

Note 1: Products shown in bold are not RoHS compliant.

Protective Coating



FEATURES

- Easy to use
- Transparent
- Good general-purpose coating for laboratory use



RoHS
COMPLIANT

DESCRIPTION

Air-drying solvent-thinned (xylene) polyurethane. Transparent. Moderate hardness; good flexibility. Can be removed with *M-LINE* Rosin Solvent or toluene. Film thickness 0.005-0.01 in [0.1-0.25mm] per coat.

General-purpose coating for lab use, and as base coating for field applications. Must be fully cured before addition of other coatings. Fair moisture resistance. Not readily attacked by many solvents. Convenient to use.

CHARACTERISTICS

Cure Requirements:

Dries tack-free at room temperature in 20 minutes. Completely dry in 2 hours.

Normal cure 24 hours at room temperature. Chemical resistance and coating hardness increase for 6 to 7 days.

Operating Temperature Range:

Short Term: -100° to +300°F [-75° to +150°C].

Long Term: -100° to +250°F [-75° to +120°C].

Shelf Life:

Minimum 1 year at +75°F [+24°C].

PACKAGING OPTIONS

Kit:

4 brush-cap bottles (1oz [30ml] ea)

Bulk:

Quart container

Protective Coating



FEATURES

- Good resistance to chemicals
- Air drying
- Also used for priming leadwires



RoHS
COMPLIANT

DESCRIPTION

Air-drying solvent-thinned (MEK) nitrile rubber. Forms flexible rubbery coating. Do not use directly on exposed foil or bare leads. Often used to prime vinyl-insulated wire to improve bondability to other coatings. If used as primer on

leads, thin 50:50 with MEK. Flexible at cryogenic temperatures. Excellent resistance to gasoline, kerosene, commercial oils. Electrical properties poorer than other M-Coats, particularly at elevated temperatures.

CHARACTERISTICS

Cure Requirements:

Air-dries in 1 hour at +75°F [+24°C]. Do not apply subsequent protective coatings for at least 2 hours from time of application. Normal cure 24 hours at room temperature.

Further improve chemical resistance with 1 hour bake at +200°F [+95°C].

Operating Temperature Range:

Short Term: -320° to +300°F [-195° to +150°C].

Long Term: -320° to +200°F [-195° to +95°C].

Shelf Life:

Minimum 1 year at +75°F [+24°C].

PACKAGING OPTIONS

Kit:

4 brush-cap bottles (1oz [30ml] ea)

Bulk:

Quart container

Protective Coating



FEATURES

- Air drying
- Low reinforcement
- Transparent



RoHS
COMPLIANT

DESCRIPTION

Solvent-thinned (naphtha) RTV silicone rubber. Cures to tough, rubbery transparent film. Good all-around mechanical and electrical properties. Completely noncorrosive. Film thickness 0.015-0.02 in [0.4-0.5mm] per coat.

Recommended for lab and field installations that require a high degree of protection in thin coatings. Good water-splash protection. Good chemical resistance.

CHARACTERISTICS

Cure Requirements:

Solvents evaporate in about 60 minutes at room temperature. Allow 20 minutes drying time between coats.

Cures in 24 hours at +75°F [+24°C] and 50% RH. Longer cure at lower humidity.

Operating Temperature Range:

Short Term: -75° to +550°F [-60° to +290°C].

Long Term: -75° to +500°F [-60° to +260°C].

Shelf Life:

Minimum 9 months at +75°F [+24°C] kept tightly sealed.

PACKAGING OPTIONS

Kit:

4 brush-cap bottles (1 oz [30ml] ea)

Bulk:

Quart container

Protective Coating

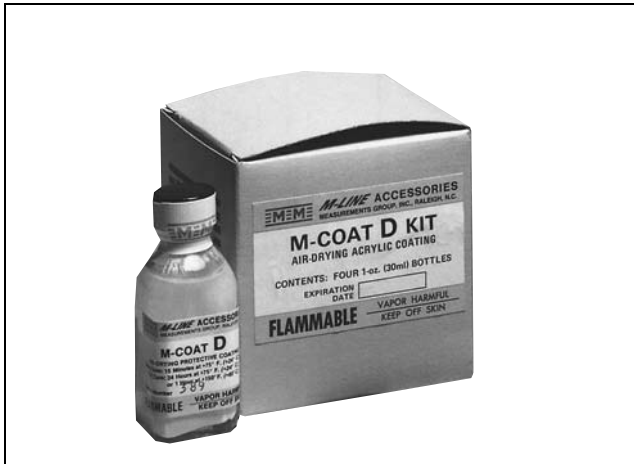

FEATURES

- Air drying
- Opaque
- Good base coating



RoHS
COMPLIANT

DESCRIPTION

Air-drying solvent-thinned (toluene) acrylic. Dense white color for easy visual inspection of coverage. Forms hard thin coating capable of high elongation. Can be removed with *M-LINE* Rosin Solvent or toluene. Apply in thin coats to prevent solvent entrapment. Film thickness 0.005-0.01 in [0.1-0.25mm] per coat.

Good general laboratory moisture barrier. Electrical leakage negligible even when uncured. Good base coating for subsequent applications of M-Coat B. Convenient for anchoring and insulating intrabridge wiring and jumper leads. Chemical resistance only fair but can be improved by postcure at +175°F [+80°C] for 30 minutes.

CHARACTERISTICS

Cure Requirements:

Air dry for 15 minutes then cure for 24 hours at +75°F [+24°C] or one hour at +150°F [+65°C]. Overcoats can be applied 30 minutes from time of application. Coating binder begins to sublimate at +280°F [+140°C], but residue is inorganic and will not become conductive.

Operating Temperature Range:

Short Term: -100° to +325°F [-75° to +160°C].

Long Term: -100° to +250°F [-75° to +120°C].

Shelf Life:

Minimum 1 year at +75°F [+24°C] kept tightly sealed.

PACKAGING OPTIONS

Kit:

4 brush-cap bottles (1oz [30ml] ea)

Bulk:

Quart container

Protective Coating



FEATURES

- Excellent protection from moisture
- Low reinforcement
- Easy to apply



RoHS
COMPLIANT

DESCRIPTION

Solvent-thinned butyl rubber designed to provide excellent moisture protection with low reinforcement effects. Principally used in transducers. Exhibits a paste-like

consistency and is normally applied with a spatula. Thickness over 0.1 in [2.5mm] not recommended.

CHARACTERISTICS

Cure Requirements:

Air dry 8 hours, followed by an elevated temperature cure of +150° to +175°F [+65° to +80°C] for 4 to 6 hours.

Operating Temperature Range:

0° to +175°F [-20° to +80°C].

Shelf Life:

Minimum 12 months at +75°F [+24°C].

PACKAGING OPTIONS

Kit:

75g collapsible tubes, 4 each

Bulk:

Quart container

Protective Coating



FEATURES

- Outstanding moisture protection
- Easy to apply
- No cure required



RoHS
COMPLIANT

DESCRIPTION

Microcrystalline wax. Has very low water-vapor transmission rate. Attacked by most solvents. Coating thickness 0.015-0.06 in [0.4-1.5mm].

Excellent water-immersion coating. Poor mechanical protection. Often used as an intermediate coating.

CHARACTERISTICS

Application Requirements:

Heat to at least +170°F [+75°C] to melt. For best wetting and sealing, heat specimen surface to at least +100°F [+45°C] before applying.

No cure required.

Operating Temperature Range:

0° to +150°F [-20° to +65°C].

Shelf Life:

No limit.

PACKAGING OPTIONS

Kit:

5 tins (1oz [28g] ea)

Bulk:

1 package (5lb [2.25kg])

Protective Coating



FEATURES

- Easy to use
- Translucent
- Self-leveling
- Room-temperature cure



RoHS
COMPLIANT

DESCRIPTION

Single-component 98%-solids RTV silicone rubber. Room-temperature cure (humidity-reactive). Completely non-corrosive. Forms tough, rubbery coating. Excellent properties. Translucent; permits full inspection of installation. Self-leveling; forms fairly thick coats 0.03-0.06 in [0.75-1.5mm].

Easy-to-apply general-purpose coating. Lab and field use. Low reinforcing effects. High-elongation capabilities. Good for short-term water immersion. Resists many chemicals. Bonds to contaminated surfaces for short-term tests; for best long-term protection, chemically clean surface and prime with *M-LINE* RTV Primer No. 1.

CHARACTERISTICS

Cure Requirements:

Tack-free in approximately 2 hours.

Cure 24 hours at +75°F [+24°C], 50% RH for each 0.02-in [0.5-mm] thickness. Longer cure at lower humidity levels.

Note: Will not cure properly if coating is not exposed to atmosphere.

Operating Temperature Range:

Short Term: -100° to +600°F [-75° to +315°C].

Long Term: -65° to +500°F [-55° to +260°C].

Shelf Life:

Minimum 6 months at +75°F [+24°C].

PACKAGING

Kit:

1 collapsible metal tube (3oz [85g])

Accessory:

4 brush-cap bottles (1oz [30ml] ea) RTV Primer No. 1

Protective Coating



FEATURES

- Easy to use
- Good mechanical protection
- Good cable anchor
- Room-temperature cure



RoHS
COMPLIANT

DESCRIPTION

Single-component 98%-solids RTV silicone rubber. Room temperature cure (humidity-reactive). Completely non-corrosive. Forms tough, rubbery coating. Excellent properties. Opaque gray coating of higher strength and toughness than 3140 RTV. Not self-leveling.

Easy-to-apply general-purpose coating. Lab and field use. Low reinforcing effects. High-elongation capabilities. Good

for short-term water immersion. Resists many chemicals. Bonds to contaminated surfaces for short-term tests; for best long-term protection, chemically clean surface and prime with *M-LINE* RTV Primer No. 1. Very thick coatings can be applied without sag or runoff. Tear strength much higher than 3140. Good cable anchor.

CHARACTERISTICS

Cure Requirements:

Tack-free in approximately 2 hours.

Cure 24 hours at +75°F [+24°C], 50% RH for each 0.02-in [0.5-mm] thickness. Longer cure at lower humidity levels.

Note: Will not cure properly if coating is not exposed to atmosphere.

Operating Temperature Range:

Short Term: -100° to +600°F [-75° to +315°C].

Long Term: -65° to +500°F [-55° to +260°C].

Shelf Life:

Minimum 6 months at +75°F [+24°C].

PACKAGING OPTIONS

Kit:

1 collapsible metal tube (3oz [85g])

Accessory:

4 brush-cap bottles (1oz [30ml] ea) RTV Primer No. 1

Strain Gage Application Kit for Transducers

It is often of greatest convenience for the strain gage user to purchase all of the needed accessory supplies and materials in a single package. For this purpose, Micro-Measurements offers the TAK-610 Strain Gage Application Kit. Kit contents are available separately. Refer to the appropriate sections of this catalog for specific component details.



TAK-610 KIT CONTENTS

- M-Bond 610 Kit
- CSM-2 Degreaser, 1 can
- MCA-1 Conditioner A, 1 bottle
- MN5A-1 Neutralizer 5A, 1 bottle
- SCP-1 220 grit, 1 roll, 100 ft [30 m]
- SCP-2 320 grit, 1 roll, 100 ft [30 m]
- SCP-3 400 grit, 1 roll, 100 ft [30 m]
- CSP-1 Cotton Swabs, 1 package
- GSP-1 Gauze Sponges, 1 package
- MJG-2 Mylar Tape, 1 roll
- PDT-1 Paper Drafting Tape, 1 roll
- 361A-20R-25 Solder, 1 roll, 25 ft [7.6 m]
- FAR-1 Rosin Flux Kit
- CPF-AST Bondable Terminals, 1 box
- 426-DFV, 4-Conductor Leadwire, 100 ft [30 m]
- M-Coat C, 1 oz [30 ml]
- 134-AWP Solid Copper Wire, 500 ft [150 m]
- SGP-2 Silicone Rubber, 1 piece
- HSC-1 No. 1 Spring Clamp, 4 each
- TFE-1 Teflon Film, 1 roll
- BTW-1 Blunt-Nose Tweezers
- Plastic Tool Box

Transducer Application Software

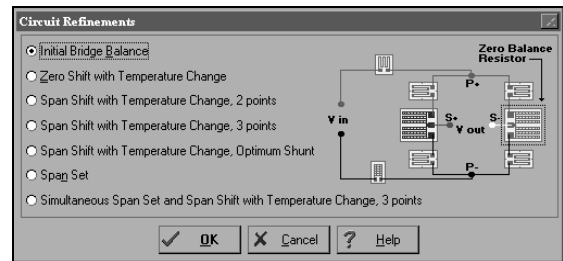
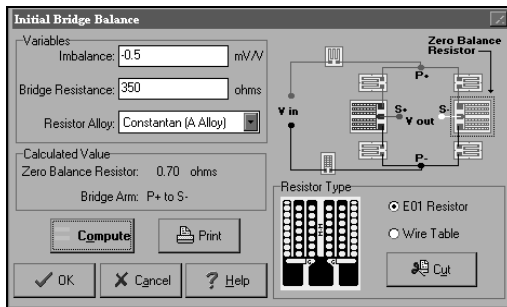

TransCalc™ is a valuable resource for the transducer designer, providing:

- Design verification calculations of surface strain, strain variation, and bridge output for 15 common transducer shapes; user-selectable US Customary or SI units.
- Circuit refinement computations of zero balance, zero-shift-with-temperature change, span-shift-with-temperature change, and span set.
- Interactive graphical resistor-adjustment guidelines.
- Intuitive Windows™ user interface.
- Built-in wire tables for computing length or resistance of wire necessary for the transducer circuit.
- Calculation of bridge outputs for six different Wheatstone-bridge configurations.
- In-depth reference material for:
 - Spring element design considerations
 - Resistor selection guidelines
 - Materials properties
 - Bridge adjustment and compensation circuitry

www.vishaypg.com



Data Book

Transducer-Class[®] Strain Gages Micro-Measurements

www.micro-measurements.com

VMM-DB0104-1105

Where the World Goes
for Precision Measurement and Control

© Copyright 2011 Vishay Precision Group. ® Registered trademarks of Vishay Precision Group.
All rights reserved. Printed in USA. Specifications subject to change without notice.