

# Strain Gage Accessories

## Micro-Measurements

Adhesives  
Protective Coatings  
Surface Cleaning  
Installation Tools  
Bondable Terminals  
Wire and Cable  
Application Kits  
Solder and Flux



**INTERACTIVE** Data Book  
VMM-DB0101-1007

Click on the VPG logo on any datasheet to go to the contents page for that section.

Click on the VPG logo on any contents page to go to the main table of contents page.

## The Americas

**United States** **Vishay Precision Group – Micro-Measurements**  
P.O. Box 27777 • Raleigh, NC 27611  
Ph: +1-919-365-3800 • Fax: +1-919-365-3945  
E-mail: [mm.us@vishaypg.com](mailto:mm.us@vishaypg.com)

## Asia

**P.R. China** **Vishay Precision Group – Micro-Measurements**  
A8220, Shanghai Jia Hua Business Center  
No. 808 Hong Qiao Road • Shanghai 200030  
Ph: +86-21-6448-6090, Ext. 6098 • Fax: +86-21-6448-6070  
E-mail: [mm.cn@vishaypg.com](mailto:mm.cn@vishaypg.com)

## Europe

**France** **Vishay Precision Group – Micro-Measurements**  
16 Rue Francis Vovelle • 28000 Chartres  
Ph: +33-2-37-33-31-20 • Fax: +33-2-37-33-31-29  
E-mail: [mm.fr@vishaypg.com](mailto:mm.fr@vishaypg.com)

**Germany** **Vishay Precision Group – Micro-Measurements**  
Tatschenweg 1 • 74078 Heilbronn  
Ph: +49-7131-39099-0 • Fax +49-7131-39099-229  
E-mail: [mm.de@vishaypg.com](mailto:mm.de@vishaypg.com)

**Spain** **Vishay Precision Group – Micro-Measurements**  
C/Copenhagen, N°4, 6 y 8 - Planta 1ª - Oficina 12 • Edificio Al Andaluz  
Polígono Európolis • 28232 Las Rozas, Madrid  
Ph: +34-916-407-624 • Fax: +34-916-375-601  
E-mail: [mm.es@vishaypg.com](mailto:mm.es@vishaypg.com)

**United Kingdom** **Vishay Precision Group – Micro-Measurements**  
Stroudley Road • Basingstoke • Hampshire RG24 8FW  
Ph: +44-(0)125-646-2131 • Fax: +44-(0)125-647-1441  
E-mail: [mm.uk@vishaypg.com](mailto:mm.uk@vishaypg.com)

# Strain Gage Accessories

**Vishay Precision Group**  
**Micro-Measurements**  
P.O. Box 27777  
Raleigh, NC 27611  
U.S.A.  
**Phone:** +1 919 365 3800  
**Fax:** +1 919 365 3945  
[www.micro-measurements.com](http://www.micro-measurements.com)

## **DISCLAIMER**

All product specifications and data are subject to change without notice.

Vishay Precision Group, Inc., its affiliates, agents, and employees, and all persons acting on its or their behalf (collectively, "Vishay Precision Group"), disclaim any and all liability for any errors, inaccuracies or incompleteness contained herein or in any other disclosure relating to any product.

Vishay Precision Group disclaims any and all liability arising out of the use or application of any product described herein or of any information provided herein to the maximum extent permitted by law. The product specifications do not expand or otherwise modify Vishay Precision Group's terms and conditions of purchase, including but not limited to the warranty expressed therein, which apply to these products.

No license, express or implied, by estoppel or otherwise, to any intellectual property rights is granted by this document or by any conduct of Vishay Precision Group.

The products shown herein are not designed for use in medical, life-saving, or life-sustaining applications unless otherwise expressly indicated. Customers using or selling Vishay Precision Group products not expressly indicated for use in such applications do so entirely at their own risk and agree to fully indemnify Vishay Precision Group for any damages arising or resulting from such use or sale. Please contact authorized Vishay Precision Group personnel to obtain written terms and conditions regarding products designed for such applications.

Product names and markings noted herein may be trademarks of their respective owners.

### Strain Gage Accessories

#### STRAIN GAGE ACCESSORIES

Contents .....	1
Alphabetical Index .....	6
General Information and Selection Guide .....	10

#### SURFACE CLEANING SUPPLIES

CSM-2	Degreaser .....	14
GC-6	Isopropyl Alcohol .....	14
MCA-1	Conditioner A .....	15
MCA-2	Conditioner A (bulk) .....	15
MN5A-1	Neutralizer 5A .....	15
MN5A-2	Neutralizer 5A (bulk) .....	15
SCP-1	220-Grit Wet-or-Dry Silicon-Carbide Paper .....	15
SCP-2	320-Grit Wet-or-Dry Silicon-Carbide Paper .....	15
SCP-3	400-Grit Wet-or-Dry Silicon-Carbide Paper .....	15
GC-5	Pumice Powder .....	15
TEC-1	Tetra-Etch® Compound .....	15
CSP-1	Cotton Swabs .....	15
GSP-1	Gauze Sponges .....	15

#### STRAIN GAGE ADHESIVES

General Information and Selection Guide .....	18	
M-Bond 200	Cyanoacrylate .....	20
M-Bond AE-10	2-Component, 100%-Solids Epoxy .....	21
M-Bond AE-15	2-Component, 100%-Solids Epoxy .....	22
M-Bond 610	2-Component, Solvent-thinned, Epoxy-phenolic .....	23
M-Bond 600	2-Component, Solvent-thinned, Epoxy-phenolic .....	24
M-Bond 43-B	Single-Component, Solvent-thinned Epoxy .....	25
M-Bond GA-61	2-Component, Partially Filled, 100%-Solids Epoxy .....	26
M-Bond GA-2	2-Component, Partially Filled, 100%-Solids Epoxy .....	27
M-Bond A-12	2-Component, 100%-Solids Epoxy .....	28
M-Bond 300	2-Component, Polyester .....	29
M-Bond 450	2-Component, Solvent-thinned Epoxy .....	30
Denex #3	Single-Component, Solvent-thinned Epoxy .....	31
EpoxyLite 813	2-Component, 100%-Solids Epoxy .....	32
GC Cement	Single-Component, Ceramic .....	33
H Cement	Single-Component, Ceramic .....	34
P Adhesive	Single-Component, Solvent-thinned, Polyimide .....	35
PBX Cement	2-Component, Ceramic .....	36
Sauereisen DKS-8	Single-Component, Inorganic, Zircon-based .....	37
RTC Epoxy	General-Purpose .....	38
EPY-500	2-Component, Filled Epoxy, bi-pack .....	39
QA-500	2-Component, Filled Epoxy, bi-pack .....	40

#### INSTALLATION TOOLS AND ACCESSORIES

SSH-1	Surgical Shears .....	42
STW-1	Tweezers, Ground, Sharp Ends .....	42
BTW-1	Tweezers, Flat, Blunt Ends .....	42
DPR-1	Dental Probe .....	42
SSC-1	Surgical Scalpel and Blades .....	42
SSC-2	Replacement Scalpel Blades .....	42
SSS-1	Steel Scale (Inches) .....	42
SSS-2	Steel Scale (Inches and Millimeters) .....	42
DP-1	4-H Drafting Pencil .....	42
DWC-1	Diagonal Cutters .....	42

## INSTALLATION TOOLS AND ACCESSORIES (CONTINUED)

NNP-1	Needle-Nosed Pliers .....	42
ATS-2	Gage Application Tool Set .....	42
GT-11	Camel's Hair Brush .....	43
SPT-1	Stainless Steel Mixing Spatula, Double Blade .....	43
SPT-2	Stainless Steel Mixing Spatula, Single Blade .....	43
HTC-1	Temperature Controlled Hotplate .....	43
MHG-1	Master Mite Heat Gun, 120 Vac .....	43
MHG-2	Master Mite Heat Gun, 220 Vac .....	43
PCT-2M	Gage Installation Tape .....	43
PDT-1	Paper Drafting Tape .....	43
PLY-001	Kapton <sup>®</sup> Film .....	43
MJG-2	Mylar <sup>®</sup> Tape .....	44
TFT-1	Thermosetting Fiberglass Tape .....	44
FGC-1	Woven Fiberglass Cloth .....	44
TFE-2	High-Modulus TFE Teflon <sup>®</sup> with Silicone Mastic .....	44
HSC-1	Spring Clamp .....	44
HSC-2	Spring Clamp .....	44
HSC-3	Spring Clamp .....	44
GT-12	Neg'ator Constant Force Extension Spring Clamp .....	44
TFE-1	Teflon Film .....	44
GT-14	Pressure Pads and Backup Plates .....	44
SGP-1	Silicone Rubber .....	44
SGP-2	Silicone Rubber .....	44

## BONDABLE TERMINALS

Terminal Details and Descriptions .....		46
CEG-25C	Copper Foil, Epoxy-glass Laminate Backing .....	46
CPF-25C	Copper Foil, Polyimide Film Backing .....	46
CEG-38C	Copper Foil, Epoxy-glass Laminate Backing .....	46
CPF-38C	Copper Foil, Polyimide Film Backing .....	46
CEG-50C	Copper Foil, Epoxy-glass Laminate Backing .....	46
CPF-50C	Copper Foil, Polyimide Film Backing .....	46
CEG-75C	Copper Foil, Epoxy-glass Laminate Backing .....	46
CPF-75C	Copper Foil, Polyimide Film Backing .....	46
CEG-100C	Copper Foil, Epoxy-glass Laminate Backing .....	46
CPF-100C	Copper Foil, Polyimide Film Backing .....	46
CEG-150C	Copper Foil, Epoxy-glass Laminate Backing .....	46
CPF-150C	Copper Foil, Polyimide Film Backing .....	46
CEG-50D	Copper Foil, Epoxy-glass Laminate Backing .....	47
CPF-50D	Copper Foil, Polyimide Film Backing .....	47
CEG-60D	Copper Foil, Epoxy-glass Laminate Backing .....	47
CPF-60D	Copper Foil, Polyimide Film Backing .....	47
CEG-75D	Copper Foil, Epoxy-glass Laminate Backing .....	47
CPF-75D	Copper Foil, Polyimide Film Backing .....	47
CEG-100D	Copper Foil, Epoxy-glass Laminate Backing .....	47
CPF-100D	Copper Foil, Polyimide Film Backing .....	47
CEG-60L	Copper Foil, Epoxy-glass Laminate Backing .....	47
CPF-60L	Copper Foil, Polyimide Film Backing .....	47
CEG-75L	Copper Foil, Epoxy-glass Laminate Backing .....	47
CPF-75L	Copper Foil, Polyimide Film Backing .....	47
CEG-AST	Copper Foil, Epoxy-glass Laminate Backing Assortment .....	47
CPF-AST	Copper Foil, Polyimide Film Backing Assortment .....	47
CEG-21S	Copper Foil, Epoxy-glass Laminate Backing .....	47
CEG-42S	Copper Foil, Epoxy-glass Laminate Backing .....	47
CEG-63S	Copper Foil, Epoxy-glass Laminate Backing .....	47
CEG-83S	Copper Foil, Epoxy-glass Laminate Backing .....	47
CEG-125S	Copper Foil, Epoxy-glass Laminate Backing .....	47

## SOLDERS AND ACCESSORIES

361A-20R	Tin-Lead-Antimony Solder .....	50
361-40R	Tin-Lead Solder .....	50
430-20S	Tin-Silver Solder .....	50
450-20R	Tin-Antimony Solder .....	50
450-20S	Tin-Antimony Solder .....	50
570-28R	Lead-Tin-Silver Solder .....	50
1240-FPA	Silver-Zinc-Copper-Nickel Solder .....	50
FAR-1	Rosin Flux Kit .....	51
RSK-1	Rosin Solvent Kit .....	51
RSK-2	Rosin Solvent Bulk .....	51
RSK-4	Rosin Solvent Kit .....	51
FSS-1	Acid Flux Kit .....	51
M5S-1	Mark V Soldering Station .....	51
M5S-2	Mark V Control Unit Only .....	51
M5S-3	Mark V Soldering Pencil Only .....	51
M5S-A	Mark V Soldering Tip, Screwdriver .....	51
M5S-B	Mark V Soldering Tip, Chisel .....	51
M5S-C	Mark V Soldering Tip, Screwdriver .....	51
M5S-D	Mark V Soldering Tip, Chisel .....	51
M8S-1	Mark VIII Soldering Unit .....	52
M8S-A	Mark VIII Soldering Tip, Screwdriver .....	52
M8S-B	Mark VIII Soldering Tip, Screwdriver .....	52
M8S-RS	Mark VIII Replacement Sponge .....	52
WRS-1	Resistance Soldering Unit (110 Vac) .....	52
WRS-2	Resistance Soldering Unit (220 Vac) .....	52
WRS-A	Resistance Soldering Unit Replacement Electrodes .....	52

## WIRE, CABLE AND ACCESSORIES

General Information and Selection .....	54	
134-AWP	Single-Conductor Wire .....	55
136-AWP	Single-Conductor Wire .....	55
127-AWN	Single-Conductor Wire .....	55
130-AWN	Single-Conductor Wire .....	55
134-AWN	Single-Conductor Wire .....	55
127-AWQ	Single-Conductor Wire .....	55
130-AWQ	Single-Conductor Wire .....	55
134-AWQ	Single-Conductor Wire .....	55
126-GWF	Single-Conductor Wire .....	55
137-HWN	Single-Conductor Wire .....	55
142-JWN	Single-Conductor Wire .....	55
126-DWV	Single-Conductor Wire .....	55
126-FWK	Single-Conductor Wire .....	55
130-FWT	Single-Conductor Wire .....	55
322-DJV	Three-Conductor Cable .....	56
326-DFV	Three-Conductor Cable .....	56
330-DFV	Three-Conductor Cable .....	56
326-BSV	Three-Conductor Cable .....	56
326-DTV	Three-Conductor Cable .....	56
326-DSV	Three-Conductor Cable .....	56
330-FFE	Three-Conductor Cable .....	56
330-FJT	Three-Conductor Cable .....	56
330-FTE	Three-Conductor Cable .....	56
336-FTE	Three-Conductor Cable .....	56
326-GJF	Three-Conductor Cable .....	56
426-DFV	Four-Conductor Cable .....	57
430-DFV	Four-Conductor Cable .....	57

# Table of Contents

## WIRE, CABLE AND ACCESSORIES (CONTINUED)

422-DSV	Four-Conductor Cable .....	57
426-BSV	Four-Conductor Cable .....	57
426-DTV	Four-Conductor Cable .....	57
430-FST	Four-Conductor Cable .....	57
436-FTT	Four-Conductor Cable .....	57
426-FFT	Four-Conductor Cable .....	57
1-GL-64-001	Flat Ribbon Lead .....	57
1-KL-16-002	Flat Ribbon Lead .....	57
1-KL-08-003	Flat Ribbon Lead .....	57
1-KL-08-005	Flat Ribbon Lead .....	57
HST-1	Heat-Shrinkable Wire Splice Sealant .....	58
WTS-1	Thermal Wire Stripper (110 Vac) .....	58
WTS-2	Thermal Wire Stripper (220 Vac) .....	58
WTS-A	Thermal Wire Stripper Replacement Elements .....	58

## PROTECTIVE COATINGS

General Information .....		60
M-Coat A	Solvent-thinned (Xylene) Polyurethane .....	62
M-Coat B	Solvent-thinned (MEK) Nitrile Rubber .....	63
M-Coat C	Solvent-thinned (Naphtha) RTV Silicone Rubber .....	64
M-Coat D	Solvent-thinned (Toluene) Acrylic .....	65
M-Coat F	Kit of Materials for Environmental and Mechanical Protection .....	66
M-Coat FBT	Solvent-thinned Butyl Rubber .....	67
M-Coat J	2-Part Polysulfide .....	68
M-Coat W-1	Microcrystalline Wax .....	69
3140 RTV	Single-Component RTV Silicone Rubber .....	70
3145 RTV	Single-Component RTV Silicone Rubber .....	71
M-Bond AE-10 and AE-15	2-Component, 100%-Solids Epoxy used as Protective Coating .....	72
M-Bond 43-B	Single-Component, Solvent-thinned Epoxy used as Protective Coating .....	73
M-Bond GA-61	2-Component, Partially Filled, 100%-Solids Epoxy used as Protective Coating .....	74
Barrier E	Single-Component, Neoprene Patch .....	75
Barrier WD	Single-Component, Paste Wax .....	76
Gagekote #1	Solvent-Thinned, (Toluene) Synthetic Resin .....	77
Gagekote #5	2-Component, 100%-Solids Modified Polysulfide Epoxy .....	78
Gagekote #8	Single-Component, Transparent, Acrylic .....	79
Gagekote #11	Single-Component, Clear .....	80

## STRAIN GAGE APPLICATION KITS

BAK-200	Basic, with M-Bond 200 .....	82
CEA-200	Complete, CEA Strain Gages with M-Bond 200.....	82
GAK-2-200	Complete, with M-Bond 200 .....	82
GAK-2-AE-10	Complete, with M-Bond AE-10 .....	82
GAK-2-610	Complete, with M-Bond 610 .....	82
MAK-1	Master Kit, with M-Bond 200, AE-10 and M-Bond 610 .....	83

## PRECISION RESISTORS

Specifications and Selection Charts .....		86
W-599880-02	Shunt Calibration .....	87
W-119880-02	Shunt Calibration .....	87
S-59880-01	Shunt Calibration .....	87
S-29880-01	Shunt Calibration .....	87
S-19880-01	Shunt Calibration .....	87
S-14880-01	Shunt Calibration .....	87
S-11880-01	Shunt Calibration .....	87
S-5880-01	Shunt Calibration .....	87
W-349650-02	Shunt Calibration .....	87
W-174650-02	Shunt Calibration .....	87



**PRECISION RESISTORS (CONTINUED)**

S-87150-01	Shunt Calibration .....	87
S-57983-01	Shunt Calibration .....	87
S-43400-01	Shunt Calibration .....	87
S-34650-01	Shunt Calibration .....	87
S-17150-01	Shunt Calibration .....	87
W-999000-02	Shunt Calibration .....	87
W-499000-02	Shunt Calibration .....	87
W-249000-02	Shunt Calibration .....	87
W-165666-02	Shunt Calibration .....	87
W-124000-02	Shunt Calibration .....	87
S-99000-01	Shunt Calibration .....	87
S-49000-01	Shunt Calibration .....	87
S-50-01	Bridge Completion .....	87
S-60-01	Bridge Completion .....	87
S-100-01	Bridge Completion .....	87
S-120-01	Bridge Completion .....	87
S-175-01	Bridge Completion .....	87
S-240-01	Bridge Completion .....	87
S-350-01	Bridge Completion .....	87
S-500-01	Bridge Completion .....	87
S-1000-01	Bridge Completion .....	87
S-2000-01	Bridge Completion .....	87
S-5000-01	Bridge Completion .....	87
H-100-01	Bridge Completion .....	87
H-120-01	Bridge Completion .....	87
H-350-01	Bridge Completion .....	87
H-1000-01	Bridge Completion .....	87

**BRIDGE COMPLETION MODULES**

MR1-350-127	.....	90
MR1-10C-129	.....	90
MR1-350-130	.....	90
MR2-350-128	.....	90

**SPECIAL-PURPOSE EQUIPMENT**

Model 1300	Gage Installation Tester .....	92
Model 700	Portable Strain Gage Welding and Soldering Unit.....	94

**TECHNICAL SUPPORT**

Technical Publications	.....	98
Applications Engineering	.....	98
Technical Training	.....	99

# Alphabetical Index

<b>PRODUCT .....</b>	<b>PAGE NO.</b>
ATS-2 .....	42
BAK-200.....	82
Barrier E .....	75
Barrier WD.....	76
BTW-1 .....	42
CEA-200.....	82
CEG-AST.....	47
CEG-21S.....	47
CEG-25C.....	46
CEG-38C.....	46
CEG-42S.....	47
CEG-50C.....	46
CEG-50D.....	47
CEG-60D.....	47
CEG-60L.....	47
CEG-63S.....	47
CEG-75C.....	46
CEG-75D.....	47
CEG-75L.....	47
CEG-83S.....	47
CEG-100C.....	46
CEG-100D.....	47
CEG-125S.....	47
CEG-150C.....	46
CPF-AST.....	47
CPF-25C.....	46
CPF-38C.....	46
CPF-50C.....	46
CPF-50D.....	47
CPF-60D.....	47
CPF-60L.....	47
CPF-75C.....	46
CPF-75D.....	47
CPF-75L.....	47
CPF-100C.....	46
CPF-100D.....	47
CPF-150C.....	47
CSM-2.....	14
CSP-1.....	15
Denex #3.....	31
DP-1.....	42
DPR-1.....	42
DWC-1.....	42
EpoxyLite 813.....	32

<b>PRODUCT.....</b>	<b>PAGE NO.</b>
EPY-500 .....	39
FAR-1 .....	51
FGC-1.....	44
FSS-1.....	51
Gagekote #1 .....	77
Gagekote #5.....	78
Gagekote #8.....	79
Gagekote #11.....	80
GAK-2-AE-10.....	82
GAK-2-200.....	82
GAK-2-610.....	82
GC Cement.....	33
GC-5.....	15
GC-6.....	14
GSP-1.....	15
GT-11.....	43
GT-12.....	44
GT-14.....	44
H Cement.....	34
H-100-01.....	87
H-120-01.....	87
H-350-01.....	87
H-1000-01.....	87
HSC-1.....	44
HSC-2.....	44
HSC-3.....	44
HST-1.....	58
HTC-1.....	43
MAK-1.....	83
M-Bond A-12.....	28
M-Bond AE-10.....	21
M-Bond AE-10, Used as Protective Coating.....	72
M-Bond AE-15.....	22
M-Bond AE-15, Used as Protective Coating.....	72
M-Bond GA-2.....	27
M-Bond GA-61.....	26
M-Bond GA-61, Used as Protective Coating.....	74
M-Bond 200.....	20
M-Bond 300.....	29
M-Bond 43-B.....	25
M-Bond 43-B, Used as Protective Coating.....	73
M-Bond 450.....	30
M-Bond 600.....	24
M-Bond 610.....	23

PRODUCT .....	PAGE NO.	PRODUCT .....	PAGE NO.
MCA-1 .....	15	SCP-1 .....	15
MCA-2 .....	15	SCP-2 .....	15
M-Coat A .....	62	SCP-3 .....	15
M-Coat B .....	63	SGP-1 .....	44
M-Coat C .....	64	SGP-2 .....	44
M-Coat D .....	65	SPT-1 .....	43
M-Coat F .....	66	SPT-2 .....	43
M-Coat FBT .....	67	SSC-1 .....	42
M-Coat J .....	68	SSC-2 .....	42
M-Coat W-1 .....	69	SSH-1 .....	42
MHG-1 .....	43	SSS-1 .....	42
MHG-2 .....	43	SSS-2 .....	42
MJG-2 .....	44	STW-1 .....	42
MN5A-1 .....	15	S-50-01 .....	87
MN5A-2 .....	15	S-60-01 .....	87
Model 700 .....	94	S-100-01 .....	87
Model 1300 .....	92	S-120-01 .....	87
MR1-10C-129 .....	90	S-175-01 .....	87
MR1-350-127 .....	90	S-240-01 .....	87
MR1-350-130 .....	90	S-350-01 .....	87
MR2-350-128 .....	90	S-500-01 .....	87
M5S-A .....	51	S-1000-01 .....	87
M5S-B .....	51	S-2000-01 .....	87
M5S-C .....	51	S-5000-01 .....	87
M5S-D .....	51	S-5880-01 .....	87
M5S-1 .....	51	S-11880-01 .....	87
M5S-2 .....	51	S-14880-01 .....	87
M5S-3 .....	51	S-17150-01 .....	87
M8S-A .....	52	S-19880-01 .....	87
M8S-B .....	52	S-29880-01 .....	87
M8S-RS .....	52	S-34650-01 .....	87
M8S-1 .....	52	S-43400-01 .....	87
NNP-1 .....	42	S-49000-01 .....	87
P Adhesive .....	35	S-57983-01 .....	87
PBX Cement .....	36	S-59880-01 .....	87
PCT-2M .....	43	S-87150-01 .....	87
PDT-1 .....	43	S-99000-01 .....	87
PLY-001 .....	43	TEC-1 .....	15
QA-500 .....	40	TFE-1 .....	44
RSK-1 .....	51	TFE-2 .....	44
RSK-2 .....	51	TFT-1 .....	44
RSK-4 .....	51	WRS-A .....	52
RTC Epoxy .....	38	WRS-1 .....	52
Sauereisen DKS-8 .....	37	WRS-2 .....	52

# Alphabetical Index

<b>PRODUCT .....</b>	<b>PAGE NO.</b>	<b>PRODUCT.....</b>	<b>PAGE NO.</b>
WTS-A.....	58	142-JWN .....	55
WTS-1 .....	58	322-DJV.....	56
WTS-2 .....	58	326-BSV .....	56
W-119880-02 .....	87	326-DFV .....	56
W-124000-02 .....	87	326-DSV .....	56
W-165666-02 .....	87	326-DTV .....	56
W-174650-02 .....	87	326-GJF.....	56
W-249000-02 .....	87	330-DFV .....	56
W-349650-02 .....	87	330-FFE.....	56
W-499000-02 .....	87	330-FJT .....	56
W-599880-02 .....	87	330-FTE.....	56
W-999000-02 .....	87	336-FTE.....	56
1-GL-64-001 .....	57	361-40R.....	50
1-KL-08-003.....	57	361A-20R .....	50
1-KL-08-005.....	57	422-DSV .....	57
1-KL-16-002.....	57	426-BSV .....	57
126-DWV .....	55	426-DFV .....	57
126-FWK .....	55	426-DTV .....	57
126-GWF.....	55	426-FFT .....	57
127-AWN.....	55	430-DFV .....	57
127-AWQ .....	55	430-FST.....	57
130-AWN.....	55	430-20S.....	50
130-AWQ .....	55	436-FTT .....	57
130-FWT .....	55	450-20R.....	50
134-AWN.....	55	450-20S.....	50
134-AWP .....	55	570-28R.....	50
134-AWQ .....	55	1240-FPA.....	50
136-AWP .....	55	3140 RTV.....	70
137-HWN .....	55	3145 RTV .....	71



## Contents

General Information and Selection Guide.....	10
--	----

# General Information and Selection Guide

## General Information and Selection Guide

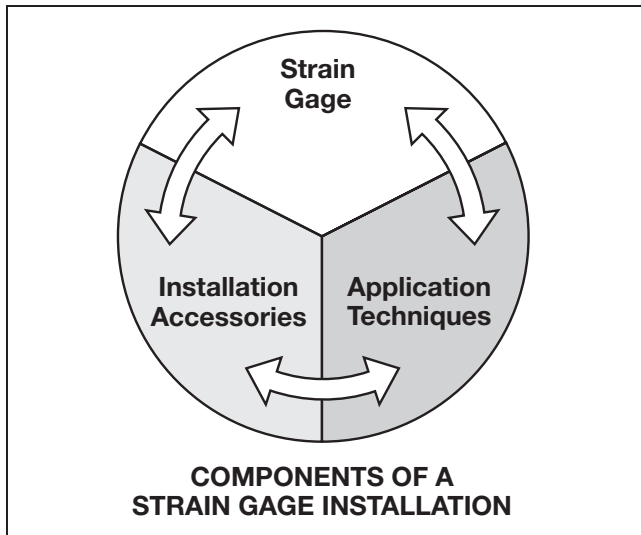

This databook describes a wide range of accessories used for installation of electrical resistance strain gages. These accessories have been developed and selected specifically for their effectiveness and ease of use in making strain gage installations. They have also been carefully tested for their reliability and consistency of properties. The range of products offered in this catalog covers the full spectrum of typical gage installation requirements.

Making accurate and reliable strain gage measurements does not depend on the quality of the strain gage alone. The gage can perform to its fullest potential only if the installation is of comparable quality. To accomplish, this requires strict adherence to the recommended installation procedure, including use of the proper accessory tools and supplies.

As shown in the accompanying diagram, there are three principal components in every strain gage installation: 1) the strain gage, 2) the tools, materials, and supplies (accessories) used in installing the gage, and 3) the techniques employed in performing the installation. The well-documented formula for making *consistently* successful strain gage installations is simple -

” select high-quality, precision strain gages.

- select professional-caliber accessories, laboratory- and field-proven for effectiveness and compatibility with the strain gages.
- pay careful attention to the installation procedures recommended by the manufacturer of the gages and accessories.

There are, as indicated by the double-ended arrows in the diagram, three sets of interface reactions - between the gage and accessories, between the gage and application techniques, and between the accessories and installation procedures.

Because technique is such an important ingredient in strain gage installation, Micro-Measurements accessories are accompanied by detailed instructions, where needed, for their proper use. The importance of attention to detail, and of precise adherence to the application instructions supplied, cannot be overemphasized when installing strain gages.

Additionally, to help ensure your success in installing strain gages, we maintain an experienced and highly trained Applications Engineering staff. Our Applications Engineers are as close as your telephone. We urge you to call them for recommendations in the strain gage/accessory selection process, installation technique, or to discuss any problems you may encounter when using our products.



**General Information and Selection Guide**

When a decision is made to conduct a strain gage test, proper selection of the appropriate accessories is most important to achieve high-quality installation of the strain gage. The chart below can be used as a guide to help in the selection process.

For your convenience in quickly locating a particular accessory, this databook is divided into sections by type of accessory (i.e., adhesives, soldering supplies, wire, etc.). In addition, the order of the sections in the catalog corresponds generally to the order of accessory use in making a strain gage installation. Thus, the first section is devoted to surface cleaning materials, the second to adhesives, and so on. Also included is information on other Micro-Measurements products that are very useful for strain gage installation and

testing. These include precision resistors, a gage installation tester, and a portable welder for installing weldable strain gages.

Each product entry includes both the product description and its stock designation. Product selection guides and recommendations are also provided where applicable.

Remember, your success in making reliable strain gage installations is important to us. Whenever you encounter any difficulty in the installation process, or are unsure of selecting the proper accessories for a given application, call, fax, or email our Applications Engineering Department for assistance.

<b>PLANNING FOR RELIABLE STRAIN GAGE INSTALLATIONS</b>	
<b>SEQUENCE</b>	<b>RELEVANT QUESTIONS AND CONSIDERATIONS</b>
DEFINE THE TEST CONDITIONS	Static or dynamic? Operating temperature range? Environment? Test duration? Measurement accuracy? Material properties of test part? Type of stress field and strain gradient?
SELECT THE STRAIN GAGE	Consult Tech Note TN-505, "Strain Gage Selection—Criteria, Procedures, Recommendations" and Catalog 500, "Precision Strain Gages".
SELECT THE SURFACE CLEANING SUPPLIES	Type of material and surface conditions of test part? Preparation time? Mechanical tools required? Limitations on material removal?
SELECT THE ADHESIVE	Compatibility with gage backing and test part material? Temperature (installing and test)? Fatigue life? Elongation capabilities? Strain levels expected? Clamping accessibility?
SELECT THE INSTALLATION TOOLS	Room-temperature or elevated-temperature installation? Gage location accessibility? Protective coating requirements?
SELECT THE TERMINALS	Leadwire system to be employed? Backing material? Size?
SELECT THE SOLDER & LEADWIRE	Temperature (installing and test)? Mechanical strength? Gage factor desensitization? Bridge configuration? Corrosion? Electrostatic/Electromagnetic fields?
SELECT THE PROTECTIVE COATING	Environmental survival: Temperature range, mechanical abrasion, chemical attack, pressure, etc., and ability to cure in installation environment? Reinforcement?
PROCEED WITH THE INSTALLATION	









# Surface Cleaning Supplies

## Contents

### Solvent Cleaners

CSM-2.....	14
GC-6 .....	14

### Water-Based Cleaners

MCA-1.....	15
MCA-2.....	15
MN5A-1.....	15
MN5A-2.....	15

### Surface Abrasion Materials

SCP-1 .....	15
SCP-2 .....	15
SCP-3.....	15
GC-5 .....	15

### Special Purpose Materials

TEC-1 .....	15
CSP-1 .....	15
GSP-1 .....	15

## General Information and Selection



### MATERIALS LIST

- Solvent Cleaners
- Water-Based Cleaners
- Surface-Abrasion Materials
- Special-Purpose Materials



**RoHS**  
COMPLIANT

For proper bonding of strain gages and temperature sensors, the workpiece surface must be chemically clean and totally free of contaminants before applying the adhesive. Recommended surface cleaning procedures for all common structural materials are described in Application Note B-129, "Surface Preparation for Strain Gage Bonding".

In the case of steel and aluminum parts with finish-machined or formed surfaces, the surface cleaning procedure can be summarized briefly as follows:

1. Removal of oily contaminants with a solvent cleaner.  
Note: Immersion of the workpiece in a degreaser is, by itself, inadequate; and, if done as a preliminary step, must be followed by cleaning with an uncontaminated solvent (one which is never returned to the container or otherwise reapplied after contact with the workpiece).

2. Light abrasion in the presence of a mildly acidic wash, to dislodge and remove oxides and mechanically bound contaminants.
3. Thorough surface scrubbing with an alkaline solution, to finish the cleaning process and leave the surface at the appropriate pH level for optimum bonding.

When the cleaning procedure is performed strictly according to the instructions in Application Note B-129, and when the proper high-quality cleaning agents are used, the surface will be left in a condition best suited for bonding.

Following is a complete assortment of cleaning supplies, selected specifically for surface preparation in the installation of strain gages and bondable temperature sensors.

### SOLVENT CLEANERS

#### CSM-2 Degreaser:

A powerful, environmentally friendly degreaser. Readily attacks general-purpose lubricating and hydraulic oils.

Non-flammable.

20-oz [0.56-kg] pressured spray can. Dispensing solvents from "one-way" containers prevents contamination buildup.

#### GC-6 Isopropyl Alcohol:

Frequently used as a solvent degreaser where chlorinated solutions are restricted, such as with most plastics. Flammable. 4-oz [120-ml] bottle.

## General Information and Selection

### WATER-BASED CLEANERS

Final surface preparation for most materials is accomplished with M-Prep Conditioner A immediately followed by M-Prep Neutralizer 5A.

**Conditioner A:**

A mild phosphoric-acid compound. Acts as a mild etchant and accelerates the cleaning process.

**MCA-1:** 2-oz\* [60-ml] plastic squeeze bottle with on/off dispenser nozzle cap.

**MCA-2:** 16-oz [0.5-l] plastic squeeze bottle with on/off dispenser nozzle cap.

**Shelf Life:** 1 year at +75°F [+24°C].

**Neutralizer 5A:**

An ammonia-based material. Neutralizes any chemical reaction introduced by the Conditioner A, and produces optimum surface conditions for most strain gage adhesives.

**MN5A-1:** 2-oz\* [60-ml] plastic squeeze bottle with on/off dispenser nozzle bottle cap.

**MN5A-2:** 16-oz [0.5-l] plastic squeeze bottle with on/off dispenser nozzle cap.

**Shelf Life:** 1 year at +75°F [+24°C].

\*Note: The 2-oz [60-ml] size is recommended for bench use and is easily refilled from the 16-oz [0.5-l] bottle.

### SURFACE-ABRASION MATERIALS

Abrading is often necessary to dislodge contaminants and to remove rust, scale, etc. When grit-blasting is necessary, use fine alumina powder and high-quality filters, and never recycle used grit. In general, wet-or-dry silicon-carbide paper is most convenient.

**Wet-or-Dry Silicon-Carbide Paper:**

**SCP-1 220-grit:** Suited to most steels. 1-in-x-100-ft [25-mm-x-30-m] roll.

**SCP-2 320-grit:** Suited to most steels. Also suited to aluminum alloys and other soft metals. 1-in-x-100-ft [25-mm-x-30-m] roll.

**SCP-3 400-grit:** Suited to aluminum alloys and other soft metals. 1-in-x-100-ft [25-mm-x-30-m] roll.

**GC-5 Pumice Powder:** Produces a dull, matte finish. Recommended for minimal removal of surface material. 1/2 oz [15-ml] bottle.

### SPECIAL-PURPOSE MATERIALS

**TEC-1 Tetra-Etch® Compound:**

Used for etching Teflon® to render the surface bondable. Shelf life 3 months at +32°F [0°C]. 2-oz [60-ml] can.

**CSP-1 Cotton Swabs:**

100 single-ended applicators per package (6-in [150-mm] long, wooden stick).

**GSP-1 Gauze Sponges:**

200 3-x-3-in [75-x-75-mm] sponges per package.

TetraEtch is a Registered Trademark of W. L. Gore.  
Teflon is a Registered Trademark of DuPont.





# Strain Gage Adhesives

## Contents

General Information and Selection Guide.....	18
--	----

### General-Purpose Adhesives

M-Bond 200 .....	20
M-Bond AE-10 .....	21
M-Bond AE-15.....	22
M-Bond 610 .....	23
M-Bond 600 .....	24
M-Bond 43-B.....	25

### Special-Purpose Adhesives

M-Bond GA-61 .....	26
M-Bond GA-2.....	27
M-Bond A-12.....	28
M-Bond 300 .....	29
M-Bond 450 .....	30
Denex #3 .....	31
EpoxyLite 813 .....	32
GC Cement.....	33
H Cement.....	34
P Adhesive.....	35
PBX Cement .....	36
Sauereisen DKS-8.....	37
RTC Epoxy .....	38
EPY-500 .....	39
QA-500 .....	40

## General Information and Selection Guide

Because a strain gage can perform no better than the adhesive with which it is bonded to the test member, the adhesive is a vitally important component in every strain gage installation. Although there is no single adhesive ideally suited to all applications, Micro-Measurements offers a wide selection of adhesives to cover the spectrum of stress analysis testing, and for use in transducer manufacturing. Micro-Measurements adhesives are specially formulated and selected for highest performance under the recommended environmental conditions, and are packaged to provide for ease of mixing and application.

Each adhesive is accompanied by specific instructions for its proper handling — storage, mixing, application, curing, and, if appropriate, post-curing. The adhesive containers are also dated to assure freshness of the contents.

**Note:** It is usually misguided economy to attempt installing strain gages with outdated adhesive, or adhesive that has not been stored as recommended. It should also be noted that conventional industrial and consumer adhesives are not generally suitable for bonding strain gages.

Since different adhesives are intended for different types of applications and different environmental conditions, it is obviously important to select the most appropriate adhesive for each strain measurement task. The table below lists all of the Micro-Measurements adhesives, while the table on the following page is provided as a guide for selecting the most appropriate adhesive for compatibility with a particular strain gage series and test environment.

<b>TYPES AND FEATURES</b>	
<b>M-Bond 200</b>	Most widely used general-purpose adhesive. Easiest to handle. Fast room-temperature curing.
<b>M-Bond AE-10</b>	General-purpose adhesive that is highly resistant to moisture and most chemicals. Room-temperature curing.
<b>M-Bond AE-15</b>	Similar to AE-10. Recommended for more critical applications, including transducer gaging. Moderately elevated-temperature curing.
<b>M-Bond 610</b>	Used primarily in stress analysis applications over a wide temperature range, and in precision transducers. Elevated-temperature curing.
<b>M-Bond 600</b>	Similar to 610, but faster reacting. Can be cured at somewhat lower temperatures than 610.
<b>M-Bond 43-B</b>	Normally used in precision transducers. Highly resistant to moisture and chemical attack. Elevated-temperature curing.
<b>M-Bond GA-2</b>	Special-purpose adhesive primarily used on very rough and irregular surfaces. Room-temperature curing.
<b>M-Bond GA-61</b>	Special-purpose adhesive with a higher operating temperature range than GA-2, and more viscous. Also used to fill irregular surfaces and to anchor leadwires. Elevated-temperature curing.
<b>M-Bond A-12</b>	Special-purpose, very high-elongation adhesive. Used only when other adhesives cannot meet elongation requirements. Elevated-temperature curing.
<b>M-Bond 300</b>	Special-purpose polyester adhesive used primarily when low-temperature curing is required. Sensitive to solvents. Not recommended as a general-purpose adhesive.
<b>M-Bond 450</b>	Special-purpose, high-performance epoxy for higher-temperature transducer applications.
<b>Denex #3 Adhesive</b>	One-part epoxy for lab and transducer work requiring minimal creep. Elevated temperature curing.
<b>EpoxyLite 813</b>	Used for long term, high temperature applications requiring a filled glue-line. Wider temperature range than GA-61.
<b>P Adhesive</b>	Single-part solvent thinned polyimide adhesive. Excellent for long-term high temperature applications.
<b>GC Cement</b>	Single-part ceramic cement used for free-filament gages. Recommended for use on low TCE materials, such as carbon.
<b>H Cement</b>	One-part ceramic cement/coating used for free filament strain gages. Good adhesion to most metals.
<b>PBX Cement</b>	Two-part ceramic cement/coating used for free-filament strain gages. Good adhesion to most metals.
<b>Sauereisen #8 Cement</b>	Single-part chemical setting zircon-based cement used for free-filament strain gages. High electrical insulation and thermal conductivity.

## General Information and Selection Guide

The two most important considerations for proper adhesive selection are compatibility with the backing material of the strain gage, and the operating temperature range over which the bond is expected to perform.

The chart below defines the recommended adhesive(s) for use with a particular strain gage series over various operating temperature ranges. When more than one adhesive is listed for a particular gage/test condition, preference would be given to the adhesive that is easiest to apply while still meeting all of the other performance criteria.

In addition to the primary adhesive selection criteria presented here, other factors (such as test duration, cyclic endurance required, and accuracy required) may have to be considered in the test profile. Detailed selection criteria are addressed in Tech Note TN-505, "Strain Gage Selection — Criteria, Procedures, Recommendations". There are many times when the interaction of test characteristics is too complex for selecting the proper adhesive from a chart with a high degree of confidence. In these cases, contact our Applications Engineering Department for recommendations.

<b>RECOMMENDED ADHESIVES/STRAIN GAGE SERIES</b>			
<b>TYPE OF TEST OR APPLICATION</b>	<b>OPERATING TEMPERATURE RANGE</b>	<b>GAGE SERIES</b>	<b>M-BOND ADHESIVE</b>
General Static or Static-Dynamic Stress Analysis	-50° to +150°F [-45° to +65°C]	CEA, EA	200 or AE-10 or AE-15
		WA, SA, WK, SK	AE-15 or 610
	-50° to +400°F [-45° to +205°C]	WA, SA, WK, SK	600 or 610
	-452° to +450°F [-269° to +230°C]	WK, SK	610
	<600°F [<315°C]	WK	610
High Elongation (Post-Yield)	-50° to +150°F [-45° to +65°C]	CEA, EA	200 or AE-10
		EP	AE-15 or A-12
Dynamic (Cyclic) Stress Analysis	-100° to +150°F [-75° to +65°C]	ED	200 or AE-10
	-320° to +500°F [-195° to +260°C]	WD	AE-10 or AE-15
Transducer Gaging	-50° to +150°F [-45° to +65°C]	CEA, EA	AE-10 or AE-15
	-50° to +200°F [-45° to +95°C]	N2A, J2A	600 or 610 or 43-B
	-50° to +300°F [-45° to +150°C]	WA, SA, TA, TK, J5K	610, 450, P Adhesive
	-320° to +350°F [-195° to +175°C]	WK, SK, TK, J5K	610, 450, P Adhesive
High Temperature Gaging	-452° to +700°F [-269° to +370°C]	WK, RK	P Adhesive
	-320° to +1600°F [-195° to +870°C]	ZC	H Cement

### Strain Gage Adhesive



#### OTHER ACCESSORIES USED IN AN M-BOND 200 INSTALLATION:

- CSM Degreaser or GC-6 Isopropyl Alcohol
- Silicon Carbide Paper
- M-Prep Conditioner A
- M-Prep Neutralizer 5A
- GSP-1 Gauze Sponges
- CSP-1 Cotton Applicators
- PCT-2M Gage Installation Tape



RoHS  
COMPLIANT

#### DESCRIPTION

For routine experimental stress analysis applications under temperate environmental conditions, M-Bond 200 adhesive is ordinarily the best choice. This adhesive is very easy to handle, and cures almost instantly to produce an essentially creep-free, fatigue-resistant bond, with elongation capability of five percent or more.

M-Bond 200 is a cyanoacrylate that has been pretested and certified for use in bonding strain gages. It is an excellent general-purpose adhesive for laboratory and short-term field applications. The procedure for making a strain gage installation with M-Bond 200 is illustrated and described in detail in Instruction Bulletin B-127 included in each kit of adhesive.

The user should note that the performance of the adhesive can be degraded by the effects of time, humidity conditions, elevated temperature, and moisture absorption. Because of the latter effect, strain gage installations should always be covered with a suitable protective coating. When necessitated by more rigorous test requirements and/or environmental conditions, consideration should be given to one of the M-Bond epoxy adhesives, using the "Recommended Adhesives/Strain Gage Series" chart.

#### CHARACTERISTICS

##### Cure Requirements:

One-minute thumb pressure, followed by a minimum two-minute delay before tape removal. Bond strength increases rapidly during first five minutes. Cure time must be extended under conditions of low temperature (<70°F [ $<21^{\circ}\text{C}$ ]) or low humidity (<40% RH).

##### Operating Temperature Range:

**Short Term:**  $-300^{\circ}$  to  $+200^{\circ}\text{F}$  [ $-185^{\circ}$  to  $+95^{\circ}\text{C}$ ].

**Long Term:**  $-25^{\circ}$  to  $+150^{\circ}\text{F}$  [ $-32^{\circ}$  to  $+65^{\circ}\text{C}$ ].

##### Elongation Capabilities:

>5% at  $+75^{\circ}\text{F}$  [ $+24^{\circ}\text{C}$ ], 3% at  $+75^{\circ}\text{F}$  [ $+24^{\circ}\text{C}$ ] when used with CEA or EA/Option E strain gages.

##### Shelf Life:

Minimum 3 months at  $+75^{\circ}\text{F}$  [ $+24^{\circ}\text{C}$ ] after opening, with cap replaced immediately after each use. Shelf life refers to the duration of time, beginning on date of shipment, over which properly stored adhesive should be expected to meet published specifications.

**Note:** To ensure a proper seal, wipe bottle spout clean and dry before replacing cap.

May be stored unopened up to 3 months at  $+75^{\circ}\text{F}$  [ $+24^{\circ}\text{C}$ ] or 6 months at  $+40^{\circ}\text{F}$  [ $+5^{\circ}\text{C}$ ].

**Note:** Condensation rapidly degrades adhesive performance and shelf life; after refrigeration, allow adhesive to reach room-temperature before opening. Refrigeration after opening is not recommended.

#### PACKAGING OPTIONS

##### Kit:

1 bottle [1 oz/28g] Adhesive  
1 brush-cap bottle [30ml] Catalyst  
polyethylene dispenser cap

##### Bulk:

Adhesive — 1 bottle [1oz/28g]  
Adhesive — 5 tubes [2g each]  
Adhesive — 16 bottles [1oz/28g each]  
Catalyst — 12 brush-cap bottles [30ml each]



## Strain Gage Adhesive



### OTHER ACCESSORIES USED IN AN M-BOND AE-10 INSTALLATION:

- CSM Degreaser or GC-6 Isopropyl Alcohol
- Silicon-Carbide Paper
- M-Prep Conditioner A
- M-Prep Neutralizer 5A
- GSP-1 Gauze Sponges
- CSP-1 Cotton Applicators
- PCT-2M Gage Installation Tape
- HSC Spring Clamp
- GT-14 Pressure Pads and Backup Plates



**RoHS**  
COMPLIANT

### DESCRIPTION

Two-component, 100%-solids epoxy system for general-purpose stress analysis. Transparent, medium viscosity. Cure time as low as six hours at +75°F [+24°C] may be used. Elevated-temperature postcure is recommended for maximum stability, and/or tests above room temperature.

Highly resistant to moisture and most chemicals, particularly when postcured. For maximum elongation, bonding surface must be roughened. Cryogenic applications require very thin glue-lines.

### CHARACTERISTICS

#### Operating Temperature Range:

**Long Term:** -320° to +200°F [-195° to +95°C].

#### Elongation Capabilities:

1% at -320°F [-195°C];  
6% to 10% at +75°F [+24°C];  
15% at +200°F [+95°C].

#### Shelf Life:

Minimum 12 months at +75°F [+24°C]; or 18 months at +40°F [+5°C]. If crystals form in resin jar, heat to +120°F [+50°C] for 30 minutes. Cool before mixing.

#### Pot Life:

15 to 20 minutes at +75°F [+24°C]. Can be extended by cooling jar or by spreading adhesive on clean aluminum plate.

#### Clamping Pressure:

5 to 20psi [35 to 140kN/m<sup>2</sup>].

#### Cure Requirements:

**Preferred Room-Temperature Cure:** 24-48 hours at +75°F [+24°C].

**Recommended Postcure:** 2 hours at 25°F [15°C] above maximum operating temperature.

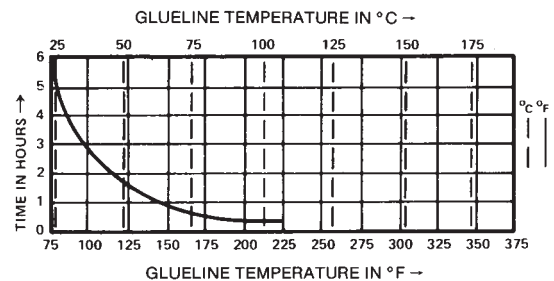

### PACKAGING

#### Kit:

6 mixing jars [10g ea] Resin  
1 bottle [15ml] Curing Agent 10  
6 calibrated pipettes  
6 stirring rods

#### Bulk:

200g Resin  
40g Curing Agent 10  
3 calibrated pipettes

**References:** Instruction Bulletin B-137, "Strain Gage Applications with M-Bond AE-10, AE-15, and GA-2 Adhesive Systems", included in each kit.

### Strain Gage Adhesive



#### OTHER ACCESSORIES USED IN AN M-BOND AE-15 INSTALLATION:

- CSM Degreaser or GC-6 Isopropyl Alcohol
- Silicon-Carbide Paper
- M-Prep Conditioner A
- M-Prep Neutralizer 5A
- GSP-1 Gauze Sponges
- CSP-1 Cotton Applicators
- PCT-2M Gage Installation Tape
- HSC Spring Clamp
- GT-14 Pressure Pads and Backup Plates



RoHS  
COMPLIANT

#### DESCRIPTION

Two-component, 100%-solids epoxy system for general-purpose stress analysis. Transparent, medium viscosity. Cure time as low as six hours at +125°F [+50°C]. Recommended for more critical applications, including transducers. It has a longer pot life than M-Bond AE-10 which allows more time for multiple gage installations.

Elevated-temperature postcure is recommended for maximum stability, and/or tests above room temperature. Highly resistant to moisture and most chemicals, particularly when postcured. For maximum elongation, bonding surface must be roughened. Cryogenic applications require very thin gluelines.

#### CHARACTERISTICS

##### Operating Temperature Range:

**Long Term:** -452° to +200°F [-269° to +95°C].

**Transducers:** to +175°F [+80°C].

##### Elongation Capabilities:

2% at -320°F [-195°C];

10% to 15% at +75°F [+24°C];

15% at +200°F [+95°C].

##### Shelf Life:

Minimum 12 months at +75°F [+24°C]; or 18 months at +40°F [+5°C]. If crystals form in resin jar, heat to +120°F [+50°C] for 30 minutes. Cool before mixing.

##### Pot Life:

1-1/2 hours at +75°F [+24°C].

##### Clamping Pressure:

5 to 20psi [35 to 140kN/m<sup>2</sup>].

##### Cure Requirements:

**Recommended PostCure:** 2 hours at 25°F [15°C] above maximum operating temperature.

**Optimum Performance Transducer Postcure:**

1 hour at +200°F [+95°C].

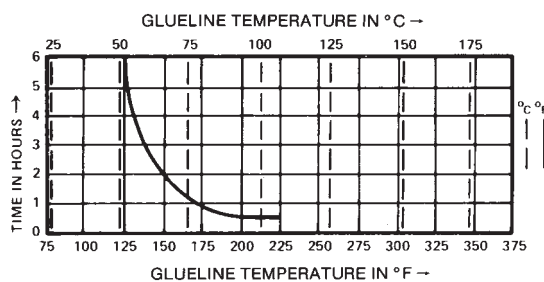

#### PACKAGING OPTIONS

##### Kit:

- 6 mixing jars [10g ea] Resin
- 1 bottle [15ml] Curing Agent 15
- 6 calibrated pipettes
- 6 stirring rods

##### Bulk:

- 200g Resin
- 25g Curing Agent 15
- 3 calibrated pipettes

##### References:

Instruction Bulletin B-137, "Strain Gage Applications with M-Bond AE-10, AE-15, and GA-2 Adhesive Systems", included in each kit.

## Strain Gage Adhesive



### OTHER ACCESSORIES USED IN AN M-BOND 610 INSTALLATION:

- CSM Degreaser or GC-6 Isopropyl Alcohol
- Silicon-Carbide Paper
- M-Prep Conditioner A
- M-Prep Neutralizer 5A
- GSP-1 Gauze Sponges
- CSP-1 Cotton Applicators
- MJG-2 Mylar® Tape
- TFE-1 Teflon® Film
- HSC Spring Clamp
- GT-14 Pressure Pads and Backup Plates



**RoHS**  
COMPLIANT

### DESCRIPTION

Two-component, solvent-thinned, epoxy-phenolic adhesive for high-performance applications, including high-precision transducers. Solids content 22%. Widest temperature range general-purpose adhesive available. Low viscosity, capable

of gluelines <0.0002 in [0.005mm]. Extremely thin, hard, void-free gluelines minimize creep, hysteresis, and linearity problems. Cure must begin within four hours of application.

### CHARACTERISTICS

#### Operating Temperature Range:

**Short Term:** -452° to +700°F [-269° to +370°C].

**Long Term:** -452° to +500°F [-269° to +260°C].

**Transducers:** to +450°F [+230°C].

#### Elongation Capabilities:

1% at -452°F [-269°C];

3% at +75°F [+24°C];

3% at +500°F [+260°C].

#### Shelf Life:

Minimum 9 months at +75°F [+24°C]; or 15 months at +40°F [+5°C].

#### Pot Life:

6 weeks at +75°F [+24°C]; 12 weeks at +40°F [+5°C].

#### Clamping Pressure:

10 to 70psi [70 to 480kN/m<sup>2</sup>].

30 to 40psi optimum [200 to 275kN/m<sup>2</sup>].

#### Cure Requirements:

**Recommended Postcure:** 2 hours at 50° to 75°F [30° to 40°C] above maximum operating temperature or cure temperature, whichever is higher.

**High Precision Transducer Postcure:** 2 hours at +400° to +450°F [+205° to +230°C] after wiring.

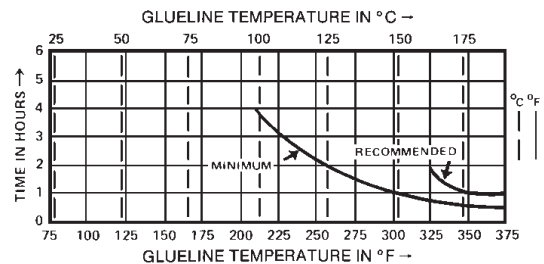

### PACKAGING OPTIONS

#### Kit:

4 bottles [11g ea] Curing Agent

4 bottles [14g ea] Resin

4 brush caps for dispensing mixed adhesive

4 disposable mixing funnels

#### Single Mix Kit:

1 bottle [11g ea] Curing Agent

1 bottle [14g ea] Resin

1 brush cap for dispensing mixed adhesive

1 disposable mixing funnel

#### References:

Instruction Bulletin B-130, "Strain Gage Installations with M-Bond 43-B, 600 and 610 Adhesive Systems," included in each kit.

Mylar and Teflon are Registered Trademarks of DuPont

### Strain Gage Adhesive



#### OTHER ACCESSORIES USED IN AN M-BOND 600 INSTALLATION:

- CSM Degreaser or GC-6 Isopropyl Alcohol
- Silicon-Carbide Paper
- M-Prep Conditioner A
- M-Prep Neutralizer 5A
- GSP-1 Gauze Sponges
- CSP-1 Cotton Applicators
- MJG-2 Mylar® Tape
- TFE-1 Teflon® Film
- HSC Spring Clamp
- GT-14 Pressure Pads and Backup Plates



RoHS  
COMPLIANT

#### DESCRIPTION

Similar to M-Bond 610 except with more reactive curing agent. Shorter shelf life, pot life, and working time than M-Bond 610, but has lower temperature cures and faster

reaction time. Cure must begin within 30 minutes of application (up to 4 hours for M-Bond 610).

#### CHARACTERISTICS

##### Operating Temperature Range:

**Short Term:** -452° to +700°F [-269° to +370°C].

**Long Term:** -452° to +500°F [-269° to +260°C].

##### Elongation Capabilities:

1% at -452°F [-269°C];

3% at +75°F [+24°C];

3% at +500°F [+260°C].

##### Shelf Life:

Minimum 3 months at +75°F [+24°C]; or 9 months at +40°F [+5°C].

##### Pot Life:

2 weeks at +75°F [+24°C]; 4 weeks at +40°F [+5°C].

##### Clamping Pressure:

10 to 70psi [70 to 480kN/m<sup>2</sup>].

30 to 40psi optimum [200 to 275kN/m<sup>2</sup>].

##### Cure Requirements:

**Moderately Elevated-Temperature Cure Required.**

**Recommended Postcure:**

1 to 2 hours at 50°F [30°C] above maximum operating temperature.

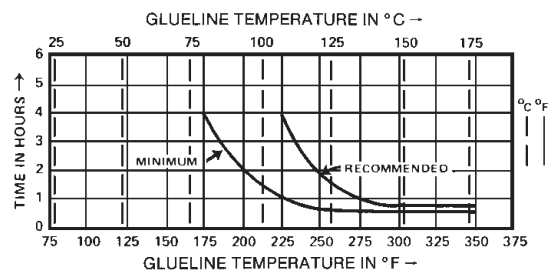

#### PACKAGING

##### Kit:

- 4 bottles [11g ea] Curing Agent
- 4 bottles [8g ea] Resin
- 4 brush caps for dispensing mixed adhesive
- 4 disposable mixing funnels

##### Single Mix Kit:

- 1 bottle [11g ea] Curing Agent
- 1 bottle [8g ea] Resin
- 1 brush cap for dispensing mixed adhesive
- 1 disposable mixing funnel

##### References:

Instruction Bulletin B-130, "Strain Gage Installations with M-Bond 43-B, 600 and 610 Adhesive Systems" included in each kit.

Mylar and Teflon are Registered Trademarks of DuPont

## Strain Gage Adhesive



### OTHER ACCESSORIES USED IN AN M-BOND 43-B INSTALLATION:

- CSM Degreaser or GC-6 Isopropyl Alcohol
- Silicon-Carbide Paper
- M-Prep Conditioner A
- M-Prep Neutralizer 5A
- GSP-1 Gauze Sponges
- CSP-1 Cotton Applicators
- MJG-2 Mylar® Tape
- TFE-1 Teflon® Film
- HSC Spring Clamp
- GT-14 Pressure Pads and Backup Plates



**RoHS**  
COMPLIANT

### DESCRIPTION

Single-component, solvent-thinned, epoxy adhesive normally used in transducer applications; solids content 25%. May be used both as an adhesive and as a protective

coating. Capable of forming very thin, hard, void-free gluelines similar to M-Bond 610. Highly resistant to moisture and chemical attack.

### CHARACTERISTICS

#### Operating Temperature Range:

**Short Term:** -452° to +350°F [-269° to +175°C].

**Long Term:** -452° to +300°F [-269° to +150°C].

**Transducers:** to +250°F [+120°C].

#### Elongation Capabilities:

1% at -452°F [-269°C];

4% at +75°F [+24°C];

2% at +300°F [+150°C].

#### Shelf Life:

Minimum 9 months at +75°F [+24°C]; or 18 months at +40°F [+5°C].

#### Pot Life:

Minimum 9 months at +75°F [+24°C]; or 18 months at +40°F [+5°C].

#### Clamping Pressure:

15 to 100psi [100 to 700kN/m<sup>2</sup>].

40 to 50psi [275 to 350kN/m<sup>2</sup>] optimum.

#### Cure Requirements:

**Recommended:** 2 hours at +375°F [+190°C], or as an alternate cure for aluminum alloy transducers, 2 1/2 hours at +300°F [+150°C]

**Recommended Transducer Postcure:** 2 hours at +400°F [+205°C], or as an alternate postcure for aluminum alloy transducers 2 1/2 hours at +350°F [+175°C].

### PACKAGING

#### Kit:

4 brush-cap bottles [30ml ea] premixed adhesive

#### Single Bottle:

1 brush cap bottle [30ml] premixed adhesive

#### References:

Instruction Bulletin B-130, "Strain Gage Installations with M-Bond 43-B, 600 and 610 Adhesive Systems", included in each kit.

Mylar and Teflon are Registered Trademarks of DuPont

## Strain Gage Adhesive



### OTHER ACCESSORIES USED IN AN M-BOND GA-61 INSTALLATION:

- CSM Degreaser or GC-6 Isopropyl Alcohol
- Silicon-Carbide Paper
- M-Prep Conditioner A
- M-Prep Neutralizer 5A
- GSP-1 Gauze Sponges
- CSP-1 Cotton Applicators
- MJG-2 Mylar® Tape
- TFE-1 Teflon® Film
- HSC Spring Clamp
- GT-14 Pressure Pads and Backup Plates



**RoHS**  
COMPLIANT

### DESCRIPTION

Two-component, partially filled, 100%-solids epoxy adhesive for general-purpose stress analysis. Very high viscosity. Widely used to fill irregular surfaces and to anchor leadwires.

Forms a very hard, chemical-resistant material when fully cured. Glueline thickness is generally <0.002 in [0.05mm].

### CHARACTERISTICS

#### Operating Temperature Range:

**Short Term:** -100° to +600°F [-75° to +315°C].

**Long Term:** -100° to +500°F [-75° to +260°C].

#### Elongation Capabilities:

1% at -100°F [-75°C];

2% at +75°F [+24°C];

1% at +500°F [+260°C].

#### Shelf Life:

6 months minimum at +75°F [+24°C]; refrigeration recommended.

#### Pot Life:

10 hours at +75°F [+24°C]; increased by refrigeration, indefinite by freezing.

#### Clamping Pressure:

10 to 30psi [70 to 200kN/m<sup>2</sup>].

#### Cure Requirements:

**Elevated-Temperature Cure Required.**

**Recommended Postcure:** 1 hour at 50°F [30°C] above maximum operating temperature not to exceed +600°F [+315°C].

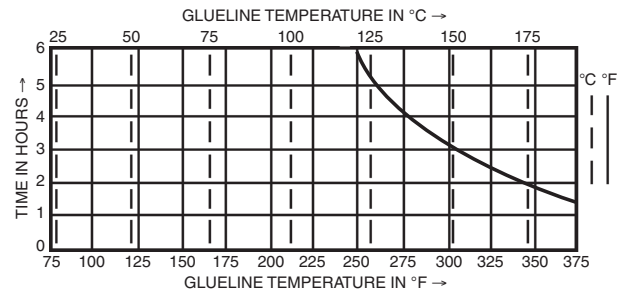

### PACKAGING

#### Kit:

3 jars [10g ea] Resin

3 jars [5g ea] Hardener

3 stirring rods

**References:** Instruction Bulletin B-128, "Strain Gage Applications with M-Bond GA-61 Adhesive", included in each kit.

Mylar and Teflon are Registered Trademarks of DuPont

## Strain Gage Adhesive



### OTHER ACCESSORIES USED IN AN M-BOND GA-2 INSTALLATION:

- CSM Degreaser or GC-6 Isopropyl Alcohol
- Silicon-Carbide Paper
- M-Prep Conditioner A
- M-Prep Neutralizer 5A
- GSP-1 Gauze Sponges
- CSP-1 Cotton Applicators
- PCT-2M Gage Installation Tape
- HSC Spring Clamp
- GT-14 Pressure Pads and Backup Plates



RoHS  
COMPLIANT

### DESCRIPTION

Two-component, partially filled, 100%-solids epoxy system for general-purpose stress analysis. Higher viscosity than AE systems. Elevated-temperature cure recommended for best

performance and resistance to chemical attack. Often used to fill irregular surfaces. Uneven gluelines easily detectable by nonuniformity of bond color.

### CHARACTERISTICS

#### Operating Temperature Range:

**Long Term:** -320° to +200°F [-195° to +95°C].

#### Elongation Capabilities:

4% at -320°F [-195°C].

10% to 15% at +75°F [+24°C] after 40-hour RT cure or 6-hour RT cure with postcure.

#### Shelf Life:

Minimum 12 months at +75°F [+24°C]; or 18 months at +40°F [+5°C].

#### Pot Life:

15 minutes at +75°F [+24°C]. Can be extended by cooling jar or by spreading adhesive on clean aluminum plate.

#### Clamping Pressure:

5 to 20psi [35 to 140kN/m<sup>2</sup>]. The black filler provides a visual indication of nonuniform bond areas caused by uneven clamping pressure.

#### Cure Requirements:

**Preferred Room-Temperature Cure:** 40 hours at +75°F [+24°C].

**Recommended Postcure:** 2 hours at 25°F [15°C] above maximum operating temperature.

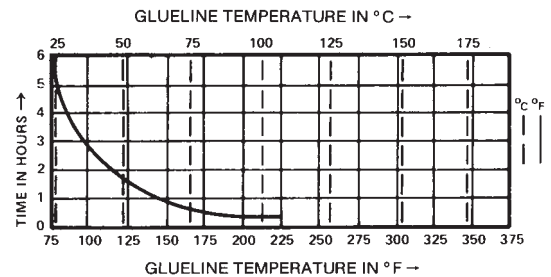

### PACKAGING

#### Kit:

- 6 mixing jars [15g ea] Resin
- 6 calibrated pipettes
- 1 bottle [15ml] Curing Agent 10-A
- 6 stirring rods

**References:** Instruction Bulletin B-137, "Strain Gage Applications with M-Bond AE-10, AE-15, and GA-2 Adhesive Systems," included in each kit.

### Strain Gage Adhesive

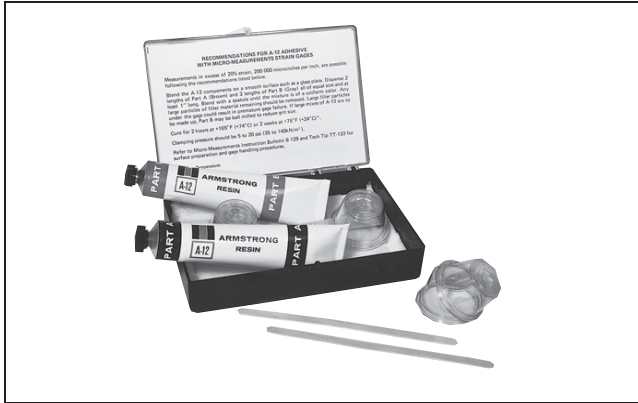

#### OTHER ACCESSORIES USED IN AN M-BOND A-12 INSTALLATION:

- CSM Degreaser or GC-6 Isopropyl Alcohol
- Silicon-Carbide Paper
- M-Prep Conditioner A
- M-Prep Neutralizer 5A
- GSP-1 Gauze Sponges
- CSP-1 Cotton Applicators
- PCT-2M Gage Installation Tape
- HSC Spring Clamp
- GT-14 Pressure Pads and Backup Plates



RoHS  
COMPLIANT

#### DESCRIPTION

Two-component, 100%-solids epoxy system. Not intended as a general-purpose strain gage adhesive. Should be used only when maximum elongation requirements of a test

exceed the capabilities of other M-Bond adhesive systems. Mixed adhesive gritty with large solid particles present; large particles must be removed prior to gage installation.

#### CHARACTERISTICS

##### Operating Temperature Range:

**Long Term:** -50° to +180°F [-45° to +80°C].

##### Elongation Capabilities:

15% to 20% at +75°F [+24°C].

##### Shelf Life:

Minimum 1 year at +75°F [+24°C].

##### Pot Life:

Approximately 1 hour.

##### Clamping Pressure:

5 to 20psi [35 to 140kN/m<sup>2</sup>].

##### Cure Requirements:

2 hours at +165°F [+75°C] or 2 weeks at +75°F [+24°C].

#### PACKAGING

##### Kit:

- 1 tube each Part A and Part B
- 5 disposable mixing cups
- 5 wooden stirring sticks

**References:** Application instructions for M-Bond A-12 are included in each kit.



## Strain Gage Adhesive



### OTHER ACCESSORIES USED IN AN M-BOND 300 INSTALLATION:

- CSM Degreaser or GC-6 Isopropyl Alcohol
- Silicon-Carbide Paper
- M-Prep Conditioner A
- M-Prep Neutralizer 5A
- GSP-1 Gauze Sponges
- CSP-1 Cotton Applicators
- PCT-2M Gage Installation Tape
- HSC Spring Clamp
- GT-14 Pressure Pads and Backup Plates



**RoHS**  
COMPLIANT

### DESCRIPTION

Special-purpose, two-component polyester adhesive. Not recommended as a general-purpose strain gage adhesive, but useful when a low-temperature-curing adhesive is required. While possessing the high shear strength required

of a strain gage adhesive, peel strength and solvent sensitivity are relatively poor. Should not be used for impact strain measurements, or with solvent-thinned protective coatings.

### CHARACTERISTICS

#### Operating Temperature Range:

**Long Term:** -40° to +300°F [-40° to +150°C].

#### Elongation Capabilities:

1% to 2% at +75°F [+24°C].

#### Shelf Life:

Minimum 4 months at +75°F [+24°C].

#### Pot Life:

15 to 20 minutes at +40°F [+5°C]; 5 to 8 minutes at +75°F [+24°C].

#### Clamping Pressure:

5 to 20psi [35 to 140kN/m<sup>2</sup>].

#### Cure Requirements:

24 hours at +40°F [+5°C];  
18 hours at +60°F [+15°C];  
12 hours at +75°F [+24°C].

### PACKAGING

#### Kit:

6 mixing jars [10g ea] Resin  
6 calibrated pipettes  
1 bottle [6g] Catalyst  
6 stirring rods

**References:** Instruction Bulletin B-133, "Strain Gage Installations with M-Bond 300 Adhesive", included in each kit.

## Strain Gage Adhesive

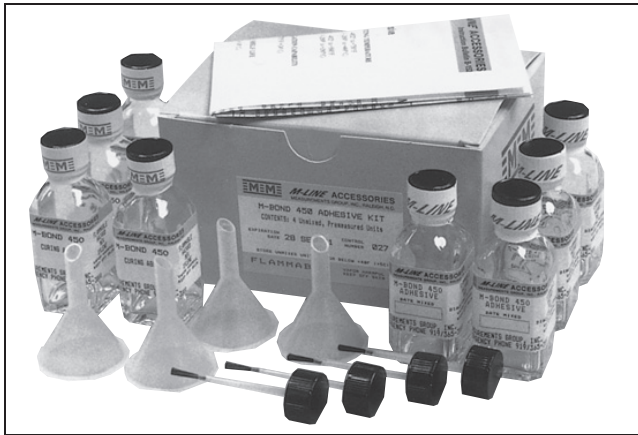

### OTHER ACCESSORIES USED IN AN M-BOND 450 INSTALLATION:

- CSM Degreaser or GC-6 Isopropyl Alcohol
- Silicon-Carbide Paper
- M-Prep Conditioner A
- M-Prep Neutralizer 5A
- GSP-1 Gauze Sponges
- CSP-1 Cotton Applicators
- MJG-2 Mylar® Tape
- TFE-1 Teflon® Film
- HSC Spring Clamp
- GT-14 Pressure Pads and Backup Plates



**RoHS**  
COMPLIANT

### DESCRIPTION

High-performance, two-component, solvent-thinned epoxy system specially formulated for high accuracy, elevated-temperature transducer applications.

### CHARACTERISTICS

#### Operating Temperature Range:

**Short Term:** -452° to +750°F [-269° to +400°C].

**Long Term:** -452° to +500°F [-269° to +260°C].

#### Elongation Capabilities:

>5% at +75°F [+24°C].

#### Shelf Life:

Minimum 6 months at +75°F [+24°C].

#### Pot Life:

6 weeks at +75°F [+24°C].

#### Clamping Pressure:

60 to 100psi [415 to 690kN/m<sup>2</sup>].

#### Cure Requirements:

**Step 1:** Air dry at +75°F [+24°C] 10 to 30 minutes.

**B-Stage:** +225°F [+105°C] for 30 minutes.

**Cure:** +350°F [+175°C] for 1 hour.

**Recommended Postcure:** 1 hour at 50°F [30°C] above maximum operating temperature in 50°F [30°C] increments from +350°F [+175°C], dwelling 1 hour at each step.

### PACKAGING

#### Kit:

4 bottles [12.5g ea] Curing Agent

4 bottles [12.5g ea] Resin

4 brush caps for applying adhesive

4 disposable mixing funnels

**References:** Instruction Bulletin B-152, "Instructions for the Application of Micro-Measurements M-Bond 450 Adhesive", included in each kit.

Mylar and Teflon are Registered Trademarks of DuPont

## Strain Gage Adhesive

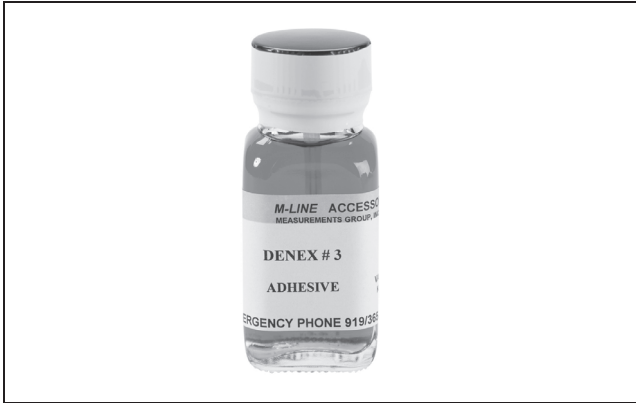

### OTHER ACCESSORIES USED IN A DENEX #3 INSTALLATION:

- CSM-1 Degreaser or GC-6 Isopropyl Alcohol
- Silicon Carbide Paper
- M-Prep Conditioner A
- M-Prep Neutralizer 5A
- MJG-2 Mylar® Tape
- TFE-1 Teflon® Film
- HSC Spring Clamp
- GT-14 Pressure Pads and Backup Plates



**RoHS**  
COMPLIANT

### DESCRIPTION

Single-component, solvent thinned epoxy adhesive used in laboratory and transducer applications where negligible creep can be tolerated. Can be solvent thinned (acetone) for

easy application. Lower creep at elevated temperatures. Can be B-staged or dried prior to clamped curing.

### CHARACTERISTICS

**Operating Temperature Range:**

−452° to +400°F [−269° to +204°C].

**Elongation Capability:**

1% at +75°F [+24°C].

**Shelf Life:**

Minimum 1 year at +75°F [+24°C].

**Pot Life:**

Minimum 1 year at +75°F [+24°C].

**Clamping Pressure:**

30-50psi [200 to 350kN/m<sup>2</sup>].

**Cure Requirements:**

**Laboratory Use:** 1 hour at +250°F [+120°C], followed by 1 hr at +350°F [+175°C].

**Transducers:** 4 hours at +325°F [+160°C].

**Postcure (Unclamped):**

**Laboratory Use:** 1 hour at 75°F [40°C] above maximum operating temperature.

**Transducers:** 4 hours at +350°F [+175°C].

### PACKAGING OPTIONS

**Kit:**

- 1 brush cap bottle [1oz/30ml] of premixed adhesive.
- 4 brush cap bottles [1oz/30ml each] premixed adhesive.
- 1 bottle [32oz/950ml] premixed adhesive.

Mylar and Teflon are Registered Trademarks of DuPont

## Strain Gage Adhesive



### OTHER ACCESSORIES USED IN AN EPOXYLITE 813 INSTALLATION:

- CSM Degreaser or GC-6 Isopropyl Alcohol
- Silicon-Carbide Paper
- M-Prep Conditioner A
- M-Prep Neutralizer 5A
- GSP-1 Gauze Sponges
- MJG-2 Mykar® Tape
- TFE-1 Teflon® Film
- HSC Spring Clamp
- GT-14 Pressure Pads and Backup Plates



**RoHS**  
COMPLIANT

### DESCRIPTION

Two-part, 100%-solids, epoxy adhesive. Similar to GA-61, but serviceable to +600°F [+315°C]. Excellent adhesion to metals, ceramics, and most composites.

### CHARACTERISTICS

**Operating Temperature Range:**

-320° to +600°F [-195° to +315°C].

**Elongation Capabilities:**

1% at +75°F [+24°C].

**Shelf Life:**

Minimum 6 months at +75°F [+24°C].

**Pot Life:**

6-8 hours at +75°F [+24°C].

**Clamping Pressure:**

30 to 70psi [200 to 350kN/m<sup>2</sup>].

**Cure Requirements:**

4 hours at +350°F [+175°C].

**Recommended Postcure (Unclamped):**

1 hour at 25°F (15°C) above maximum operating temperature.

### PACKAGING OPTIONS

**Kits:**

6 bottles Part A [0.5oz/18gm] Resin.

6 bottles Part B [0.25oz/7gm] Powder.

Mylar and Teflon are Registered Trademarks of DuPont.

## Strain Gage Cement

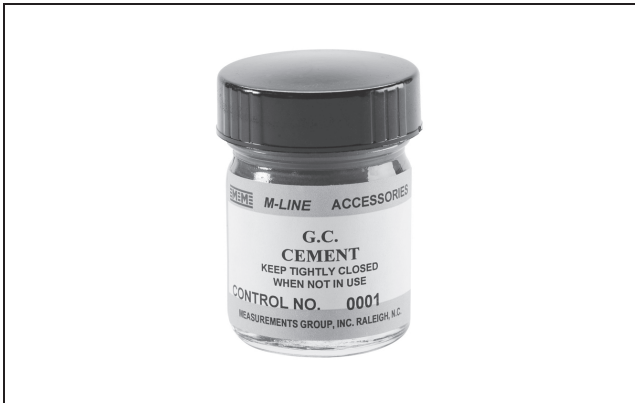

### OTHER ACCESSORIES USED IN A GC CEMENT INSTALLATION:

- CSM Degreaser or GC-6 Isopropyl Alcohol
- Silicon-Carbide Paper
- M-Prep Conditioner A
- M-Prep Neutralizer 5A
- GSP-1 Gauze Sponges
- GT-11 Camel's Hair Brush
- SPT-1 Double Blade Spatula



**RoHS**  
COMPLIANT

### DESCRIPTION

Single-part ceramic cement for bonding free-filament strain gages (wire and foil). Recommended for installations on low-TCE materials such as carbon.

### CHARACTERISTICS

**Operating Temperature Range:**

-320° to +2000°F [-195° to +1093°C].

**Elongation Capabilities:**

0.5% at +75°F [+24°C].

**Shelf Life:**

Minimum 1 year at +75°F [+24°C].

**Pot Life:**

1 year at +75°F [+24°C].

**Temperature Coefficient of Expansion:**

1.5ppm/°F [2.7ppm/°C].

**Cure Requirements:**

**Precoat:** Air-dry 30 minutes at +75°F [+24°C], then 30 minutes at +200°F [+95°C] followed by 30 minutes at +300°F [+150°C].

**Final Coat:** Air-dry 30 minutes at +75°F [+24°C], then 30 minutes at +200°F [+95°C] followed by 30 minutes at +300°F [+150°C], and final 1 hour at +600°F [+315°C].

### PACKAGING OPTIONS

**Kits:**

1 bottle [1oz/30ml] premixed.

## Strain Gage Cement



### OTHER ACCESSORIES USED IN AN H CEMENT INSTALLATION:

- CSM Degreaser or GC-6 Isopropyl Alcohol
- Silicon-Carbide Paper
- M-Prep Conditioner A
- M-Prep Neutralizer 5A
- GSP-1 Gauze Sponges
- GT-11 Camel's Hair Brush
- SPT-1 Double Blade Spatula
- H Cement Thinner

### DESCRIPTION

Single-part ceramic cement/coating. Excellent electrical-insulation properties, even at +1600°F [+870°C]. Good adhesion to most metals.

### CHARACTERISTICS

#### Operating Temperature Range:

−452° to +1600°F [−269° to +870°C].

#### Elongation Capabilities:

0.5% at +75°F [+24°C].

#### Shelf Life:

Minimum 1 year at +75°F [+24°C].

#### Pot Life:

Minimum 1 year at +75°F [+24°C].

#### Temperature Coefficient of Expansion

7.0ppm/°F [13ppm/°C].

#### Cure Requirements:

##### Precoat:

Air-dry 30 minutes at +75°F [+24°C], then 30 minutes at +200°F [95°C] followed by 30 minutes at 350°F [177°C].

##### Final Coat:

Air-dry 30 minutes at +75°F [+24°C], then 30 minutes at +200°F [95°C] followed by 30 minutes at 350°F [177°C], and final 1 hour at +600°F [+315°C].

### PACKAGING OPTIONS

#### Kits:

1 bottle [1oz/30ml] Cement

H Cement Kit A: 2 bottles [1oz/30ml] Cement

1 bottle [0.5oz/15ml] Thinner

1 bottle [2oz/60ml] Conditioner A

1 bottle [2oz/60ml] Neutralizer 5A

1 package 100-count CSP-1 Cotton Swabs

1 package 200-count GSP-1 Gauze

Sponges

12 sheets [2in x 4.5in/50mm x 115mm]

of 400-grit Silicon-Carbide Paper

H Cement Kit B: Same as H Cement Kit A except 6 bottles [1oz/30ml] Cement

## Strain Gage Adhesive



### OTHER ACCESSORIES USED IN A P ADHESIVE INSTALLATION:

- CSM Degreaser or GC-6 Isopropyl Alcohol
- Silicon-Carbide Paper
- M-Prep Conditioner A
- M-Prep Neutralizer 5A
- CSP-1 Cotton Swabs
- GSP-1 Gauze Sponges
- MJG-2 Mylar® Tape
- TFE-1 Teflon® Film
- HSC Spring Clamp
- GT-14 Pressure Pads and Backup Plates



**RoHS**  
COMPLIANT

### DESCRIPTION

Single-part, solvent-thinned, polyimide adhesive. Results in a strong, thin, near-creep-free, adhesive layer.

### CHARACTERISTICS

**Operating Temperature Range:**  
-452° to +700°F [-270° to +370°C].

**Upper limit:**  
+800°F [+425°C] for 1 to 2 hours.

**Elongation Capabilities:**  
±2% at +75°F [+24°C].

**Shelf Life:**  
Minimum 4 months at +75°F [+24°C].

**Pot Life:**  
Minimum 4 months at +75°F [+24°C].

**Clamping Pressure:**  
20 to 40psi [140 to 280kN/m<sup>2</sup>].

#### Cure Requirements:

For two minutes, expose the adhesive on the strain gage and test article to an infrared lamp or other heat source until the materials are dry. Monitor the temperature of the surface and do not allow materials to exceed +250°F [+120°C].

After clamping, cure 2 hours at +250°F [+120°C], increase temperature to +300°F [+150°C] for 2 hours, increase temperature to +340°F [+170°C] for 2 hours and finish cure with 4 hours at +380°F [+195°C].

#### Recommended Postcure (Unclamped):

1 hour at +300°F [+150°C], followed by 2 hours at +400°F [+205°C], and then 4 hours at +500°F [+260°C].

### PACKAGING OPTIONS

**Kits:**  
1 brush-cap bottle [1oz/30ml]

Mylar and Teflon are Registered Trademarks of DuPont

## Strain Gage Cement



### OTHER ACCESSORIES USED IN A PBX CEMENT INSTALLATION:

- CSM Degreaser or GC-6 Isopropyl Alcohol
- Silicon-Carbide Paper
- M-Prep Conditioner A
- M-Prep Neutralizer 5A
- GSP-1 Gauze Sponges
- GT-11 Camel's Hair Brush
- SPT-1 Double Blade Spatula

### DESCRIPTION

Two-part ceramic cement/coating with excellent electrical insulating properties up to +1200°F [+650°C]. Recommended as a high-temperature cement and coating

for free-filament strain gages (wire and foil) and thermocouple applications. Provides good adhesion to most metals.

### CHARACTERISTICS

**Operating Temperature Range:**

-452° to +1200°F [-269° to +650°C].

**Elongation Capabilities:**

0.5% at +75°F [+24°C].

**Shelf Life:**

Minimum 1 year at +75°F [+24°C].

**Pot Life:**

Minimum 1 year at +75°F [+24°C].

**Temperature Coefficient of Expansion:**

7.0ppm/°F [13ppm/°C].

**Cure Requirements:**

**Precoat:** Air-dry 30 minutes at +75°F [+24°C], then 30 minutes at +200°F [95°C] followed by 30 minutes at +300°F [150°C].

**Final Coat:** Air-dry 30 minutes at +75°F [+24°C], then 30 minutes at +200°F [+95°C] followed by 30 minutes at +300°F [+150°C], and final 1 hour at +600°F [+315°C].

### PACKAGING OPTIONS

**Kits:**

1 jar powder [1lb/454gm]

1 bottle solvent [9oz/279ml]



## Strain Gage Cement



### OTHER ACCESSORIES USED IN A SAUEREISEN DKS-8 INSTALLATION:

- CSM Degreaser or GC-6 Isopropyl Alcohol
- Silicon-Carbide Paper
- M-Prep Conditioner A
- M-Prep Neutralizer 5A
- CSP-1 Cotton Swabs
- GSP-1 Gauze Sponges
- GT-11 Camel's Hair Brush
- SPT-1 Double Blade Spatula



**RoHS**  
COMPLIANT

### DESCRIPTION

Single-part chemical-setting, inorganic, Zircon-based cement supplied as a powder and mixed with water. High electrical-insulation and thermal-conductivity values. Used for installing high-temperature free-filament strain gages.

### CHARACTERISTICS

**Operating Temperature Range:**

-452° to +2500°F [-269° to +1370°C].

**Elongation Capabilities:**

0.5% at +75°F [+24°C].

**Shelf Life:**

Minimum 1 year at +75°F [+24°C].

**Pot Life:**

Minimum 1 year at +75°F [+24°C].

**Temperature Coefficient of Expansion:**

2.6ppm/°F [4.7ppm/°C].

**Cure Requirements:**

18 to 24 hours at +75°F [+24°C]. Application of heat will accelerate cure time.

**Recommended Postcure (Unclamped):**

1 hour at 50°F [30°C] above maximum operating temperature.

### PACKAGING OPTIONS

**Kits:**

1 bottle [4oz/115gm] powder

## Strain Gage Adhesive



### OTHER ACCESSORIES USED IN AN RTC EPOXY INSTALLATION:

- CSM Degreaser or GC-6 Isopropyl Alcohol
- Silicon-Carbide Paper
- M-Prep Conditioner A
- M-Prep Neutralizer 5A
- CSP-1 Cotton Swabs
- GSP-1 Gauze Sponges
- MJG-2 Mylar® Tape
- TFE-1 Teflon® Film
- HSC Spring Clamp
- GT-14 Pressure Pads and Backup Plates



**RoHS**  
COMPLIANT

### DESCRIPTION

General-purpose, two-component, adhesive for lab and field applications with post-yield, high-elongation strain gages. Also excellent for cryogenic strain measurement applications.

### CHARACTERISTICS

#### Operating Temperature Range:

−452° to +200°F [−269°C to +95°C].

#### Elongation Capabilities:

±15% at +75°F [+24°C].

#### Shelf Life:

Minimum 1 year at +75°F [+24°C].

#### Pot Life:

30 minutes at +75°F [+24°C].

#### Clamping Pressure:

5 to 20psi [35 to 140kN/m<sup>2</sup>].

#### Cure Requirements:

6 hours at +75°F [+24°C] or 1 hour at +175°F [+80°C].

#### Recommended Postcure (Unclamped):

1 hour at +120°F [+50°C] or 25°F [15°C] above maximum operating temperature.

### PACKAGING OPTIONS

#### Kits:

1 jar Part A [2oz/56gm]

1 jar Part B [1oz/28gm]

1 jar Part A [11oz/308gm]

1 jar Part B [5oz/140gm]

Mylar and Teflon are Registered Trademarks of DuPont

## Strain Gage Adhesive



### OTHER ACCESSORIES USED IN AN EPY-500 INSTALLATION:

- CSM Degreaser or GC-6 Isopropyl Alcohol
- Silicon-Carbide Paper
- M-Prep Conditioner A
- M-Prep Neutralizer 5A
- GSP-1 Gauze Sponges
- CSP-1 Cotton Applicators
- MJG-2 Mylar® Tape
- TFE-1 Teflon® Film
- HSC Spring Clamp
- GT-14 Pressure Pads and Backup Plates



**RoHS**  
COMPLIANT

### DESCRIPTION

EPY-500 is a two-part, heat-curing, filled epoxy system that is specially formulated for Micro-Measurements. This adhesive has reduced particle size, allowing a much thinner

glueline. The adhesive is compatible with all phenolic, epoxy-phenolic and polyimide strain gages.

### CHARACTERISTICS

**Operating Temperature Range:**

-425° to +500°F [-269° to +260°C].

**Shelf Life:**

Minimum 9 months

**Pot Life:**

24 hours

**Strain Limit – Single Cycle:**

5% at +75°F [+24°C]; 1% at -320°F [-195°C].

**Clamping Pressure:**

10 to 15psi [70 to 105kN/m<sup>2</sup>].

**Cure Requirements:**

26 hours at +200°F [+93°C]; or 4 hours at +250°F [+121°C]; or 1 hour at +350°F [+176°C]; or 1/2 hour at +400°F [+204°C].

**Recommended Post Cure:**

1 hour at +450°F [+232°C].

### PACKAGING OPTIONS

**Small Kit:**

5 [10g ea] packages

**Large Kit:**

2 [50g ea] packages

Mylar and Tefon are Registered Trademarks of DuPont

## Strain Gage Adhesive



### OTHER ACCESSORIES USED IN A QA-500 INSTALLATION:

- CSM Degreaser or GC-6 Isopropyl Alcohol
- Silicon-Carbide Paper
- M-Prep Conditioner A
- M-Prep Neutralizer 5A
- GSP-1 Gauze Sponges
- CSP-1 Cotton Applicators
- MJG-2 Mylar® Tape
- TFE-1 Teflon® Film
- HSC Spring Clamp
- GT-14 Pressure Pads and Backup Plates

**RoHS**  
 COMPLIANT

### DESCRIPTION

QA-500 is a specially formulated two-component, clear liquid and powder adhesive for use with strain gages. QA-500 has excellent moisture and chemical resistance.

### CHARACTERISTICS

**Operating Temperature Range:**  
 -320° to +500°F [-195° to +260°C].

**Shelf Life:**  
 Minimum 9 months

**Pot Life:**  
 24 hours

**Strain Limit – Single Cycle:**  
 2%

**Clamping Pressure:**  
 20 to 30psi [140 to 210kN/m<sup>2</sup>].

**Cure Requirements:**  
 2 hours at +250°F [+121°C] minimum.

**Postcure:**  
 (clamps removed) 4 hours at +50°F [+28°C] above maximum operating or curing temperature, whichever is higher.

### PACKAGING

**Kit:**  
 3 jars [7g ea] resin  
 3 jars [3g ea] hardener  
 3 stirring rods

Mylar and Teflon are Registered Trademarks of DuPont



# Installation Tools and Accessories

## Contents

### Tools

SSH-1 .....	42
STW-1.....	42
BTW-1.....	42
DPR-1 .....	42
SSC-1 .....	42
SSC-2 .....	42
SSS-1 .....	42
SSS-2 .....	42
DP-1.....	42
DWC-1 .....	42
NNP-1 .....	42
ATS-2.....	42
GT-11.....	43
SPT-1.....	43
SPT-2.....	43
HTC-1 .....	43
MHG-1 .....	43
MHG-2 .....	43

### General-Purpose

#### Tapes and Materials

PTC-2M .....	43
PDT-1 .....	43
PLY-001.....	43

### High-Temperature

#### Tapes and Materials

MJG-2 .....	44
TFT-1 .....	44
FGC-1 .....	44
TFE-2.....	44

### Clamping Supplies

HSC-1 .....	44
HSC-2 .....	44
HSC-3.....	44
GT-12.....	44
TFE-1.....	44
GT-14.....	44
SGP-1 .....	44
SGP-2 .....	44

## General Information and Selection

There is a strong element of craftsmanship involved in making consistently successful strain gage installations. As for any other field, this craft has its own special tools and working materials — found by seasoned professionals to be most effective for achieving the desired results. The installation accessories described on this and the following pages represent the distillation of many years' experience in determining the most appropriate tool or material for each task in the gage installation process.

Every accessory item listed here has been thoroughly tested and evaluated in the Micro-Measurements Applications Engineering Laboratory for quality and reliability, for ease of use, and for compatibility with all other Micro-Measurements products. It should be noted that the instruction bulletins supplied for gages, adhesives, protective coatings, etc. assume the availability of these accessories to the user, since such is generally the case for an experienced practitioner in a well-equipped laboratory.

### TOOLS

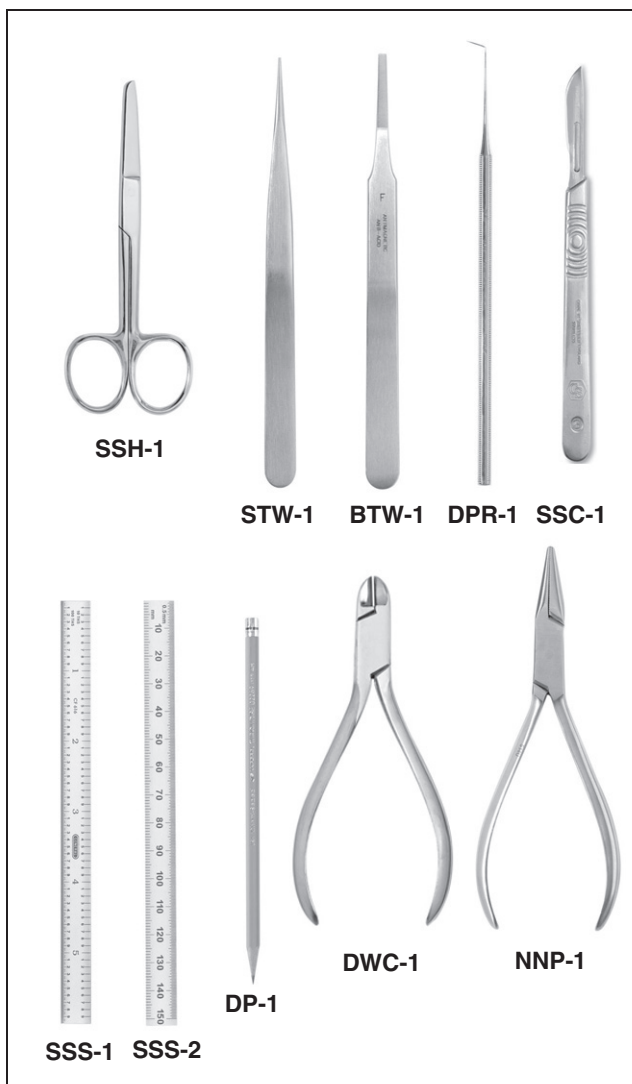

#### SSH-1 Surgical Shears:

Chromium steel, 4-1/2 in [115mm] long, with one sharp pointed blade and one blunt-end blade.

#### STW-1 Tweezers:

Stainless steel, 4-1/2 in [115mm] long. Rugged, precision ground sharp ends. Primarily used for handling leadwires.

#### BTW-1 Tweezers:

Stainless steel, 4-1/2 in [115mm] long. Antimagnetic; acid and corrosion resistant. Thin, flat blunt ends ideal for safe handling of strain gages.

#### DPR-1 Dental Probe:

Stainless steel "pick". Flexible 75° pointed tip.

#### SSC-1 Surgical Scalpel and Blade:

Stainless steel, uses SSC-2 snap-in replacement blade.

#### SSC-2 Replacement Scalpel Blades:

Five blades per package.

#### SSS-1 Steel Scale:

6 in [150mm] long, satin-chromed finish. Graduated in inches (1/32, 1/64, 1/10, 1/100).

#### SSS-2 Steel Scale:

6 in [150mm] long, satin-chromed finish. Graduated in inches (1/10, 1/100) and millimeters (0.5, 1).

#### DP-1 4-H Drafting Pencil:

For gage layout.

#### DWC-1 Diagonal Cutters:

Stainless steel, 4-1/2 in [115mm] long, precision cutter for wire up to AWG No. 18 [1mm diameter].

#### NNP-1 Needle-Nosed Pliers:

Nickel-chrome plated, 4-1/2 in [115mm] long, with serrated needle-nosed jaws.

#### ATS-2 Gage Application Tool Set:

Includes one of each item plus one additional DPR-1 Dental Probe. Durable, polypropylene box.

General Information and Selection

**TOOLS**



**GT-11 Camel's Hair Brush:**

3/8 in [9.5mm].

**SPT-1 Stainless Steel Mixing Spatula:**

Double blade. Overall length 8 in [200mm].

**SPT-2 Stainless Steel Mixing Spatula:**

Single blade. Overall length 7-3/4 in [195mm]. Wooden handle.

**HTC-1 Temperature Controlled Hotplate:**

Temperature range +100° to +600°F [+40° to +315°C]. Calibrated bimetallic thermostat. 3-1/2 in [90-mm] diameter aluminum alloy top plate. Embedded heating elements for high thermal conductivity. 120 Vac 6-ft [1.8-m] linecord, 3-wire plug.



**MHG-1 Master Mite Heat Gun:**

Lightweight, compact, perfectly balanced. 2 lb [0.9kg] with nozzle attached. 8-7/8 x 7 in [225 x 180mm]. Quiet, brushless-type shaded pole motor rated for continuous duty. Three interchangeable nozzle heating elements control average outlet temperature 1/2 in [13mm] from nozzle at +500°F [+260°C], +650°F [+345°C], or +800°F [+425°C]. Air-cooled barrel. Three-conductor grounded linecord. Slip-on deflector completely surrounds shrinkable tubing (HST-1) with heat. Pinpoint adapter directs heat without affecting adjacent areas. 120Vac, 60Hz. Maximum current draw 5.4 amps.

**MHG-2 Master Mite Heat Gun:**

Same as above, except 220Vac.

**GENERAL-PURPOSE TAPES & MATERIALS**

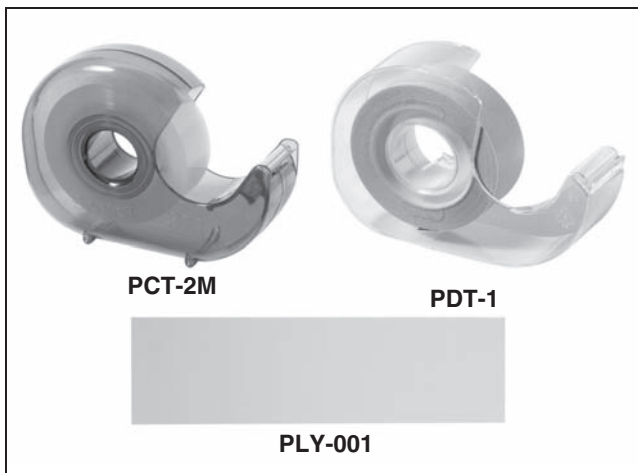

**PCT-2M Gage Installation Tape:**

For gage handling. 3/4 in x 75 ft [19mm x 23m].

**PDT-1 Paper Drafting Tape:**

For soldering mask, and lead positioning. 3/4 in x 400 in [19mm x 10m].

**PLY-001 Kapton® Film:**

For electrical insulation, 4 x 10 x 0.001 in thick. [100 x 250 x 0.02mm thick].



**RoHS**  
COMPLIANT

Kapton is a Registered Trademark of DuPont.

## General Information and Selection

### HIGH-TEMPERATURE TAPES & MATERIALS

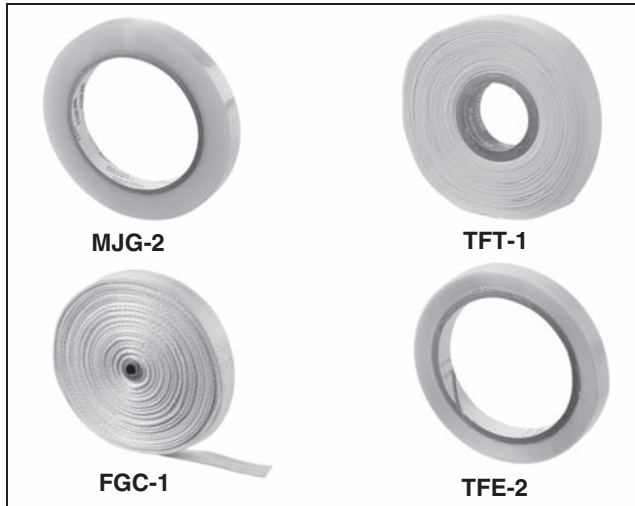

**MJG-2 Mylar® Tape:**

For gage handling with heat-curing resin systems. 1/2 in x 216 ft [13mm x 66m].

**TFT-1 Thermosetting (+340°F [+170°C]) Fiberglass Tape:**

For electrical insulation at high temperatures. 1/2 in x 60 ft [13mm x 20m].

**FGC-1 Woven Fiberglass Cloth:**

Bound edges. For lead anchoring when used in conjunction with M-Bond adhesives and M-Coat protective coatings. 0.015 in x 1 in x 50 yd [0.4mm x 25mm x 46m].

**TFE-2 High Modulus TFE Teflon® with Silicone Mastic:**

1/2 in x 108 ft [13mm x 33m].

### CLAMPING SUPPLIES

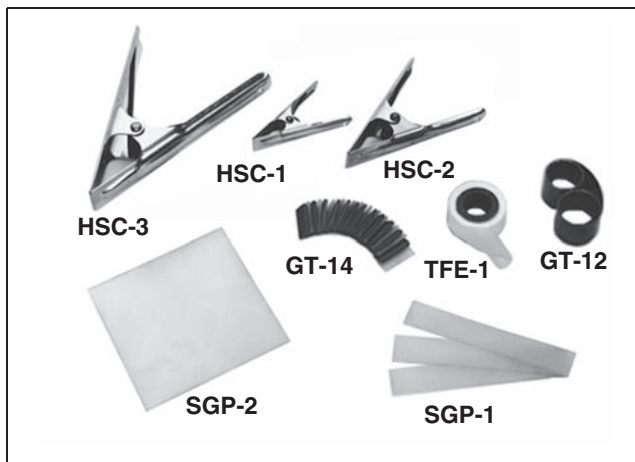

**HSC-3 Spring Clamp:**

**Maximum Opening:** 3 in [76mm].

**Maximum Recommended Opening:** 1-1/2 in [38mm].

**Nominal Clamp Force at Recommended Opening:** 25lbf [110N].

**GT-12 Neg'ator Constant Force Extension Spring Clamp:**

1 x 0.006 x 38 in [25mm x 0.4mm x 0.97m] stainless steel band, drum I.D. 1.16 in [30mm], 10.6lb [47N] load.

**TFE-1 Teflon Film:**

0.003 in x 1 in x 50 ft [0.08mm x 25mm x 15m].

**GT-14 Pressure Pads and Backup Plates:**

Kit of 12 Silicone Rubber Pads 3/32 x 1/2 x 1-1/4 in [2.5 x 13 x 32mm], and 12 aluminum plates, 1/8 x 1/2 x 1-1/4 in [3 x 13 x 32mm].

**SGP-1 Silicone Rubber:**

Three pieces, each 3/32 x 1 x 6 in [2.5 x 25 x 150mm].

**SGP-2 Silicone Rubber:**

One piece, 3/32 x 6 x 6 in [2.5 x 150 x 150mm].

**HSC-1 Spring Clamp:**

**Maximum Opening:** 1 in [25mm].

**Maximum Recommended Opening:** 1/2 in [13mm].

**Nominal Clamp Force at Recommended Opening:** 30lbf [135N].

**HSC-2 Spring Clamp:**

**Maximum Opening:** 2 in [51mm].

**Maximum Recommended Opening:** 1 in [25mm].

**Nominal Clamp Force at Recommended Opening:** 25lbf [110N].

Mylar and Teflon are Registered Trademarks of DuPont.





# Bondable Terminals

Copper Foil with  
Epoxy-Glass Laminate Backing (CEG)



Copper Foil with  
Polyimide Film Backing (CPF)

## Contents

CEG-25C.....	46
CPF-25C .....	46
CEG-38C.....	46
CPF-38C .....	46
CEG-50C.....	46
CPF-50C .....	46
CEG-75C.....	46
CPF-75C .....	46
CEG-100C.....	46
CPF-100C .....	46
CEG-150C.....	46
CPF-150C .....	46
CEG-50D.....	47
CPF-50D .....	47
CEG-60D.....	47
CPF-60D .....	47
CEG-75D.....	47
CPF-75D .....	47
CEG-100D.....	47
CPF-100D .....	47
CEG-60L .....	47
CPF-60L.....	47
CEG-75L .....	47
CPF-75L.....	47
CEG-AST .....	47
CPF-AST .....	47
CEG-21S.....	47
CEG-42S.....	47
CEG-63S.....	47
CEG-83S.....	47
CEG-125S.....	47

## Terminal Details and Descriptions

For many types of strain gages (such as Micro-Measurements EA-Series), instrument leadwires generally should not be attached directly to the solder tabs of the gage. Instead, the normal practice is to install bondable terminals adjacent to the gage, and solder the instrument leadwires to these. Small, flexible jumper wires, curved to form strain-

relief loops, are then connected from the terminals to the gage solder tabs. The accompanying drawings show typical strain gage terminal installations (see also Application Note TT-603. "The Proper Use of Bondable Terminals in Strain Gage Applications").



RoHS  
COMPLIANT

### TERMINAL CONSTRUCTION

Micro-Measurements bondable terminals are specially designed for use in strain gage circuits. They are produced from 0.0014-in [0.036-mm] thick, copper foil, laminated on either of two types of backing material. Both backings are readily bondable with strain gage adhesives. Terminals are offered in four different geometries, and in a range of sizes to suit varying gage installation needs.

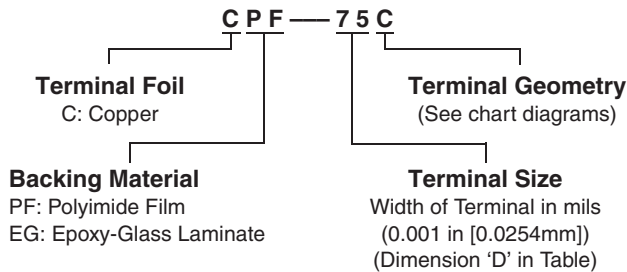

### BACKING MATERIALS

#### Type PF Polyimide Film:





0.003 in [0.08mm] thick. This is the preferred general-purpose backing material. It is more flexible and conformable than the Type EG, although not as strong. Type PF backing combines high-temperature capability, resistance to soldering damage and good electrical properties. It is suitable for long-term use at +450° to +500°F [+230° to +260°C], limited primarily by gradual oxidation of the copper foil interface. The relatively high thermal expansion coefficient of unfilled polyimide can cause loss of bond at temperatures below -100°F [-75°C].



#### Type EG Epoxy-Glass Laminate:

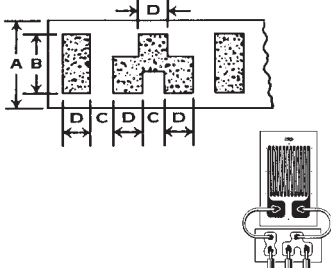



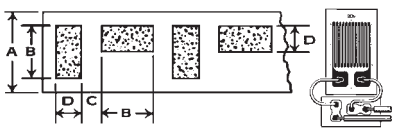

0.005 in [0.13mm] thick. This special laminate provides a strong but flexible backing for terminals. It is suitable for long-term use at +300°F [+150°C], and is recommended for cryogenic applications at temperatures down to -452°F [-269°C]. The radius of curvature of the mounting surface should generally be greater than 1/8 in [3mm].

Terminal Detail and Description	Terminal Pattern (Actual Size)	Dimensions (A dimensions are nominal)				Order Number	Package Strips of 4 Pairs
		A	B	C	D		
<p><b>Suffix C:</b> General-purpose. Widely used between gage jumper wires and main leadwire system. Suitable for many bridge intraconnection applications.</p>		0.11 [2.7]	0.065 [1.65]	0.025 [0.64]	0.025 [0.64]	CEG-25C CPF-25C	70
		0.14 [3.4]	0.095 [2.41]	0.030 [0.76]	0.038 [0.97]	CEG-38C CPF-38C	60
		0.18 [4.5]	0.125 [3.18]	0.036 [0.91]	0.050 [1.27]	CEG-50C CPF-50C	50
		0.25 [6.4]	0.190 [4.83]	0.040 [1.02]	0.075 [1.91]	CEG-75C CPF-75C	30
		0.33 [8.4]	0.250 [6.35]	0.070 [1.78]	0.100 [2.54]	CEG-100C CPF-100C	20
		0.48 [12.1]	0.375 [9.53]	0.070 [1.78]	0.150 [3.81]	CEG-150C CPF-150C	10

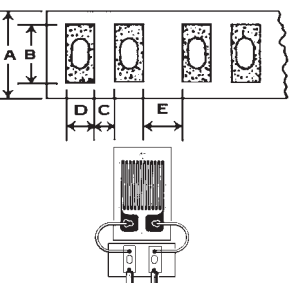
Terminal Details and Descriptions

Terminal Detail and Description	Terminal Pattern (Actual Size)	Dimensions (A dimensions are nominal)				Order Number	Package Strips of 4 Pairs
		A	B	C	D		
 <p><b>Suffix D:</b> Designed for installations with 2-wire jumper arrangement to gage and a 3-wire main lead system.</p>		0.18 [4.5]	0.125 [3.18]	0.036 [0.91]	0.050 [1.27]	CEG-50D CPF-50D	30
		0.21 [5.3]	0.150 [3.81]	0.038 [0.97]	0.060 [1.52]	CEG-60D CPF-60D	25
		0.25 [6.4]	0.190 [4.83]	0.040 [1.02]	0.075 [1.91]	CEG-75D CPF-75D	20
		0.33 [8.4]	0.250 [6.35]	0.050 [1.27]	0.100 [2.54]	CEG-100D CPF-100D	15

Terminal Detail and Description	Terminal Pattern (Actual Size)	Dimensions (A dimensions are nominal)				Order Number	Package Strips of 4 Pairs
		A	B	C	D		
 <p><b>Suffix L:</b> Primarily used to bring main leadwires out at right angles to terminal strip.</p>		0.21 [5.3]	0.150 [3.81]	0.040 [1.02]	0.060 [1.52]	CEG-60L CPF-60L	25
		0.25 [6.4]	0.190 [4.83]	0.050 [1.27]	0.075 [1.91]	CEG-75L CPF-75L	20
	<b>Terminal Assortment:</b> Contains 2 strips of C, D, and L patterns, except 1 strip of the 150C and 100D designs						CEG-AST CPF-AST

Terminal Detail and Description	Terminal Pattern (Actual Size)	Dimensions (A dimensions are nominal)					Order Number	Pkg Pairs
		A	B	C	D	E		
 <p><b>Suffix S:</b> Primarily used where soldering and desoldering may be encountered. Hole in center produces thermal isolation at each end of terminal. Not recommended for high cyclic endurance. Available only in epoxy-glass backing.</p>		0.13 [3.2]	0.063 [1.60]	0.021 [0.53]	0.021 [0.53]	0.042 [1.07]	CEG-21S	200
		0.21 [5.2]	0.125 [3.18]	0.042 [1.07]	0.042 [1.07]	0.084 [2.13]	CEG-42S	100
		0.29 [7.4]	0.190 [4.83]	0.063 [1.60]	0.063 [1.60]	0.126 [3.20]	CEG-63S	100
		0.37 [9.4]	0.250 [6.35]	0.083 [2.11]	0.083 [2.11]	0.166 [4.22]	CEG-83S	60
		0.54 [13.6]	0.375 [9.53]	0.125 [3.18]	0.125 [3.18]	0.250 [6.35]	CEG-125S	30





# Solders and Accessories

## Contents

### Solders

361A-20R.....	50
361-40R.....	50
430-20S.....	50
450-20R.....	50
450-20S.....	50
570-28R.....	50
1240-FPA.....	50

### Flux and Rosin Solvent Kits

FAR-1.....	51
RSK-1.....	51
RSK-2.....	51
RSK-4.....	51
FSS-1.....	51

### Soldering Units

M5S-1.....	51
M5S-2.....	51
M5S-3.....	51
M5S-A.....	51
M5S-B.....	51
M5S-C.....	51
M5S-D.....	51
M8S-1.....	52
M8S-A.....	52
M8S-B.....	52
M8S-RS.....	52
WRS-1.....	52
WRS-2.....	52
WRS-A.....	52

## Solders, Fluxes, Kits, and Soldering Units

The quality of the solder joints is a critical element in the performance of any strain gage installation. Because of special requirements associated with strain gage circuitry, many commercial solders and fluxes are not satisfactory for

this purpose. Micro-Measurements stocks and distributes a selection of solders and fluxes that have been carefully tested and qualified for use with strain gages.

### SOLDERS

Strain gage solders are listed below, along with their compositions, principal properties, and recommended applications. For ordering purposes, the solders are specified according to the coding system shown at right. All solders are supplied on spools, except for the 1240-FPA paste, which is supplied in a jar.

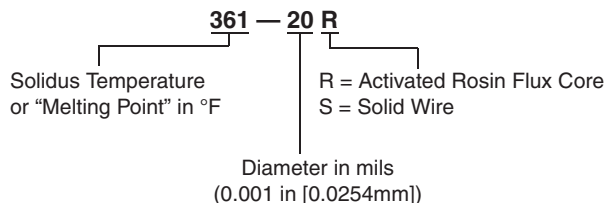

SOLDER SELECTION CHART							
Solder Type See Note 1	Packaging		Solidus/ Liquidus- Temperature	Wetting & Flow	Mech. Strength	Electrical Conductivity	Corrosion Resistance
	Order No.	Unit Size					
<b>361A-20R</b> 63% Tin 36.65% Lead 0.35% Antimony	361A-20R-25	25ft [7.6m]	361°/361°F [183°/183°C]	Excellent	Very Good	High	Good
	361A-20R	1lb [450g]					
Best all-around solder for general use. Also capable of use at cryogenic temperature.							
<b>361-40R</b> 63% Tin 37% Lead	361-40R-15	15ft [4.6m]	361°/361°F [183°/183°C]	Excellent	Very Good	High	Good
	361-40R	1lb [450g]					
General use with heavy leadwires. Not recommended for use at cryogenic temperatures.							
<b>430-20S</b> 96% Tin 4% Silver	430-20S-25	25ft [7.6m]	430°/430°F [221°/221°C]	Excellent	Very Good	Best	Excellent
	430-20S	1lb [450g]					
Recommended for use where high electrical conductivity is required. Good mechanical fatigue properties. Do not use at cryogenic temperatures.							
<b>450-20R</b> 95% Tin 5% Antimony	450-20R-25	25ft [7.6m]	450°/460°F [232°/238°C]	Excellent	Very Good	High	Good
	450-20R	1lb [450g]					
Higher temperature solder with very good handling properties. Can be used with M-Flux AR or M-Flux SS. Presence of antimony prevents "tin disease"; can be used in cryogenic environments, although quite brittle at low temperatures.							
<b>450-20S</b> 95% Tin 5% Antimony	450-20S-25	25ft [7.6m]	450°/460°F [232°/238°C]	Excellent	Very Good, Hard	High	Good
	450-20S	1lb [450g]					
Higher temperature solder with very good handling properties. Can be used with M-Flux AR or M-Flux SS. Presence of antimony prevents "tin disease", can be used in cryogenic environments, although quite brittle at low temperatures.							
<b>570-28R</b> 93.5% Lead 5% Tin 1.5% Silver	570-28R-20	20ft [6.1m]	565°/574°F [296°/301°C]	Very Good	Very Good, Hard	Fair	Fair
	570-28R	1lb [450g]					
High-lead content. For high-temperature connections and long-term use at cryogenic temperature.							
<b>1240-FPA</b> 40% Silver 28% Zinc 30% Copper 2% Nickel	1240-FPA	1oz [28g]	1220°/1435°F [660°/780°C]	Excellent	Excellent	High	Good
For very-high-temperature solder joints, generally with WK-Series strain gages. The WRS-1 Resistance Soldering Unit is an ideal tool for use with this solder. Has a shelf life of 9 months.							

**Note 1:** Products shown in bold are RoHS compliant.

## Solders, Fluxes, Kits, and Soldering Units

### FLUXES

With solid wire solders, it is necessary to use separate, externally applied fluxes. Even with rosin-core solders, flux may be helpful when soldering fine jumper wires to gage tabs or printed-circuit terminals, because not enough flux is released from the cored solder. It may also be necessary to supplement the cored flux in high-temperature solders such as Type 570.

Two fluxing compounds are available for strain gage soldering applications. M-Flux AR is an active but noncorrosive rosin flux that is effective on constantan, copper, and nickel. M-Flux SS is a very active acid flux that is used primarily with solid-wire solders applied to isoelastic

and K-alloy gages, and to stainless steel. The two fluxes should never be mixed. Whether the rosin or acid flux is used, it must be completely removed immediately after soldering to prevent degradation of protective coatings and corrosion of the metals, and to eliminate conductive flux residues. Rosin residues are best removed with M-LINE Rosin Solvent. Removal of M-Flux SS requires two steps: liberal applications of M-Prep Conditioner A, which must be blotted dry; and then M-Prep Neutralizer 5A, also to be blotted dry.

### FLUX AND ROSIN SOLVENT KITS (See Note 1)

#### FAR-1 M-Flux AR Kit:

Two 1-oz [30-ml] brush-cap bottles M-Flux AR.  
Two 1-oz [30-ml] brush-cap bottles M-LINE Rosin Solvent.

#### RSK-1 Rosin Solvent Kit:

Twelve 1-oz [30-ml] bottles M-LINE Rosin Solvent.

#### RSK-2 Rosin Solvent Bulk:

One quart (960-ml) bottle M-LINE Rosin Solvent.

#### RSK-4 Rosin Solvent Kit:

Four 1-oz [30-ml] bottles M-LINE Rosin Solvent.

#### FSS-1 M-Flux SS Kit:

One 1-oz [30-ml] applicator cap bottle M-Flux SS.  
One 1-oz [30-ml] brush-cap bottle M-Prep Conditioner A.  
One 1-oz [30-ml] brush-cap bottle M-Prep Neutralizer 5A.

**Note 1:** All products shown are RoHS compliant.

### MARK V SOLDERING STATION

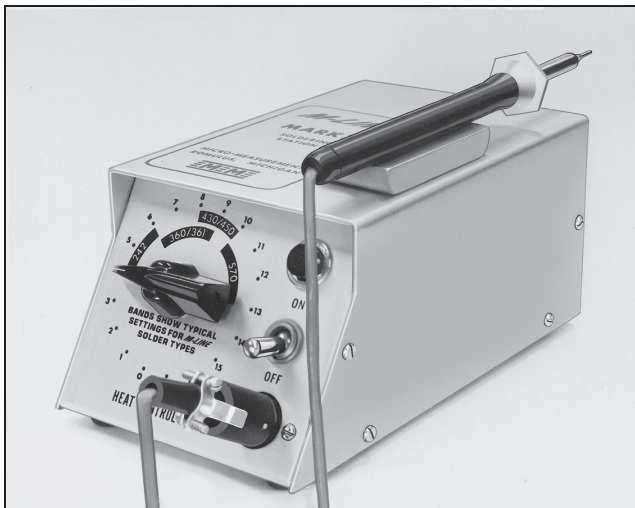

A time-proven precision soldering instrument for miniature and/or delicate soldering applications. Full 25-watt rating in 17 selector positions to handle all M-LINE solder alloys except 1240-FPA. Magnetic solder pencil holder and flexible, burn-resistant cord. Lightweight soldering pencil (1.1 oz [31g]). Specify 115 or 220Vac, 50 or 60Hz operation.

#### **M5S-1 Mark V Soldering Station,**

Complete with A and B tips

#### **M5S-2 Mark V Control Unit Only.**

#### **M5S-3 Mark V Soldering Pencil Only.**

#### **SOLDERING TIPS FOR MARK V**

Types A, B, and C tips are pretinned, ironclad copper, over-plated with nickel/chromium to retard oxidation. Type D is nickel-plated copper, particularly suited to high-temperature soldering.

**M5S-A** Type A, general-purpose 1/16 in [1.5mm] screwdriver.

**M5S-B** Type B, miniature 1/16 in [1.5mm] chisel.

**M5S-C** Type C, heavy duty 1/8 in [3mm] screwdriver.

**M5S-D** Type D, high-temperature 3/32 in [2.5mm] chisel.

**Note 1:** Products shown in bold are RoHS compliant.

### Solders, Fluxes, Kits, and Soldering Units

#### MARK VIII SOLDERING STATION



Manufactured for Micro-Measurements, the Mark VIII is a compact soldering unit with a lightweight soldering pencil. The modular design of the pencil allows for easy changing of tips, and heating element replacement. Includes both the M8S-A and M8S-B soldering tips, selected for ease of use with strain gages. The Mark VIII incorporates closed-loop control technology for precise tip temperature management. Tip temperature range of +500° to +800°F [+260° to +425°C] is ideal for most laboratory and field strain gage applications. The temperature control is color-coded for proper tip temperatures for all Vishay-Micro-Measurements soft solders. Not for use with Type 1240-FPA solder.

**M8S-1-XXX Mark VIII Soldering Unit, Complete,**  
XXX = Voltage 115 or 230 (Vac).

#### SOLDERING TIPS FOR MARK VIII

**M8S-A** Narrow tip 0.047 in [1.2mm] screwdriver.

**M8S-B** Wide tip 0.062 in [1.6mm] screwdriver.

**M8S-RS** Replacement Sponge, package of 1.



**RoHS**  
COMPLIANT

#### RESISTANCE SOLDERING UNIT

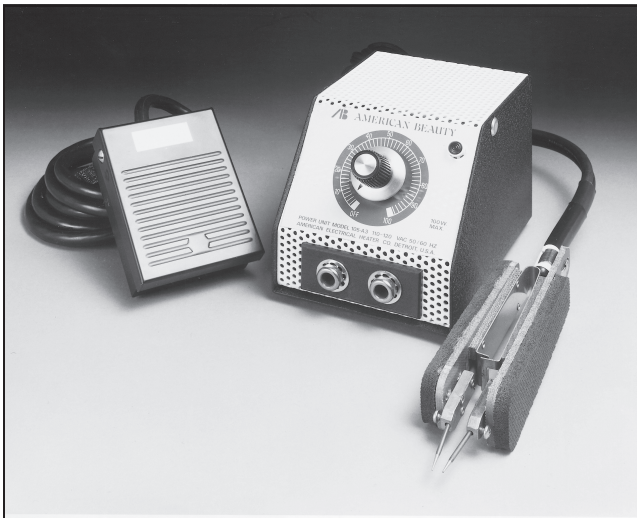

Used in combination with 1240-FPA silver-solder paste, this unit makes an excellent lead attachment system for strain gage operation above +500°F [+260°C]. The variable power control allows adjustment from zero to 100 watts and zero to 3 Vac. The power control is fused, and a pilot light is incorporated. The foot switch and tweezer soldering handpiece give excellent operator control over each solder joint. Includes power unit and foot switch, both with three-wire NEMA plugs, tweezer soldering handpiece, and replacement electrodes.

**WRS-1:** 110Vac.

**WRS-2:** 220Vac.

**WRS-A Replacement Electrodes:** Package of 6.

**References:** Application Note TT-606, "Soldering Techniques for Lead Attachment to Strain Gages with Solder Dots."  
Application Note TT-602, "Silver Soldering Technique for Attachment of Leads to Strain Gages."  
Application Note TT-609, "Strain Gage Soldering Techniques."





# Wire, Cable, and Accessories

## Contents

General Information and Selection .....	54
<b>Single-Conductor Wire</b>	
AWP .....	55
AWN .....	55
AWQ .....	55
GWF .....	55
HWN .....	55
JWN .....	55
DWV .....	55
FWK .....	55
FWT .....	55
<b>Three-Conductor Cable</b>	
DJV .....	56
DFV .....	56
BSV .....	56
DTV .....	56
DSV .....	56
FFE .....	56
FJT .....	56
FTE .....	56
GJF .....	56
<b>Four-Conductor Cable</b>	
DFV .....	57
DSV .....	57
BSV .....	57
DTV .....	57
FST .....	57
FTT .....	57
FFT .....	57
<b>Flat Ribbon Lead (Uninsulated)</b>	
1-GL-64-001 .....	57
1-KL-08-003 .....	57
1-KL-08-005 .....	57
1-KL-16-002 .....	57
<b>Accessories</b>	
HST-1 .....	58
WTS-1 .....	58
WTS-2 .....	58
WTS-A .....	58

## General Information and Selection



Different strain gage installation conditions and test specifications often necessitate the use of different types or sizes of leadwires. For accurate, reliable strain measurements, it is important to use an appropriate type of leadwire for each installation. Micro-Measurements stocks a wide variety of wires and cables, cataloged in tabular form on the following pages. All wires and cables listed in the tables have been proven in the field to give excellent sensor performance when properly used in the specified environments. Special gage wiring problems may require the use of wires not listed here. In such cases, our Applications Engineering Department can recommend appropriate wire types and can suggest suppliers.

### WIRE AND CABLE CODING SYSTEM

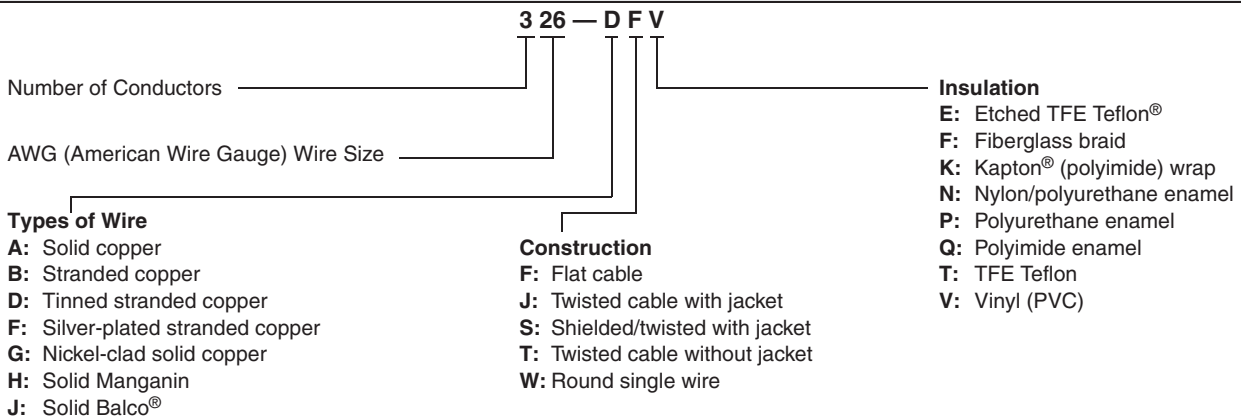

AWG	Diameter* (nominal)		AWG	Diameter* (nominal)	
	in	[mm]		in	[mm]
22	0.0253	0.643	34	0.0063	0.160
26	0.0159	0.404	36	0.0050	0.127
27	0.0142	0.361	37	0.0045	0.114
30	0.0100	0.254	42	0.0025	0.064

\*Solid Core Wire

Balco is a Registered Trademark of W.B. Driver Company.  
Teflon and Kapton are Registered Trademarks of DuPont.

### RIBBON WIRE CODING SYSTEM

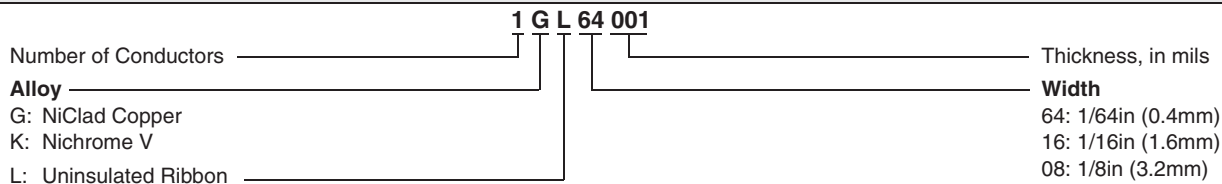

The Wire and Cable Coding System shown above gives the unique designation of each wire type for ordering purposes. The leadwire and cabling selection charts presented on the next three pages are organized according to the number of

conductors. All wires and cables are supplied on spools for user convenience. *Some styles may not be continuous length.*

**References:** Application Note TT-601, "Techniques for Bonding Leadwires to Surfaces Experiencing High Centrifugal Forces."  
Application Note TT-604, "Leadwire Attachment Techniques for Obtaining Maximum Fatigue Life of Strain Gages."  
Application Note TT-608, "Techniques for Attaching Leadwires to Unbonded Strain Gages."

General Information and Selection





<b>SINGLE-CONDUCTOR TYPES: SOLID WIRE</b>			
	Type	Packaging	Description
	Note 1	Foot [Meter]*	
<p>AWP      AWN</p> <p>AWQ      GWF</p> <p>HWN      JWN</p>	<b>134-AWP</b>	500ft [150m]	<b>Solid copper wire, polyurethane enamel:</b> General-purpose intragage hookup wire. Useful from -100° to +300°F [-75° to +150°C]. Enamel coating easily removed by applying heat from soldering iron.
	<b>136-AWP</b>	500ft [150m]	
	<b>127-AWN</b>	500ft [150m]	<b>Solid copper wire, nylon/polyurethane enamel:</b> Identical in use and specifications to Type AWP above, but with superior abrasion resistance and slightly reduced insulation resistance at elevated temperatures. 134-AWN is available in four colors; specify: -R (red), -W (white), -B (black), -G (green).
	<b>130-AWN</b>	500ft [150m]	
	<b>134-AWN</b>	500ft [150m]	
	<b>127-AWQ</b>	500ft [150m]	<b>Solid copper wire, polyimide enamel:</b> Intragage hookup wire. Temperature range -452° to +600°F [-269° to +315°C] short term. Enamel is extremely tough and abrasion resistant, with excellent electrical properties; generally removed by mechanical scraping or sanding.
	<b>130-AWQ</b>	500ft [150m]	
	<b>134-AWQ</b>	500ft [150m]	
	<b>126-GWF</b>	100ft [30m]	<b>Solid nickel-clad copper wire, fiberglass braid insulation:</b> Useful from -452° to +900°F [-269° to +480°C]. Recommended for use with WK-Series gages when silver solder is used for lead attachment.
	<b>126-GWF</b>	1000ft [300m]	
<b>137-HWN</b>	200ft [60m]	<b>Solid manganin wire, nylon/polyurethane enamel:</b> Used for bridge balance and span set in transducer circuits. Nominal resistance: 14 ohms/ft [50 ohms/m]. Temperature range: +10° to +125°F [-10° to +50°C].	
<b>142-JWN</b>	500ft [150m]	<b>Solid Balco® wire, nylon/polyurethane enamel:</b> Used for bridge temperature compensation of zero shift or span. Nominal resistance: 19 ohms/ft [65 ohms/m]. Temperature coefficient of resistance: +0.25%/°F [+0.45%/°C]. Temperature range: +10° to +300°F [-10° to +150°C].	
<b>SINGLE-CONDUCTOR TYPES: STRANDED WIRE</b>			
	Type	Packaging	Description
		Foot [Meter]*	
<p>DWV      FWK      FWT</p>	126-DWV	100ft [30m]	<b>Stranded tinned-copper wire, vinyl insulation:</b> General-purpose leadwire. Useful to +180°F [+80°C]. Vinyl insulation becomes brittle at low temperature; not normally used below -60°F [-50°C]. Specify red, white, black, or green.
	126-FWK	25ft [7.5m]	<b>Stranded silver-plated copper wire, Kapton® polyimide insulation:</b> High-performance. Recommended for unusually severe service from -452° to over +600°F [-269° to +315°C] short term. Excellent resistance to abrasion, radiation, and outgassing in high vacuum. Treated for bondability.
	130-FWT	100ft [30m]	<b>Stranded silver-plated copper wire, Teflon® insulation:</b> Wide temperature range. Useful from -452° to +500°F [-269° to +260°C]. When bonding to Teflon-insulated wire, insulation must be treated with Tetra-Etch® compound (see "Special-Purpose Materials.") Specify red, white, black, or green.

\*Some types may not be continuous length.

**Note 1:** Products shown in bold are RoHS compliant.

Balco is a Registered Trademark of W.B. Driver Company.  
Kapton and Teflon are Registered Trademarks of DuPont.  
TetraEtch is a Registered Trademark of W.L. Gore.

## General Information and Selection

	<b>THREE-CONDUCTOR CABLE</b>		
	Type Note 1	Packaging Foot [Meter]*	Description
 DJV      DFV	322-DJV	500ft [150m]	<b>Stranded tinned-copper wire, 3-conductor twisted cable, chrome PVC vinyl jacket, vinyl insulation:</b> Good choice for use with EGP-Series Embedment Strain Gages. Color-coded red/white/black.
	<b>326-DFV</b> <b>330-DFV</b> <b>330-DFV</b>	100ft [30m] 1000ft [300m] 100ft [30m] 1000ft [300m]	<b>Stranded tinned-copper wire, 3-conductor flat cable, vinyl insulation:</b> Convenient general-purpose cable. For use from -60° to +180°F [-50° to +80°C]. Flat construction requires minimum space. Color-coded red/white/black.
 BSV      DTV      DSV	<b>326-BSV</b> <b>326-BSV</b>	100ft [30m] 1000ft [300m]	<b>Stranded copper wire, 3-conductor twisted cable, PVC insulated, braided shield:</b> For use from -60° to 180°F [-50° to +80°C].
	326-DTV 326-DTV	100ft [30m] 1000ft [300m]	<b>Stranded tinned-copper wire, 3-conductor twisted cable, vinyl insulation:</b> Convenient general-purpose cable for low electrical noise pickup. For use from -60° to +180°F [-50° to +80°C]. Color-coded red/white/black.
	326-DSV 326-DSV	100ft [30m] 1000ft [300m]	<b>Stranded tinned-copper wire, 3-conductor twisted cable, vinyl insulation, braided shield, vinyl jacket:</b> Special-purpose cable to minimize electrical noise interference. Useful from -60° to +180°F [-50° to +80°C]. Color-coded red/white/black.
 FFE	<b>330-FFE</b> <b>330-FFE</b>	100ft [30m] 1000ft [300m]	<b>Stranded silver-plated copper wire, 3-conductor flat cable, etched Teflon® insulation:</b> For use from -452° to +500°F [-269° to +260°C]. Color-coded red/white/black. Insulation treated for bonding.
 FJT      FTE      GJF	<b>330-FJT</b> <b>330-FJT</b>	100ft [30m] 1000ft [300m]	<b>Stranded silver-plated copper wire, 3-conductor twisted cable, Teflon insulation, Teflon jacket:</b> Small, flexible. For use from -452° to +500°F [-269° to +260°C]. Color-coded red/white/black. When bonding Teflon-insulated wire, insulation must be treated with Tetra-Etch® compound (see "Special-Purpose Materials.")
	336-FTE	50ft [15m]	<b>Stranded silver-plated copper wire, 3-conductor twisted cable, etched Teflon insulation:</b> Small, flexible cable. For use from -452° to +500°F [-269° to +260°C]. Color-coded red/white/black. Insulation treated for bonding.
	330-FTE 330-FTE	100ft [30m] 500ft [150m]	<b>Stranded silver-plated copper wire, 3-conductor twisted cable, etched Teflon insulation:</b> For use from -452° to +500°F [-269° to +260°C]. Color-coded red/white/black. Insulation treated for bonding.
	<b>326-GJF</b> <b>326-GJF</b>	100ft [30m] 1000ft [300m]	<b>Solid nickel-clad copper wire, 3-conductor twisted cable, fiberglass braid insulation and jacket:</b> For use from -452° to +900°F [-269° to +480°C]. Recommended for use with WK-Series gages when silver solder is used for lead attachment. Color-coded red/white/black.

\*Some types may not be continuous length.

**Note 1:** Products shown in bold are RoHS compliant.

Teflon are Registered Trademarks of DuPont.

TetraEtch is a Registered Trademark of W.L. Gore.

General Information and Selection

		<b>FOUR-CONDUCTOR CABLE</b>		
		Type Note 1	Packaging Foot [Meter]*	Description
<p>DFV      DSV</p> <p>DTV      FST</p> <p>BSV      FFT</p> <p>FFT</p>	<b>426-DFV</b>	100ft [30m]	<b>Stranded tinned-copper wire, 4-conductor flat cable, vinyl insulation:</b> For use from -60° to +180°F [-50° to +80°C]. Conductors easily separated for stripping and wiring. Color-coded red/white/black/green.	
	<b>426-DFV</b>	1000ft [300m]		
	<b>430-DFV</b>	100ft [30m]		
	<b>430-DFV</b>	1000ft [300m]		
	422-DSV	100ft [30m]	<b>Stranded tinned-copper wire, 4-conductor polypropylene insulated:</b> Twisted shielded pairs (red/black and white/green) with a drain wire, PVC jacket. For use from -60° to +180°F [-30° to +60°C].	
	422-DSV	1000ft [300m]		
	<b>426-BSV</b>	100ft [30m]	<b>Stranded copper wire, 4-conductor twisted cable, PVC insulated braided shield:</b> For use from -60° to +180°F [-50°C to +80°C].	
	<b>426-BSV</b>	1000ft [300m]		
	426-DTV	100ft [30m]	<b>Stranded tinned-copper wire, 4-conductor twisted cable, vinyl insulation:</b> For use from -60° to +180°F [-50° to +80°C]. Color-coded red/white/black/green.	
	426-DTV	1000ft [300m]		
430-FST	100ft [30m]	<b>Stranded silver-plated copper wire, 4-conductor twisted cable, Teflon® insulation, braided shield, Teflon jacket:</b> Small, flexible cable. For use from -452° to +500°F [-269° to +260°C]. Color-coded red/white/black/green. When bonding Teflon-insulated wire, insulation must be treated with Tetra-Etch® compound (see Special-Purpose Materials, document number 11008).		
430-FST	1000ft [300m]			
<b>436-FFT</b>	100ft [30m]	<b>Stranded silver-plated copper wire, 4-conductor twisted cable, Teflon® insulation:</b> Small, flexible cable. For use from -452° to +500°F [-269° to +260°C]. Color coded red, white, black, green. When bonding Teflon insulated wire, insulation must be treated with Teflon etchant, such as TEC-1 (see Special-Purpose Materials, document number 11008).		
<b>436-FFT</b>	500ft [150m]			
426-FFT	100ft [30m]	<b>Stranded silver-plated copper wire, 4-conductor flat cable, Teflon® insulation:</b> For use from -452° to +500°F [-269° to +260°C]. Color coded red, white, black, green. When bonding Teflon insulated wire, insulation must be treated with a Teflon etchant, such as TEC-1 (see Special-Purpose Materials, document number 11008).		
426-FFT	500ft [150m]			
		<b>FLAT RIBBON LEAD (UNINSULATED)</b>		
		Type	Packaging Foot [Meter]*	Description
	<b>1-GL-64-001</b>	50ft [15m]	<b>Uninsulated flat ni-clad copper ribbon:</b> 1/64in wide x 0.001in thick [0.4 x 0.025mm]. For use from -452 to 900°F [-269 to +480°C]. Can be easily soldered or spot welded.	
	<b>1-KL-16-002</b>	50ft [15m]	<b>Uninsulated Nichrome V:</b> 1/16in wide x 0.002in thick [1.6 x 0.05mm]. For use from -452 to +2000°F [-269 to +1100°C].	
	<b>1-KL-08-003</b>	50ft [15m]	<b>Uninsulated Nichrome V:</b> 1/8in wide x 0.003in thick [3.2 x 0.08mm]. For use from -452 to +2000°F [-269 to +1100°C].	
	<b>1-KL-08-005</b>	50ft [15m]	<b>Uninsulated Nichrome V:</b> 1/8in wide x 0.005in thick [3.2 x 0.127mm]. For use from -452 to +2000°F [-269 to +1100°C].	

\*Some types may not be continuous length.

**Note 1:** Products shown in bold are RoHS compliant.

Teflon is a Registered Trademark of DuPont.

Tetra-Etch is a Registered Trademark of W.L. Gore

## General Information and Selection

### HST-1 HEAT-SHRINKABLE WIRE SPLICE SEALANT



Fast, easy-to-use method for protecting wire splice connections. Constructed of irradiated polyolefin plastic tubing with a heat-flowable inner liner sealant. Forms an immediate and tight seal to splice connection at a shrink temperature of +275°F [+135°C]. Inside diameter before heating is 0.125in [3.2mm]; after heating, 0.023in [0.6mm]. Large range of shrinkage allows use with leadwire insulation diameters from 0.03 to 0.11 in [0.75 to 2.8mm]. The operating temperature range is -65° to +230°F [-55° to +110°C]. Package of eight 6-in [150-mm] lengths.

### THERMAL WIRE STRIPPER



The ease and simplicity of operation of the Thermal Wire Stripper make it ideal for most strain gage leadwire stripping. The variable heat control allows stripping of all thermoplastic insulations, including Teflon®, in sizes No. 18 to No. 36 AWG [1 to 0.1mm diameter]. The foot switch and tweezer handpiece give excellent operator control over the stripping operation. Includes power unit and foot switch, both with 3-wire NEMA plugs, and tweezer handpiece.

**WTS-1:** 110Vac

**WTS-2:** 220Vac

**WTS-A Replacement Elements**

Set of two.

Teflon is a Registered Trademark of DuPont.



# Protective Coatings

## Contents

General Information .....	60
M-Coat A .....	62
M-Coat B .....	63
M-Coat C .....	64
M-Coat D .....	65
M-Coat F .....	66
M-Coat FBT .....	67
M-Coat J .....	68
M-Coat W-1 .....	69
3140 RTV .....	70
3145 RTV .....	71
M-Bond AE-10 and AE-15.....	72
M-Bond 43-B .....	73
M-Bond GA-61 .....	74
Barrier E .....	75
Barrier WD .....	76
Gagekote #1 .....	77
Gagekote #5 .....	78
Gagekote #8 .....	79
Gagekote #11 .....	80

## General Information

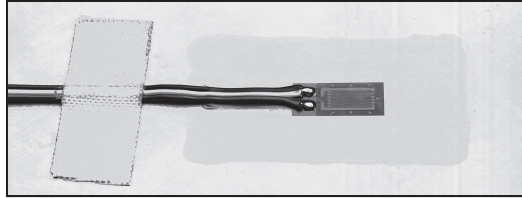

M-Coat A — General-purpose “transparent” polyurethane.

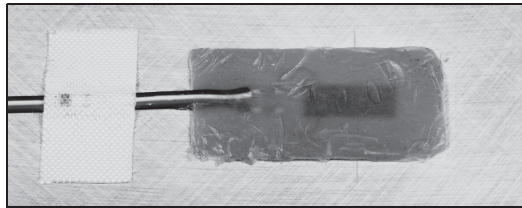

M-Coat W-1 — Microcrystalline wax.

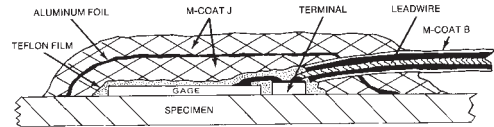

Cross-sectional view of typical long-term installation

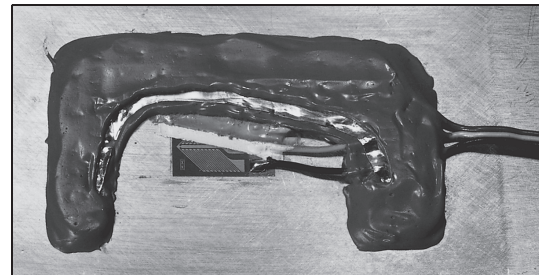

Recommended protective coating system for gage installations that must operate submerged in water for long periods of time

Strain gage performance is easily degraded by the effects of moisture, chemical attack, or mechanical damage. As a result, gages require varying degrees of protection according to the severity of the environment in which they must operate. While it is often practical to operate fully encapsulated gages without additional protection, in laboratory applications, open-faced gages should always be covered with a suitable coating as soon as possible after installation.

The coating compounds described on the following pages have been formulated specifically for use in protecting strain gage installations from damaging environmental conditions. The range of materials is adequate for handling the majority of gage protection requirements. In an air-conditioned laboratory, for instance, a single layer of M-Coat A would

ordinarily provide sufficient protection against moisture, fingerprints, and other contaminants. When the gage installation must operate in a more severe environment, alternate coatings or combinations of coatings can be employed as illustrated above.

To serve as a preliminary guide for coating selection, the chart on the next page gives recommended coating systems for a variety of typical environments. The effectiveness of these materials and procedures has been experimentally validated on numerous occasions. However, application technique is also an important factor in the performance of any gage protection system. It is therefore good practice, particularly in the case of long-term installations, to verify by test that the system performs as required.

### APPLICATION NOTES FOR PROTECTIVE COATINGS

- For long-term tests, or in particularly hostile environments, carefully clean the surface before applying any protective coating. Coating extending into uncleaned areas will eventually loosen.
- When several layers of coating are required, extend each overcoat beyond the previous layer.
- Incomplete protection around leadwires is a common cause of moisture penetration into gage installations. (Many commercial leadwire insulations contain pinholes.)
- Seal wire splices with HST-1 Heat Shrinkable Tubing.
- Before applying any protective coating to an unprotected installation that has been exposed to high humidity, dry the installation thoroughly.
- If the coating is a room-temperature-curing type, the moisture absorption rate can be decreased by post-curing at an elevated temperature.
- Generally, a thick coating offers a more resistant path to moisture absorption than a thin one.
- For a further vapor barrier, apply an intermediate layer of metal foil (aluminum, such as M-Coat FA-2, or stainless steel), or TFE Teflon® film (first treated with TEC-1 Tetra-Etch® compound for optimum bond). Since moisture can only penetrate around the edges of the foil or film, the path to the gage is much longer.
- To evaluate protective coatings for long-term testing, monitor the zero-shift of the gage. Resistance-to-ground measurements can also indicate deterioration.

Teflon is a Registered Trademark of DuPont.

Tetra-Etch is a Registered Trademark of W.L. Gore.



General Information

<b>COATINGS SELECTION GUIDE</b>		
Environment	Recommendation	
	Preferred	Alternate
<b>Typical Laboratory:</b> 50%, or lower, relative humidity	M-Coat A	M-Coat C, or M-Coat D, or M-Coat F
<b>Field Applications:</b> Outdoor installations, shielded from rain and snow	M-Coat F	M-Coat J
<b>High Humidity, Water Splash:</b> Laboratory and field applications under damp or wet conditions	Short Term: 3140 RTV  Long Term: M-Coat W-1 Wax	Short Term: 3145 RTV  Long Term: M-Coat F
<b>Water Immersion:</b> Short-term, fresh water or salt water  Long-term, fresh water  Long-term, salt water  High-pressure water	Teflon® + M-Coat B (on vinyl-insulated leadwires) + M-Coat J  Per diagram and photo on previous page  Per diagram and photo on previous page plus metal cap and conduit for leadwires  Per diagram and photo on previous page	M-Coat W-1 Wax  M-Coat W-1 Wax, or M-Coat F  None  M-Coat F, or M-Coat W-1 Wax for short-term
<b>Steam:</b> +212°F [+100°C], long-term installation	Hermetically sealed metal cap, and conduit for leadwires	None
<b>Concrete Surfaces:</b> Long-term	Per diagram and photo on previous page, preceded by M-Bond AE-10	M-Bond GA-61 to seal concrete surface
<b>Oils and Gasoline:</b> Commercial oils, to +180°F [+80°C], gasoline, and kerosene  Synthetic oils, to +200°F [+95°C]	M-Coat D plus two or three layers of M-Coat B  Two or three layers of M-Bond 43B	3145 RTV + M-Coat B  M-Bond GA-61
<b>High-Temperature Air:</b> To +500°F [+260°C], with good mechanical protection	Short Term: M-Bond GA-61	3145 RTV

Teflon is a Registered Trademark of DuPont.

## Protective Coating



### FEATURES

- Easy to use
- Transparent
- Good general-purpose coating for laboratory use



**RoHS**  
COMPLIANT

### DESCRIPTION

Air-drying solvent-thinned (xylene) polyurethane. Transparent. Moderate hardness; good flexibility. Can be removed with *M-LINE* Rosin Solvent or toluene. Film thickness 0.005-0.01 in [0.1-0.25mm] per coat.

General-purpose coating for lab use, and as base coating for field applications. Must be fully cured before addition of other coatings. Fair moisture resistance. Not readily attacked by many solvents. Convenient to use.

### CHARACTERISTICS

#### Cure Requirements:

Dries tack-free at room temperature in 20 minutes. Completely dry in 2 hours.

Normal cure 24 hours at room temperature. Chemical resistance and coating hardness increase for 6 to 7 days.

#### Operating Temperature Range:

**Short Term:** -100° to +300°F [-75° to +150°C].  
**Long Term:** -100° to +250°F [-75° to +120°C].

#### Shelf Life:

Minimum 1 year at +75°F [+24°C].

### PACKAGING OPTIONS

#### Kit:

4 brush-cap bottles (1oz [30ml] ea)

#### Bulk:

Quart container

## Protective Coating



### FEATURES

- Good resistance to chemicals
- Air drying
- Also used for priming leadwires



**RoHS**  
COMPLIANT

### DESCRIPTION

Air-drying solvent-thinned (MEK) nitrile rubber. Forms flexible rubbery coating. Do not use directly on exposed foil or bare leads. Often used to prime vinyl-insulated wire to improve bondability to other coatings. If used as primer on

leads, thin 50:50 with MEK. Flexible at cryogenic temperatures. Excellent resistance to gasoline, kerosene, commercial oils. Electrical properties poorer than other M-Coats, particularly at elevated temperatures.

### CHARACTERISTICS

#### Cure Requirements:

Air-dries in 1 hour at +75°F [+24°C]. Do not apply subsequent protective coatings for at least 2 hours from time of application. Normal cure 24 hours at room temperature.

Further improve chemical resistance with 1 hour bake at +200°F [+95°C].

#### Operating Temperature Range:

**Short Term:** -320° to +300°F [-195° to +150°C].

**Long Term:** -320° to +200°F [-195° to +95°C].

#### Shelf Life:

Minimum 1 year at +75°F [+24°C].

### PACKAGING OPTIONS

#### Kit:

4 brush-cap bottles (1 oz [30ml] ea)

#### Bulk:

Quart container

## Protective Coating

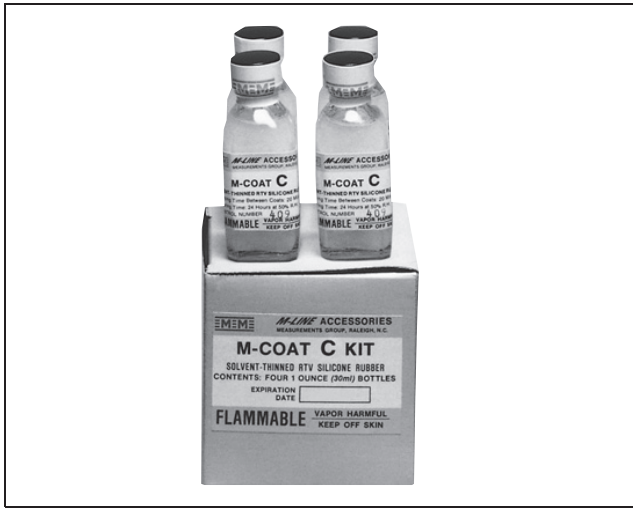

### FEATURES

- Air drying
- Low reinforcement
- Transparent



**RoHS**  
COMPLIANT

### DESCRIPTION

Solvent-thinned (naphtha) RTV silicone rubber. Cures to tough, rubbery transparent film. Good all-around mechanical and electrical properties. Completely noncorrosive. Film thickness 0.015-0.02 in [0.4-0.5mm] per coat.

Recommended for lab and field installations that require a high degree of protection in thin coatings. Good water-splash protection. Good chemical resistance.

### CHARACTERISTICS

#### Cure Requirements:

Solvents evaporate in about 60 minutes at room temperature. Allow 20 minutes drying time between coats.

Cures in 24 hours at +75°F [+24°C] and 50% RH. Longer cure at lower humidity.

#### Operating Temperature Range:

**Short Term:** -75° to +550°F [-60° to +290°C].

**Long Term:** -75° to +500°F [-60° to +260°C].

#### Shelf Life:

Minimum 9 months at +75°F [+24°C] kept tightly sealed.

### PACKAGING OPTIONS

#### Kit:

4 brush-cap bottles (1oz [30ml] ea)

#### Bulk:

Quart container

## Protective Coating

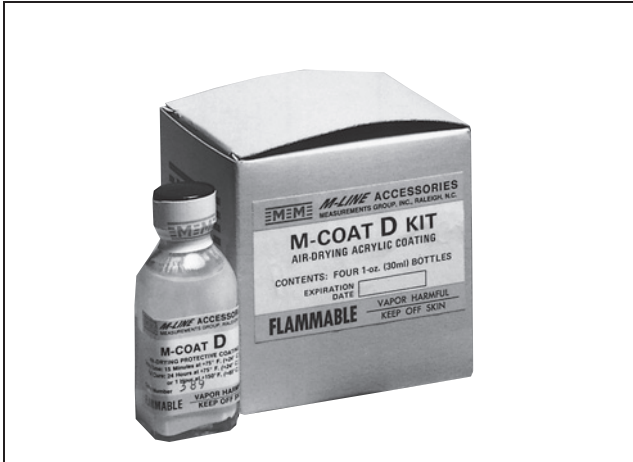

### FEATURES

- Air drying
- Opaque
- Good base coating



**RoHS**  
COMPLIANT

### DESCRIPTION

Air-drying solvent-thinned (toluene) acrylic. Dense white color for easy visual inspection of coverage. Forms hard thin coating capable of high elongation. Can be removed with *M-LINE* Rosin Solvent or toluene. Apply in thin coats to prevent solvent entrapment. Film thickness 0.005-0.01 in [0.1-0.25mm] per coat.

Good general laboratory moisture barrier. Electrical leakage negligible even when uncured. Good base coating for subsequent applications of M-Coat B. Convenient for anchoring and insulating intrabridge wiring and jumper leads. Chemical resistance only fair but can be improved by postcure at +175°F [+80°C] for 30 minutes.

### CHARACTERISTICS

#### Cure Requirements:

Solvents evaporate in about 30 minutes at +75°F [+24°C]. Fully cured in 24 hours. Overcoats can be applied 30 minutes from time of application. Coating binder begins to sublimate at +280°F [+140°C], but residue is inorganic and will not become conductive.

#### Operating Temperature Range:

**Short Term:** -100° to +325°F [-75° to +160°C].

**Long Term:** -100° to +250°F [-75° to +120°C].

#### Shelf Life:

Minimum 1 year at +75°F [+24°C] kept tightly sealed.

### PACKAGING OPTIONS

#### Kit:

4 brush-cap bottles (1 oz [30ml] ea)

#### Bulk:

Quart container

## Protective Coating



### FEATURES

- Excellent for outdoor applications
- No cure required
- Versatile

### DESCRIPTION

Kit of selected materials easily applied in various combinations. Provides environmental and mechanical protection. Particularly well-suited to field applications where conditions are not ideal. Typical applications include

pipelines, tunnels, bridges, reinforcement bars in concrete structures, heavy machinery, ships, aircraft, motor vehicles, and pressure vessels.

### CHARACTERISTICS

**Cure Requirements:**

No mixing or curing required.

**Operating Temperature Range:**

**Short Term:** -70° to +250°F [-55° to +120°C].

**Long Term:** -20° to +175°F [-30° to +80°C].

**Shelf Life:**

Minimum 1 year at +75°F [+24°C].

### PACKAGING OPTIONS

**Kit:**

12 pieces (4-1/2in x 3-3/4in x 1/8in [115 x 95 x 3.2mm]) each:

- M-Coat FB Butyl Rubber Sealant
- M-Coat FN Neoprene Rubber Sheets

1 roll (0.003in x 2in x 20ft [0.08mm x 50mm x 6m])

M-Coat FA Aluminum Foil Tape

2 brush-cap bottles (1/2oz [15ml] ea)

M-Coat B Air-Drying Nitrile Rubber Coating

M-Coat FT Teflon® Tape

**Bulk:**

M-Coat FB-2 Butyl Rubber Sealant — 25 pieces

M-Coat FN-2 Neoprene Rubber Sheets — 25 pieces

M-Coat FA-2 Aluminum Foil Tape — 20-ft [6-m] roll

M-Coat B Air-Drying Nitrile Rubber Coating —

4 brush-cap bottles (1oz [30ml] ea)

M-Coat FT Teflon® Tape

1-x-20-x-0.003-in [25-x-500-0.08-mm] — 10 pieces

Teflon is a Registered Trademark of DuPont.

## Protective Coating



### FEATURES

- Excellent protection from moisture
- Low reinforcement
- Easy to apply



**RoHS**  
COMPLIANT

### DESCRIPTION

Solvent-thinned butyl rubber designed to provide excellent moisture protection with low reinforcement effects. Principally used in transducers. Exhibits a paste-like

consistency and is normally applied with a spatula. Thickness over 0.1 in [2.5mm] not recommended.

### CHARACTERISTICS

#### Cure Requirements:

Air dry 8 hours, followed by an elevated temperature cure of +150° to +175°F [+65° to +80°C] for 4 to 6 hours.

#### Operating Temperature Range:

0° to +175°F [-20° to +80°C].

#### Shelf Life:

Minimum 12 months at +75°F [+24°C].

### PACKAGING OPTIONS

#### Kit:

75g collapsible tubes, 4 each

#### Bulk:

Quart container

## Protective Coating



### FEATURES

- Excellent resistance to moisture
- Good resistance to chemicals
- Good protection against mechanical damage
- Room-temperature cure

**RoHS**  
 COMPLIANT

### DESCRIPTION

Two-part polysulfide liquid polymer compound. Can be applied in coating thickness of 1/8 in [3 mm] without flowing on vertical surfaces. Tough, flexible coating. No weighing required. Uncured coating can be removed with CSM Degreaser, Rosin Solvent, or MEK.

General-purpose coating. Good protection against oil, grease, most acids and alkalis, and most solvents. Strong solvents may cause swelling and softening with time. Concentrated acids eventually break down coating. Good salt-water immersion coating.

### CHARACTERISTICS

#### Cure Requirements:

Mixed pot life 30 minutes at +75°F [+24°C].

Normal cure in 24 hours at +75°F [+24°C].

To accelerate cure and improve properties, cure 2 hours at +130°F [+55°C].

#### Operating Temperature Range:

**Short Term:** -50° to +250°F [-45° to +120°C].

**Long Term:** -50° to +200°F [-45° to +95°C].

#### Shelf Life:

Minimum 5 months at +75°F [+24°C].

### PACKAGING OPTIONS

#### M-Coat J-1:

- 1 mixing dispenser [70g]
- 1 piece M-Coat FT Teflon® Tape  
1 x 20 x 0.003in [25 x 500 x 0.08mm]

#### M-Coat J-3:

- 3 mixing dispensers [70g ea]
- 3 pieces M-Coat FT Teflon® Tape  
1 x 20 x 0.003in [25 x 500 x 0.08mm]

Teflon is a Registered Trademark of DuPont.



## Protective Coating



### FEATURES

- Outstanding moisture protection
- Easy to apply
- No cure required



**RoHS**  
COMPLIANT

### DESCRIPTION

Microcrystalline wax. Has very low water-vapor transmission rate. Attacked by most solvents. Coating thickness 0.015-0.06 in [0.4-1.5mm].

Excellent water-immersion coating. Poor mechanical protection. Often used as an intermediate coating.

### CHARACTERISTICS

#### Application Requirements:

Heat to at least +170°F [+75°C] to melt. For best wetting and sealing, heat specimen surface to at least +100°F [+45°C] before applying.

No cure required.

#### Operating Temperature Range:

0° to +150°F [-20° to +65°C].

#### Shelf Life:

No limit.

### PACKAGING OPTIONS

#### Kit:

5 tins (1oz [28g] ea)

#### Bulk:

1 package (5lb [2.25kg])

## Protective Coating



### FEATURES

- Easy to use
- Translucent
- Self-leveling
- Room-temperature cure

**RoHS**  
 COMPLIANT

### DESCRIPTION

Single-component 98%-solids RTV silicone rubber. Room-temperature cure (humidity-reactive). Completely non-corrosive. Forms tough, rubbery coating. Excellent properties. Translucent; permits full inspection of installation. Self-leveling; forms fairly thick coats 0.03-0.06 in [0.75-1.5mm].

Easy-to-apply general-purpose coating. Lab and field use. Low reinforcing effects. High-elongation capabilities. Good for short-term water immersion. Resists many chemicals. Bonds to contaminated surfaces for short-term tests; for best long-term protection, chemically clean surface and prime with *M-LINE* RTV Primer No. 1.

### CHARACTERISTICS

#### Cure Requirements:

Tack-free in approximately 2 hours.

Cure 24 hours at +75°F [+24°C], 50% RH for each 0.02-in [0.5-mm] thickness. Longer cure at lower humidity levels.

**Note:** Will not cure properly if coating is not exposed to atmosphere.

#### Operating Temperature Range:

**Short Term:** -100° to +600°F [-75° to +315°C].

**Long Term:** -65° to +500°F [-55° to +260°C].

#### Shelf Life:

Minimum 6 months at +75°F [+24°C].

### PACKAGING

#### Kit:

1 collapsible metal tube (3oz [85g])

#### Accessory:

4 brush-cap bottles (1oz [30ml] ea) RTV Primer No. 1

## Protective Coating



### FEATURES

- Easy to use
- Good mechanical protection
- Good cable anchor
- Room-temperature cure



**RoHS**  
COMPLIANT

### DESCRIPTION

Single-component 98%-solids RTV silicone rubber. Room temperature cure (humidity-reactive). Completely non-corrosive. Forms tough, rubbery coating. Excellent properties. Opaque gray coating of higher strength and toughness than 3140 RTV. Not self-leveling.

Easy-to-apply general-purpose coating. Lab and field use. Low reinforcing effects. High-elongation capabilities. Good

for short-term water immersion. Resists many chemicals. Bonds to contaminated surfaces for short-term tests; for best long-term protection, chemically clean surface and prime with *M-LINE* RTV Primer No. 1. Very thick coatings can be applied without sag or runoff. Tear strength much higher than 3140. Good cable anchor.

### CHARACTERISTICS

#### Cure Requirements:

Tack-free in approximately 2 hours.

Cure 24 hours at +75°F [+24°C], 50% RH for each 0.02-in [0.5-mm] thickness. Longer cure at lower humidity levels.

**Note:** Will not cure properly if coating is not exposed to atmosphere.

#### Operating Temperature Range:

**Short Term:** -100° to +600°F [-75° to +315°C].

**Long Term:** -65° to +500°F [-55° to +260°C].

#### Shelf Life:

Minimum 6 months at +75°F [+24°C].

### PACKAGING OPTIONS

#### Kit:

1 collapsible metal tube (3oz [85g])

#### Accessory:

4 brush-cap bottles (1oz [30ml] ea) RTV Primer No. 1

## Protective Coatings



### FEATURES

- Thin, hard coating
- Good electrical and mechanical protection
- Good leadwire anchor
- Also used as an adhesive



**RoHS**  
COMPLIANT

### DESCRIPTION

Two-component 100%-solids epoxy systems. Primarily used as an adhesive. Often used as protective coatings because of low vapor-transmission rate. AE-15 is superior but requires heat cure. Single coating thickness 0.005-0.015in [0.1–0.4mm].

Primarily used where a thin hard coating is required to resist water immersion for short time. Good electrical/mechanical protection where high velocity fluids are present and minimum disturbance to flow is necessary. Good leadwire anchor. Often used as precoat for sealing concrete.

### CHARACTERISTICS

#### Cure Requirements:

AE-10 minimum cure 6 hours at +75°F [+24°C]; AE-15 is 6 hours at +125°F [+50°C]. To accelerate cure at higher temperatures, see cure schedules for M-Bond AE-10 and M-Bond AE-15.

AE-10 mixed pot life 15-20 minutes; AE-15 is 1-1/2 hours at +75°F [+24°C].

#### Operating Temperature Range:

–100° to +200°F [–75° to +95°C].

#### Shelf Life:

Minimum 12 months at +75°F [+24°C]; or 18 months at +40°F [+5°C].

### PACKAGING OPTIONS

#### Kit:

6 mixing jars AE Resin [10g] ea  
1 bottle Curing Agent 10 or 15 (1/2oz [15ml])

#### Bulk:

1 bottle AE Resin [200g]  
1 bottle Curing Agent 10 [40g] or  
1 bottle Curing Agent 15 [25g]

## Protective Coating



### FEATURES

- Excellent chemical, electrical and mechanical properties
- Thin, hard coating
- Excellent in transducer service
- Also used as an adhesive
- Elevated-temperature cure



**RoHS**  
COMPLIANT

### DESCRIPTION

Solvent-thinned (MEK and xylene) single-component epoxy resin compound. Primarily used as an adhesive. Cured coating 0.002-0.01in [0.05-0.25mm] thick.

Provides excellent chemical, electrical, and mechanical properties when fully cured. Film is hard, with high heat-distortion temperature. Excellent in transducer service.

### CHARACTERISTICS

#### Cure Requirements:

Minimum cure 2 hours at +325°F [+160°C]. Preferred cure 2 hours at +375°F [+190°C].

#### Operating Temperature Range:

**Short Term:** -452° to +400°F [-269° to +205°C].

**Long Term:** -452° to +300°F [-269° to +150°C].

#### Shelf Life:

Minimum 9 months at +75°F [+24°C]; or 18 months at +40°F [+5°C].

### PACKAGING

#### Kit:

4 brush-cap bottles (1oz [30ml] each)

#### Single Bottle:

1 brush cap bottle [30ml] premixed.

## Protective Coating



### FEATURES

- Excellent mechanical and chemical protection.
- Good leadwire anchor.
- Also used as an adhesive
- Elevated-temperature cure.

### DESCRIPTION

Two-component 100%-solids, elevated-temperature-curing epoxy system. Very high viscosity. Generally applied with a spatula, and can be contoured to the surface. Coating thickness 0.005-0.03in [0.1-0.75mm].

Commonly used for mechanical protection at elevated temperatures and in highly reactive hot synthetic oils such as in aircraft engines. Very good leadwire anchor to high g-fields (see Application Note TT-601, VRH-AN0601). Can be used to fill slots or grooves. Can be machined after cure.

### CHARACTERISTICS

#### Cure Requirements:

Cure 6 hours at +250°F [+120°C],  
or 3 hours at +300°F [+150°C],  
or 2 hours at +350°F [+175°C],  
or 1 hour at +400°F [+205°C].

Mixed pot life 10 hours at +75°F [+24°C]; increased by refrigeration, indefinite by freezing.

#### Operating Temperature Range:

**Short Term:** -100° to +500°F [-75° to +260°C].  
**Long Term:** -100° to +400°F [-75° to +205°C].

#### Shelf Life:

Minimum 6 months +75°F [+24°C];  
refrigeration recommended.

### PACKAGING

#### Kit:

3 mixing jars ea Resin and Hardener [45g].

## Protective Coating



### FEATURES

- No cure required
- Quick application
- Excellent mechanical protection
- Resistant to water penetration



**RoHS**  
COMPLIANT

### DESCRIPTION

Single-component butyl rubber patch with vinyl carrier. Quick application, even at low temperature. Excellent mechanical protection. Resistant to water penetration.

### CHARACTERISTICS

**Operating Temperature Range:**

-20° to +200°F [-30° to +95°C].

**Shelf Life:**

Minimum 1 year at +75°F [+24°C].

**Cure Requirements:**

None

### PACKAGING OPTIONS

**Kit:**

5 sheets 4 x 6 x 0.1 in [100 x 150 x 2.5mm]

## Protective Coating



### FEATURES

- Flexible moisture protection
- Ready to use immediately after application. No curing required.



**RoHS**  
COMPLIANT

### DESCRIPTION

Single-component soft paste wax. General-purpose moisture protection.

### CHARACTERISTICS

**Operating Temperature Range:**

-100° to +150°F [-73° to +66°C].

**Shelf Life:**

Minimum 1 year

### PACKAGING

**Kit:**

1-lb [454-g] can



## Protective Coating

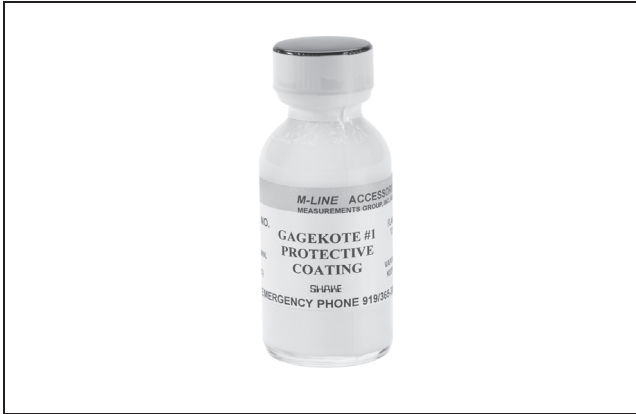

### OTHER M-LINE COATINGS COMPATIBLE WITH GAGEKOTE #1:

- Gagekote #5
- Epoxylite #813



**RoHS**  
COMPLIANT

### DESCRIPTION

Solvent-thinned (toluene) synthetic resin. Often used as a precoat for Gagekote #5, and Epoxylite #813. Resistant to

moisture and offers a wide operating temperature range. Provides limited mechanical protection. Convenient to use.

### CHARACTERISTICS

**Operating Temperature Range:**  
-320° to +850°F [-195° to +455°C].

**Shelf Life:**  
Minimum 2 years at +75°F [+24°C].

**Cure Requirements:**

Single coat air dry for 15 minutes at +75°F [+24°C]. Prior to encapsulation by other coatings, air dry 4 hours at +75°F [+24°C] or 30 minutes at +150°F [+65°C] to prevent solvent entrapment.

### PACKAGING OPTIONS

**Kits:**

- 1 brush-cap bottle [1oz/30ml]
- 12 brush-cap bottles [1oz/30ml each]
- 1 bottle [8oz/240ml each]

## Protective Coating



### OTHER M-LINE COATINGS COMPATIBLE WITH GAGEKOTE #5:

- M-Coat W-1 Wax
- M-Coat B



RoHS  
COMPLIANT

### DESCRIPTION

Two-part 100%-solids modified polysulfide epoxy. Good for general laboratory and field use. Prime leadwire insulation with M-Coat B. Excellent mechanical protection. Resistant to

salt water, gasoline, hydrocarbon oils, most acids, alkalines, and solvents.

### CHARACTERISTICS

#### Operating Temperature Range:

-90° to +250°F [-68° to +120°C].

#### Shelf Life:

Minimum 1 year at +75°F [+24°C].

#### Cure Requirements:

Air dry 6 hours at +75°F [+24°C] or 1 hour at +150°F [+66°C].

### PACKAGING OPTIONS

#### Kits:

4 jars Part A [1.5oz/45gm]

4 jars Part B [0.5oz/15gm]

1 jar Part A [11oz/340gm]

1 jar Part B [3.5oz/114gm]

## Protective Coating



### OTHER M-LINE COATINGS COMPATIBLE WITH GAGEKOTE #8:

- Gagekote #5
- Gagekote #7



**RoHS**  
COMPLIANT

### DESCRIPTION

Single component transparent acrylic coating. Recommended as an under or over coating for Gagekote #5, and Gagekote #7. Good for anchoring intra-bridge wiring in high performance transducers. Extremely flexible and

resistant to direct water immersion, mild solvents and chemicals. Film thickness of 0.005 - 0.01 in. [0.1 - 0.25mm] per coat.

### CHARACTERISTICS

**Operating Temperature Range:**  
-100° to +270°F [-75° to +130°C].

**Shelf Life:**  
Minimum 1 year at +75°F [+24°C].

**Cure Requirements:**  
Single coat air dry for 10 minutes at +75°F [+24°C]. Prior to encapsulation by other coatings, air dry 4 hours at +75°F [+24°C] or 30 minutes at +150°F [+65°C] to prevent solvent entrapment.

### PACKAGING OPTIONS

**Kits:**  
1 brush-cap bottle [1oz/30ml]  
12 brush-cap bottles [1oz/30ml each]  
1 bottle [8oz/240ml]  
1 bottle [32oz/960ml]

## Protective Coating



### OTHER M-LINE COATINGS COMPATIBLE WITH GAGEKOTE #11:

- H-Cement
- Denex #2 Ceramic Cement
- PBX Cement



**RoHS**  
COMPLIANT

### DESCRIPTION

Single-component clear coating. High temperature protective coating, when cured, seals and protects free filament strain gage installations. Must be reapplied after

exposure to temperature excursions above +900°F [+482°C].

### CHARACTERISTICS

**Operating Temperature Range:**

−452° to +900°F [−269° to +482°C].

**Shelf Life:**

Minimum 1 year at +75°F [+24°C].

**Cure Requirements:**

Air dry 2 hours at +75°F [+24°C], followed by 1 hour at +350°F [+175°C].

### PACKAGING OPTIONS

**Kit:**

1 brush-cap bottle [1oz/30ml]



# Strain Gage Application Kits

## Contents

BAK-200.....	82
CEA-200.....	82
GAK-2-200 .....	82
GAK-2-AE-10 .....	82
GAK-2-610 .....	82
MAK-1 .....	83

## Strain Gage Application Kits



### FEATURES

- GAK-2 Series Kits include all materials necessary to immediately start making strain gage installations for routine applications.
- Kit supplies and materials are provided in a tool box for convenience and portability.
- BAK-200 kit contains essential materials for M-Bond 200 installations, packaged in a cardboard box.
- CEA-200 kit contains CEA strain gages and materials needed for installation of the gages. Perfect for educators and novice strain gage users.

### KIT CONTENTS

GAK-2-200	GAK-2-AE-10	GAK-2-610
M-Bond 200, 1 kit CSM Degreaser, 1 can MCA-1 M-Prep Conditioner A, 1 btl MN5A-1 M-Prep Neutralizer 5A, 1 btl SCP-1 220 grit, 1 roll SCP-2 320 grit, 1 roll SCP-3 400 grit, 1 roll CSP-1 Cotton Swabs, 1 pkg GSP-1 Gauze Sponges, 1 pkg PCT-2M Gage Installation Tape, 1 roll PDT-1 Paper Drafting Tape, 1 roll 361A-20R-25 Solder, 1 roll, 25 ft [7.6 m] Rosin Solvent, 1 oz [30 ml] CPF-AST Bondable Terminals, 1 box 326-DFV, 3-Conductor Leadwire, 100 ft [30 m] M-Coat A, 1 oz [30 ml] 134-AWP Solid Copper Wire, 500 ft [150 m] Plastic Tool Box	M-Bond AE-10, 1 kit CSM Degreaser, 1 can MCA-1 M-Prep Conditioner A, 1 btl MN5A-1 M-Prep Neutralizer 5A, 1 btl SCP-1 220 grit, 1 roll SCP-2 320 grit, 1 roll SCP-3 400 grit, 1 roll CSP-1 Cotton Swabs, 1 pkg GSP-1 Gauze Sponges, 1 pkg PCT-2M Gage Installation Tape, 1 roll PDT-1 Paper Drafting Tape, 1 roll 361A-20R-25 Solder, 1 roll, 25 ft [7.6 m] Rosin Solvent, 1 oz [30 ml] CPF-AST Bondable Terminals, 1 box 326-DFV, 3-Conductor Leadwire, 100 ft [30 m] M-Coat A, 1 oz [30 ml] 134-AWP Solid Copper Wire, 500 ft [150 m] SGP-2 Silicone Rubber, 1 pc HSC-1 No. 1 Spring Clamp, 1 ea HSC-2 No. 2 Spring Clamp, 1 ea Plastic Tool Box	M-Bond 610, 1 kit CSM Degreaser, 1 can MCA-1 M-Prep Conditioner A, 1 btl MN5A-1 M-Prep Neutralizer 5A, 1 btl SCP-1 220 grit, 1 roll SCP-2 320 grit, 1 roll SCP-3 400 grit, 1 roll CSP-1 Cotton Swabs, 1 pkg GSP-1 Gauze Sponges, 1 pkg MJG-2 Mylar® Tape, 1 roll PDT-1 Paper Drafting Tape, 1 roll 361A-20R-25 Solder, 1 roll, 25 ft [7.6 m] Rosin Solvent, 1 oz [30 ml] CPF-AST Bondable Terminals, 1 box 326-DFV, 3-Conductor Leadwire, 100 ft [30 m] M-Coat C, 1 oz [30 ml] 134-AWP Solid Copper Wire, 500 ft (150 m) SGP-2 Silicone Rubber, 1 pc HSC-1 No. 1 Spring Clamp, 1 ea HSC-2 No. 2 Spring Clamp, 1 ea TFE-1 Teflon® Film, 1 roll Plastic Tool Box
BAK-200	CEA-200	
M-Bond 200 Adhesive, 1 oz [28 g] M-Bond 200 Catalyst, 1 btl CSP-1 Cotton Swabs, 1 pkg PCT-2M Gage Installation Tape, 1 roll CSM Degreaser, 1 can GSP-1 Gauze Sponges, 1 pkg MCA-1 M-Prep Conditioner A, 1 btl MN5A-1 M-Prep Neutralizer 5A, 1 btl SCP-2 320 grit, 1 roll SCP-3 400 grit, 1 roll	CEA-13-250UW-350/P2, 5 pcs M-Bond 200 Adhesive, 2 @ 2 grams M-Bond 200 Catalyst, 1/2 oz [30 ml] CSP-1 Cotton Swabs, 20 ea GSP-1 Gauze Sponges, 60 ea PCT-2M Tape, 1 roll GC-6 Alcohol, 4 oz MCA-1 M-Prep Conditioner A, 1 btl MN5A-1 M-Prep Neutralizer 5A, 1 btl SCP-2 Silicon-Carbide Paper, 20 in SCP-3 Silicon-Carbide Paper, 20 in Aluminum Beams, 2 ea Practice Beams, 2 ea DP-1 Drafting Pencil, 1 ea Practice Patterns, 25 pcs	Mylar And Teflon are Registered Trademarks of DuPont.

## Master Strain Gage Application Kit

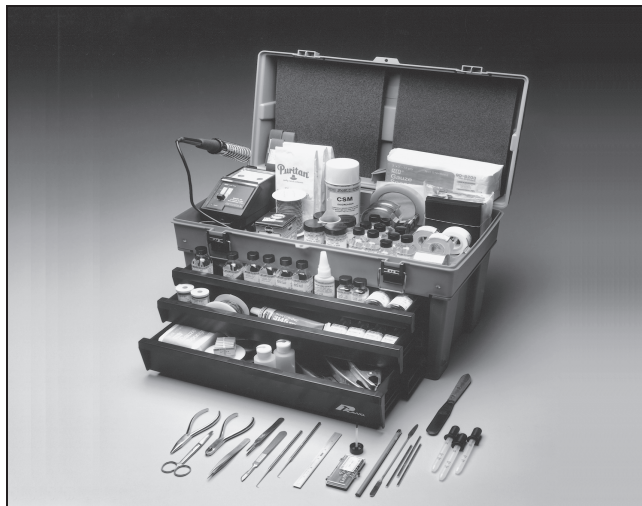

### FEATURES

- Includes all supplies and special tools for making a wide range of strain gage installations for both laboratory and field applications.
- Successfully complete any organic strain gage installation for operation from  $-452^{\circ}$  to  $+500^{\circ}\text{F}$  [ $-269^{\circ}$  to  $+260^{\circ}\text{C}$ ].
- All materials, including complete instructions, conveniently packaged in a molded, crush-proof, copolymer toolbox.

### MAK-1 KIT CONTENTS

#### Surface Preparation Materials:

CSM Degreaser, 1 can  
MCA-1, M-Prep Conditioner A, 1 bottle  
MN5A-1, M-Prep Neutralizer 5A, 1 bottle  
Silicon-Carbide Paper: 220, 320, 400 grit, one 10-ft [3-m] roll each  
CSP-1, Cotton Swab, 4 packages  
GSP-1, Gauze Sponges, 2 packages  
RSK-1, Rosin Solvent, two 1-oz [30-ml] bottles

#### Application Tools:

SSH-1, Surgical Shears  
SSC-1, Surgical Scalpel and Blade  
SSC-2, Scalpel Blades (5)  
BTW-1, Tweezers  
STW-1, Tweezers  
DP-1, 4-H Drafting Pencil  
DWC-1, Diagonal Cutters  
DPR-1, Dental Probe (2)  
NNP-1, Needle-Nosed Pliers  
SSS-1, Steel Scale  
SPT-1, Spatula  
SPT-2, Spatula

#### Hardware:

PCT-2M, Gage Installation Tape, 2 dispenser rolls  
PDT-1, Drafting Tape, 2 dispenser rolls  
MJG-2, Mylar® Tape, 1 roll  
HSC-1, No. 1 Spring Clamps (4)  
HSC-2, No. 2 Spring Clamps (2)  
HSC-3, No. 3 Spring Clamp (1)  
TFE-1, Teflon® Film, 1 roll  
GT-14, Pressure Pads & Plates Kit

#### Adhesives:

M-Bond 200, 1 kit  
M-Bond AE-10, 1 kit  
M-Bond 610, 1 kit

#### Soldering Supplies:

M8S-1-XXX, Mark VIII Soldering Unit (specify 115 or 230 Vac)  
361A-20R, 1 lb [0.45 kg]  
361A-20R-25, 1 roll  
450-20S-25, 1 roll  
570-28R-20, 1 roll  
FAR-1, M-Flux AR, 1 kit  
CPF-AST, Terminal Strip Assortment, 1 box

#### Leadwire:

134-AWP, 100 ft [30-m]  
126-DWV: Red, White, Black, Green,  
one 100-ft [30 m] roll each  
326-DFV, 100 ft [30 m]  
130-FWT: Red, White, Black, Green,  
one 50-ft [15 m] roll each

#### Protective Coatings:

M-Coat A, two 1-oz [30-ml] bottles  
M-Coat B, two 1-oz [30-ml] bottles  
M-Coat C, 1-oz [30-ml] bottle  
M-Coat D, 1-oz [30-ml] bottle  
M-Coat F, 1 kit  
3145 RTV Silicone Rubber, 3-oz [85-g] tub

Mylar and Teflon are Registered Trademarks of DuPont.

**Reference:** An adhesive selection table is provided in the "M-Bond Strain Gage Adhesives."







# Precision Resistors

Epoxy Cased

•

Wirewound

•

Hermetically Sealed

## Contents

Specification and Selection Card.....	86
---------------------------------------	----

### Shunt-Calibration

W-599880-02 .....	87
W-119880-02 .....	87
S-59880-01 .....	87
S-29880-01 .....	87
S-19880-01 .....	87
S-14880-01 .....	87
S-11880-01 .....	87
S-5880-01 .....	87
W-349650-02 .....	87
W-174650-02 .....	87
S-87150-01 .....	87
S-57983-01 .....	87
S-43400-01 .....	87
S-34650-01 .....	87
S-17150-01 .....	87
W-999000-02 .....	87
W-499000-02 .....	87
W-249000-02 .....	87
W-165666-02 .....	87
W-124000-02 .....	87
S-99000-01 .....	87
S-49000-01 .....	87

### Bridge Completion, Single

S-50-01 .....	87
S-60-01 .....	87
S-100-01 .....	87
S-120-01 .....	87
S-175-01 .....	87
S-240-01 .....	87
S-350-01 .....	87
S-500-01 .....	87
S-1000-01 .....	87
S-2000-01 .....	87
S-5000-01 .....	87
H-100-01 .....	87
H-120-01 .....	87
H-350-01 .....	87
H-1000-01 .....	87

## Specifications and Selection Charts

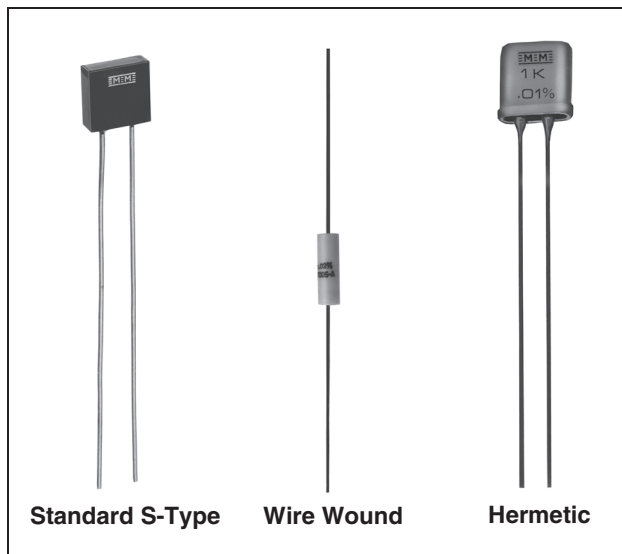

Fixed resistors have two primary uses in strain gage circuits: shunt calibration of strain-measuring instrumentation, and bridge completion. For shunt calibration, a fixed resistor is temporarily shunted across a bridge arm to produce a known resistance change in the bridge circuit. The resulting instrument indication is then compared to the calculated strain corresponding to the resistance change. For bridge-completion applications, a fixed resistor may be used in the adjacent arm of the bridge to complete the external half-bridge circuit when a single strain gage is connected in a quarter-bridge arrangement.

In each of these applications, the accuracy of the strain measurement is affected, directly or indirectly, by the accuracy and stability of the fixed resistor(s) used in the circuit. It is important, therefore, that only precision, high-stability resistors be selected for these purposes.

PRECISION RESISTOR SPECIFICATIONS		
Standard S-Type (Prefix "S")	Wire-Wound (Prefix "W")	Hermetic (Prefix "H")
<p>Noted for long-term stability and low temperature-coefficient-of-resistance. Used for shunt calibration (below 100,000Ω) and bridge completion.</p> <p><b>Size:</b> 0.295 x 0.320 x 0.10in [7.5 x 8.1 x 2.5mm].</p> <p><b>Temperature Coefficient:</b> ±0.6 ppm/°F; +32° to +140°F [±1 ppm/°C; 0° to +60°C].</p> <p><b>Stability:</b> 25 ppm/year max. drift.</p> <p><b>Wattage:</b> 0.3 at +75°F [+24°C].</p> <p><b>Leadwires:</b> 22 AWG tinned copper.</p> <p><b>Construction:</b> Encapsulated in epoxy case for use in normal laboratory environment.</p>	<p>For high-value shunt resistance requirements (above 100,000Ω).</p> <p><b>Size:</b> 0.25 in dia. x 0.75in long [6.4 x 19.1mm].</p> <p><b>Temperature Coefficient:</b> ±12 ppm/°F; +32° to +140°F [±20 ppm/°C; 0° to +60°C].</p> <p><b>Stability:</b> 30 ppm/year max. drift.</p> <p><b>Wattage:</b> 0.3 at +75°F [+24°C].</p> <p><b>Leadwires:</b> 20 AWG tinned copper.</p> <p><b>Construction:</b> Noninductive windings. Encapsulated for use in normal laboratory environment.</p>	<p>Best long-term stability under adverse environmental conditions. Premium resistors used for bridge completion where highest accuracy and stability are required.</p> <p><b>Size:</b> 0.4 in square x 0.15in thick [10 x 4mm].</p> <p><b>Temperature Coefficient:</b> ±0.6 ppm/°F; +32° to +140°F [±1 ppm/°C; 0° to +60°C].</p> <p><b>Stability:</b> 5 ppm/year max. drift.</p> <p><b>Wattage:</b> 0.25 at +75°F [+24°C].</p> <p><b>Leadwires:</b> 22 AWG tinned copper.</p> <p><b>Construction:</b> Hermetically sealed in metal case. Excellent long-term stability.</p>

## Specifications and Selection Charts

<b>SHUNT-CALIBRATION RESISTORS</b>				
	Order No.	Resistance in Ohms	Tolerance in %	Equivalent Microstrain
<b>For 120Ω Gage Circuit</b>	W-599880-02	599 880	±0.02	100
	W-119880-02	119 880	±0.02	500
	S-59880-01	59 880	±0.01	1000
	S-29880-01	29 880	±0.01	2000
	S-19880-01	19 880	±0.01	3000
	S-14880-01	14 880	±0.01	4000
	S-11880-01	11 880	±0.01	5000
	S-5880-01	5 880	±0.01	10,000
<b>For 350Ω Gage Circuit</b>	W-349650-02	349 650	±0.02	500
	W-174650-02	174 650	±0.02	1000
	S-87150-01	87 150	±0.01	2000
	S-57983-01	57 983	±0.01	3000
	S-43400-01	43 400	±0.01	4000
	S-34650-01	34 650	±0.01	5000
	S-17150-01	17 150	±0.01	10,000
<b>For 1000Ω Gage Circuit</b>	W-999000-02	999 000	±0.02	500
	W-499000-02	499 000	±0.02	1000
	W-249000-02	249 000	±0.02	2000
	W-165666-02	165 666	±0.02	3000
	W-124000-02	124 000	±0.02	4000
	S-99000-01	99 000	±0.01	5000
	S-49000-01	49 000	±0.01	10,000

The "Equivalent Microstrain" column shows the true compression strain simulated by shunting each calibration resistor across an active strain gage arm of the exact indicated resistance, based on a circuit gage factor setting of 2.000.

<b>BRIDGE COMPLETION RESISTORS</b>	
Circuit and Bridge Completion Tolerance ±0.01%	
Order No.	Resistance in Ohms
S-50-01	50
S-60-01	60
S-100-01	100
S-120-01	120
S-175-01	175
S-240-01	240
S-350-01	350
S-500-01	500
S-1000-01	1000
S-2000-01	2000
S-5000-01	5000
H-100-01	100
H-120-01	120
H-350-01	350
H-1000-01	1000

**Note:** Shunt-calibration resistors are chosen to accurately simulate resistance change in a strain gage subjected to specified levels of compressive strain. Strain indicators generally produce a linear output with a fully active half-bridge or full-bridge input circuit, and will be slightly in error when a single active arm is used. The same nonlinearity occurs whether the gage is actually strained in compression or simulated by shunting the gage with the corresponding calibration resistor. See Tech Note TN-514, "Shunt Calibration of Strain Gage Instrumentation."





# Bridge Completion Modules

## Contents

MR1-350-127 .....	90
MR1-10C-129.....	90
MR1-350-130 .....	90
MR2-350-128 .....	90

## Information and Selection Chart

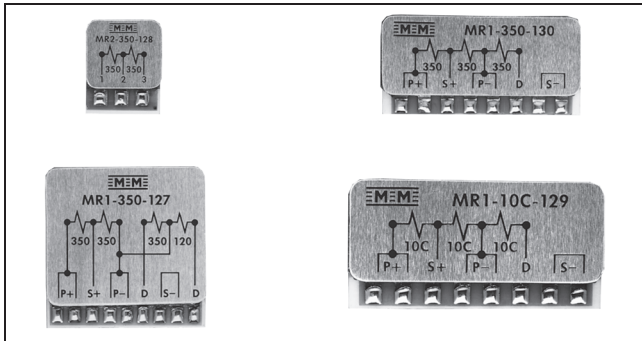

Strain gage instrumentation is readily available with built-in bridge completion resistors and “dummy” gages to accept quarter- and half-bridge strain gage input circuits. However, if the instrumentation at hand is not provided with these components, or if the measurement application does not permit their use, external bridge completion must be provided, and MR-Series Bridge Completion Modules can be an excellent choice in these applications.

MR-Series Bridge Completion Modules employ metal-foil resistance elements, bonded to a dense ceramic substrate. The resistance elements are specially processed to “match” the thermal expansion coefficient of the ceramic, resulting in a very low resistance temperature coefficient equivalent to  $\pm 0.15 \mu\epsilon/\text{F}$  [ $\pm 0.27 \mu\epsilon/\text{C}$ ] for the half-bridge circuits, and  $\pm 0.35 \mu\epsilon/\text{F}$  [ $\pm 0.63 \mu\epsilon/\text{C}$ ] for the dummy gages, over a

temperature range from 0° to +200°F [−18° to +95°C]. Maximum operating temperature range is −50° to +250°F [−45° to +120°C].

Each module is covered with a special environmental protection system to ensure long-term stability. A rugged aluminum overlay, embossed with a wiring diagram for easy terminal identification, affords additional protection, and in many applications no supplementary environmental protection is required. Each module is provided with foam tape for easy attachment to the test-part surface or at the instrumentation site, and tinned, heavy copper terminals facilitate attachment of up to 22-gage [0.64mm dia.] leadwires.

Completing the bridge circuit at the strain gage site provides for a symmetrical, balanced leadwire system between the strain gage circuit and the instrumentation. This can reduce effects of noise pickup in the leadwire system in some environments. Where switch contacts, slip rings, or other mechanical connections are employed between the strain gages and measuring instrumentation, or when leadwires will be periodically disconnected from the measuring instrument, accuracy can be improved by completing the bridge at the measurement site. Bridge completion modules can be designed to meet special circuit requirements. Contact our Applications Engineering Department for a detailed discussion of your special needs.

CHARACTERISTICS		
Module Type & Features	Bridge Excitation (Volts)	
	Recommended	Maximum
<b>MR1-350-127:</b> Provides a precision 350Ω half bridge as well as 120Ω and 350Ω dummy gages. Recommended for use with half-bridge strain gage circuits of any resistance value, or with 120Ω or 350Ω three-wire quarter-bridge circuits. Size (including foam tape): 1 x 1 x 0.2in [25 x 25 x 5mm]. Weight: 6g.	0.5 – 15V 0.5 – 25V	20V (D120) 35V (D350)
<b>MR1-10C-129:</b> Provides a precision 1000Ω half bridge and a 1000Ω dummy gage. Recommended for use with half-bridge strain gage circuits of any resistance value, or with 1000Ω quarter-bridge circuits. High resistance extends battery life in battery-powered instrumentation, reduces strain gage self-heating, and permits higher bridge excitation voltage to improve signal-to-noise ratio. Size (including foam tape): 1.2 x 0.6 x 0.2in [30 x 15 x 5mm]. Weight: 4g.	0.5 – 30V	40V
<b>MR1-350-130:</b> Provides a precision 350Ω half bridge and a 350Ω dummy gage. Recommended for use with half-bridge strain gage circuits of any resistance value, or with 350Ω three-wire quarter-bridge circuits. Size (including foam tape): 1.2 x 0.6 x 0.2in [30 x 15 x 5mm]. Weight: 4 .	0.5 – 18V	25V
<b>MR2-350-128:</b> Provides a precision 350Ω half bridge in a compact size for use with half-bridge strain gage circuits. Small size makes it ideal for attachment at the strain gage site on the test part in many applications. Size (including foam tape): 0.5 x 0.7 x 0.2in [13 x 18 x 5mm]. Weight: 2g.	0.4 – 18V	25V

Half-bridge circuits in each module type are balanced to within  $\pm 0.005\%$ . Resistance tolerance on each dummy gage is  $\pm 0.02\%$ .



# Special-Purpose Equipment

## Contents

Model 1300 Gage Installation Tester .....	92
Model 700 Portable Strain Gage Welding and Soldering Unit...	94

## Gage Installation Tester



### FEATURES

- A compact, battery-powered instrument used to verify the electrical quality of a strain gage installation BEFORE it is placed in service
- Reads with the push of a button - no warm-up
- Reads insulation resistance (leakage) to 20,000 megohms with 15Vdc
- Measures deviation of installed gage resistance from precise standards to a resolution of 0.02 percent
- Ohmmeter scale for troubleshooting questionable installations
- Verifies the complete gage circuit, including leadwires

### DESCRIPTION

Two of the most important measurements used to verify the quality of a strain gage installation are insulation resistance (leakage to ground) and shift in gage resistance due to installation procedures. While these two measurements are not a complete guarantee of eventual proper strain gage performance, any installation that produces questionable values should not be relied upon where accuracy of results is necessary.

For example, a voltage difference between the specimen and strain gage frequently exists. A low insulation resistance will permit this voltage differential to introduce extraneous signals during strain measurement.

Several sources of variations in insulation resistance and shifts in gage resistance are:

- Insulation resistance in excess of 20,000 megohms should be expected for foil strain gages when installed under laboratory conditions. A value of 10,000 megohms should be considered minimum. A reading below this value generally indicates trapped foreign matter, moisture, residual flux or backing damage due to soldering, as well as incomplete solvent evaporation from an overcoating.

- Deterioration of the insulation resistance with time may be an indication of an improperly coated installation.
- At higher test temperatures, particularly above +300°F [+150°C], it is normal to expect lesser values. Ten megohms is considered to be the lower allowable value.
- Shifts in gage resistance during installation should not normally exceed 0.5% when using room-temperature-curing adhesives. Resistance shifts greater than 0.5% generally indicate damage to the gage due to improper handling or clamping. However, strain gages installed using elevated-temperature-curing adhesives may exhibit greater shifts in resistance due to adhesive lock-up at elevated temperatures (difference in linear coefficient of thermal expansion between the strain gage and specimen). These shifts will vary depending upon the specific cure temperature and materials used. The shifts should never exceed 2% and should be uniform within 0.5%.



Gage Installation Tester

**SPECIFICATIONS**

**Input Circuits:**

**Gages:** Three-wire quarter bridge (120Ω and 350Ω) and half bridge. Other value quarter bridges using customer's reference, at readily accessible panel terminals.

**As ohmmeter:** Two leads (500Ω and 500MΩ midscale).

**Input Leads:**

4-ft [1.2m] 4-conductor AWG #26 [0.4-mm diameter] twisted Teflon®-insulated cable supplied (with ground clip and three tinned leads).

**Meter:**

3.5-in size (3.00-in [76-mm] scale length) with mirror. Tracking accuracy ±1% full range.

**Mode Switch:**

Five momentary push buttons: battery check, ±5% deviation, ±1% deviation, gage resistance (ohms), and insulation resistance (megohms).

**Deviation Mode:**

Two ranges, ±1% and ±5%, F.S. (50 graduations either side of zero).

**Accuracy:**

1% range: 0.04% ΔR (2 meter graduations)

5% range: 0.2% ΔR (2 meter graduations)

**Excitation:** 1.0Vdc per gage.

**Insulation Resistance Mode:**

Graduated 5MΩ to 20,000MΩ (500MΩ mid-scale).

**Accuracy:** 1 scale division.

**Test Voltage:** 15Vdc open circuit.

**Ohm Mode:**

Graduated 5Ω to 20kΩ (500Ω mid-scale).

**Accuracy:** 1 scale division.

**Test Voltage:** 2Vdc open circuit (0.4Vdc @ 120Ω).

**Environmental:**

+15° to +125°F [-10° to +50°C]; up to 80% relative humidity, non-condensing.

**Size:**

Aluminum case (separable lid) 5 H x 7 W x 5 D in with lid [125 x 180 x 126mm].

**Weight:**

3.6lb [1.6kg] with batteries.

**Power Supply:**

Four 9V NEDA 1604 batteries (Eveready® 216 or equivalent).

**Life:** Will fully test 1000-5000 installations.

*All specifications are nominal or typical @ +23°C unless noted.*

Teflon is a Registered Trademark of DuPont

Eveready is a Registered Trademark of Eveready Battery Co Inc.

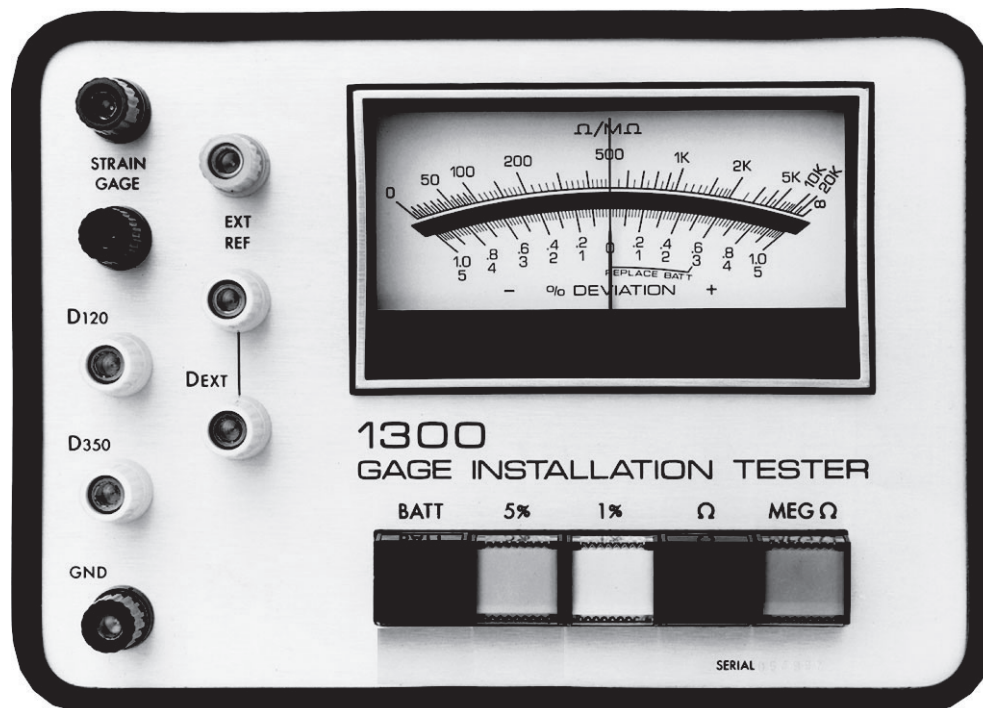

## Portable Strain Gage Welding and Soldering Unit



### FEATURES

- Separate visual and audible indicators monitor welder status - Weld energy is continuously adjustable from 3 to 50 joules, making the Model 700 an excellent choice for installing weldable strain gages and temperature sensors, as well as small thermocouples and light-gauge metal.
- Supplied with a lightweight soldering pencil - A front-panel control adjusts soldering tip temperature for a wide range of soldering applications in the field or in the laboratory.
- “Low-battery” light to warn the user when the internal, sealed lead-acid battery requires charging - A battery charger is included to provide for full battery charge with no danger of overcharging. Indicator lights monitor battery charge rate.
- Convenient storage space for cables, battery charger and instruction manual.

### GENERAL SPECIFICATIONS

**Overall Size:**

9 L x 9 W x 9-3/4 H-in [230 x 230 x 250mm].

**Weight:**

21lb [9.5kg].

**Power for Recharging:**

115Vac or 230Vac, 50-60Hz. Uses external AC transformer (provided).

**Operating and Storage Temperature Range:**

0° to +120°F [-20° to +50°C].

### WELDING SPECIFICATIONS

**Weld Energy Range:**

3 to 50 joules, continuously adjustable by front-panel control. Maximum open-circuit voltage less than 25Vdc.

**Maximum Weld Repetition Rate:**

20 per minute at 30 joules, typical.

**Number of Welds per Battery Charge:**

Approximately 2000 at weld energy setting of 30 joules. This is equivalent to 40 Micro-Measurements weldable gage installations.

**Battery Charge Time: (from full discharge)**

12 hours to 75% full charge; 18 hours to full charge.

**Battery:**

One sealed, rechargeable lead-acid (non-liquid) type, 12 volt, 5 ampere-hour.

**Welding Probe:**

Manually fired with trigger control and “steady-rest.”

**Welding Cables:**

Two 5 ft [1.5m], fully flexible.

**Weld Energy Monitor:**

Calibrated front-panel control with READY and WAIT indicators; audible indication selectable.

Portable Strain Gage Welding and Soldering Unit

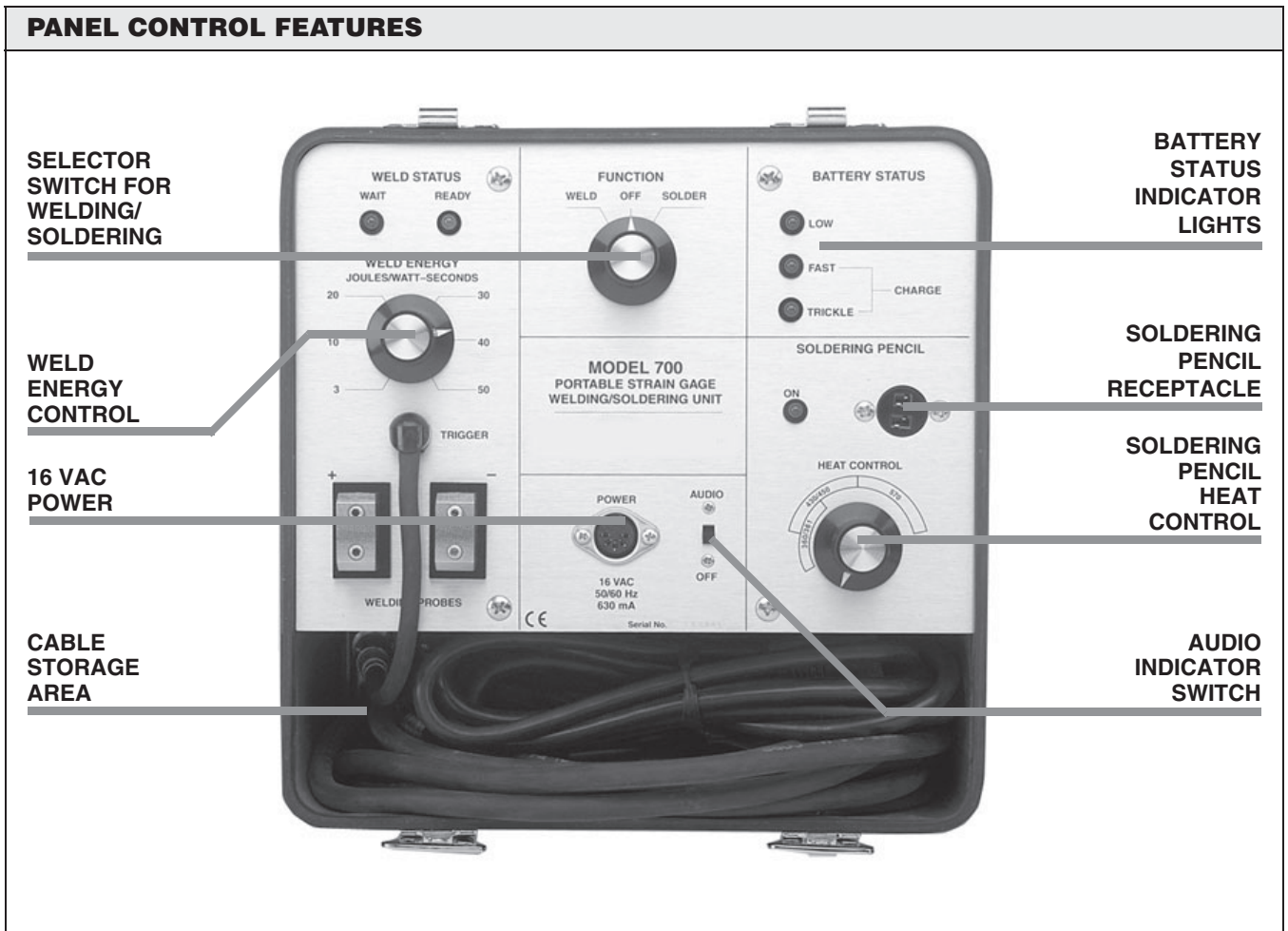

**SOLDERING SPECIFICATIONS**

**Temperature Control:**

Continuously variable with bands indicating melting range of solders.

**Soldering Pencil:**

1.1 oz [31 gm], rated at 25 watts, 12 volt operation. Tip temperature adjustable from +200° to +900°F [+90° to +480°C].

**Soldering Duration:**

4 hours using +361°F [+183°C] melting point solders (with initial full charge).

**Accessory:**

**Model 700-A103 Spot Welding Probe Set:**

Recommended for spot welding instrument leadwires to ZC-Series high-temperature gage ribbons.

All specifications are nominal or typical at +23°C unless noted.





# Technical Support

## Contents

Technical Publications .....	98
Application Engineering .....	98
Technical Training .....	99

## Technical Support

In the previous sections of this catalog, we have described the necessary tools, materials, and supplies required for successful strain gage installation. Once the proper selection of application accessories is made, the next and most important step in installing the gage is the application technique itself. To this end, Micro-Measurements offers a full range of technical support that includes an extensive set of instructional publications, regularly scheduled training

programs on the procedures and techniques for making high-quality strain gage installations, and self-teaching aids to help trainees quickly gain skill and proficiency in application techniques. Additionally, we maintain a full-time Applications Engineering staff to assist the customer with any particular strain gage installation problem.

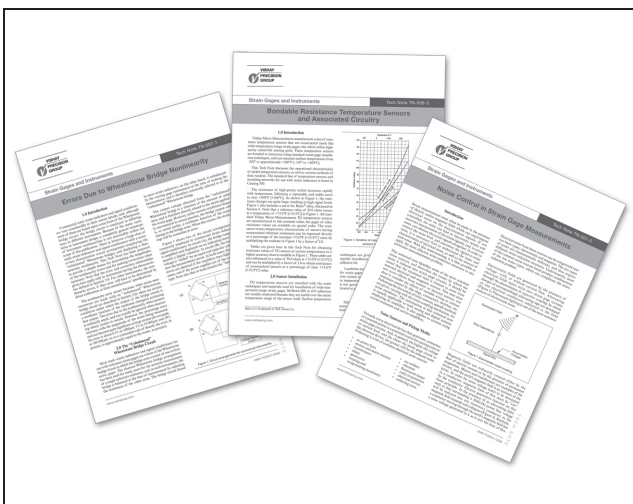

### TECHNICAL PUBLICATIONS

Micro-Measurements has published an extensive set of technical notes and detailed instructional literature on practical strain gage application techniques. Most of this technical literature is unique in that the content cannot be found in engineering textbooks or other published sources. This library of strain gage reference material is continuously updated to reflect the latest technology in application techniques.

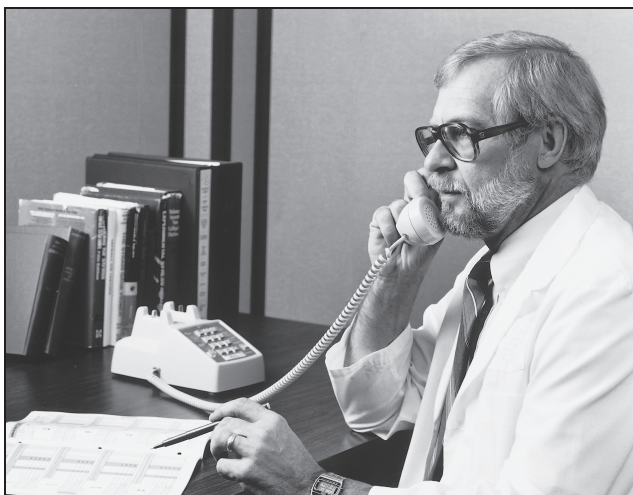

### APPLICATIONS ENGINEERING

In keeping with Micro-Measurements customer-service policies, help is never farther away than your telephone when you encounter a problem in strain gage application. A staff of trained Applications Engineers is always on duty at our facility in Raleigh, North Carolina during regular office hours, to answer your questions and provide whatever assistance you may need. They welcome your inquiries not only by telephone, facsimile and email, but also by personal visit to our facility.

## Technical Support



### TECHNICAL TRAINING

Micro-Measurements training programs cover all levels of strain gage technology. Our specially designed Technical Training Center in Raleigh, North Carolina is complete with the latest in visual-aid equipment, and features custom-built, fully equipped work stations for hands-on learning. Our strain gage workshops are hands-on programs where each participant completes gage installations using materials selected for suitability in a majority of gage operating environments. For a detailed description of these workshops, other courses, and schedule of dates, see our Training Program Brochure.









[www.vishaypg.com](http://www.vishaypg.com)



Data Book

## Strain Gage Accessories

### Micro-Measurements

[www.micro-measurements.com](http://www.micro-measurements.com)