

SPECIFICATION

MODEL : SPMWHT520A

Approved rank :

V_F(C0), CIE(A, B, K, C, D, E, F, G, H, J, P, R, T, U, V, W), I_v(S0)

WHITE LED

SAMSUNG LED CO., LTD.

314. MAETAN 3-DONG, YEONGTONG-GU,
SUWON-SI, GYEONGGI-DO, KOREA, 443-743

Contents

1. Product Outline	-----	3
2. Absolute Maximum Rating	-----	3
3. Characteristics	-----	3
4. Chromaticity Diagram	-----	7
5. Typical Characteristic Graph	-----	8
6. Outline Drawing & Dimension	-----	9
7. Reliability Test Items & Conditions	-----	10
8. Solder Conditions	-----	11
9. Taping Dimension	-----	12
10. Label Structure	-----	13
11. Lot Number	-----	13
12. Reel Packing Structure	-----	14
13. Aluminum Packing Bag	-----	15
14. Precaution For Use	-----	16
15. Hazard Substance Analysis	-----	18
16. Revision history	-----	22

1. Product Outline

1) Feature

- . Lead Frame Type LED Package (5.2 * 6.0 * t 1.3 mm)
- . Beam Angle ($\Delta\theta$: 120°)
- . AlGaInP, GaN/Al₂O₃ Chip & Long Time Reliability

2) Applications

- . Indoor, Outdoor Display and etc.

2. Absolute Maximum Rating

- 1). Operation Forward Current Per Chip..... 60 mA
- 2). Peak Pulsed Forward Current Per Chip..... 200 mA
(Duty 1/10 Pulse Width 10 ms)
- 3). Reverse Current..... 85 mA
- 4). Operating Temperature Range (T_{opr}) -30 °C ~ 85 °C
- 5). Storage Temperature Range (T_{stg}) -40 °C ~ 100 °C

3. Characteristics

Electrical/ Optical Characteristics

(Ta : 25 °C)

Item	Symbol	Conditions	Rank	Min.	Typ.	Max.	Unit
Forward Voltage (*)	V _F	I _F = 100 mA	C0	3.0	-	3.5	V
Reverse Voltage	V _r	I _R = 10 mA	-	0.6	-	2.0	V
Color Rendering	R _a	I _F = 100 mA	2	-	-	70	-
			5	78	85	-	-

* Tolerance : V_F:±0.1 V, I_V:±5 %, x,y:±0.01, R_a :±3.0

* Luminous Intensity measuring equipment : CAS140CT

Luminous Intensity

(Ta : 25 °C)

Item	Symbol	Conditions	Rank	Model Name	Vf Sorting	Min.	Typ.	Max.	Unit
Luminous Intensity (*)	I _v	I _F = 100 mA	A0	SPMWHT520AN2CAA0S0	0.1 V	7.0	8.0	11.0	cd
			B0	SPMWHT520AN2CAB0S0	0.1 V	7.3	8.5	11.4	
			K0	SPMWHT520AN2C0K0S0	전체	7.3	8.5	11.5	
			C0	SPMWHT520AN2CAC0S0	0.1 V	7.4	8.4	11.4	
				SPMWHT520AN2C0C0S0	전체				
			D0	SPMWHT520AN2CAD0S0	0.1 V	7.2	8.2	10.8	
				SPMWHT520AN2C0D0S0	전체				
			E0	SPMWHT520AN2CAE0S0	0.1 V	7.0	8.0	10.6	
				SPMWHT520AN2C0E0S0	전체				
			F0	SPMWHT520AN2CAF0S0	0.1 V	6.5	7.5	10.2	
				SPMWHT520AN2C0F0S0	전체				
			G0	SPMWHT520AN2CAG0S0	0.1 V	6.0	7.5	9.5	
			H0	SPMWHT520AN2CAH0S0	0.1 V	6.0	7.5	9.5	
			J0	SPMWHT520AN2CAJ0S0	0.1 V	6.0	7.5	9.5	
			P0	SPMWHT520AN5CAP0S0	0.1 V	6.7	7.6	10.0	
				SPMWHT520AN5C0P0S0	전체				
			R0	SPMWHT520AN5CAR0S0	0.1 V	6.8	7.8	10.0	
				SPMWHT520AN5C0R0S0	전체				
			T0	SPMWHT520AN5CAT0S0	0.1 V	6.5	7.6	10.0	
				SPMWHT520AN5C0T0S0	전체				
U0	SPMWHT520AN5CAU0S0	0.1 V	6.3	7.2	9.5				
	SPMWHT520AN5C0U0S0	전체							
V0	SPMWHT520AN5CAV0S0	0.1 V	6.0	7.0	9.2				
	SPMWHT520AN5C0V0S0	전체							
W0	SPMWHT520AN5CAW0S0	0.1 V	6.0	7.0	9.2				
	SPMWHT520AN5C0W0S0	전체							

Chromaticity Coordinate

(Ta : 25 °C)

Item	Condition	Rank	x				y				
Chromaticity Coordinate (*)	If = 100 mA	A0	A1	0.2771	0.2869	0.2833	0.2725	0.2507	0.2698	0.2763	0.2564
			A2	0.2869	0.2976	0.2951	0.2833	0.2698	0.2906	0.2981	0.2763
			A3	0.2725	0.2833	0.2799	0.2684	0.2564	0.2763	0.2826	0.2615
			A4	0.2833	0.2951	0.2926	0.2799	0.2763	0.2981	0.3057	0.2826
		B0	B1	0.2976	0.3081	0.3064	0.2951	0.2906	0.3110	0.3191	0.2981
			B2	0.3081	0.3190	0.3177	0.3064	0.3110	0.3322	0.3402	0.3191
			B3	0.2951	0.3064	0.3046	0.2926	0.2981	0.3191	0.3277	0.3057
			B4	0.3064	0.3177	0.3162	0.3046	0.3191	0.3402	0.3489	0.3277
		K0	K1	0.2940	0.3000	0.3060	0.3020	0.3100	0.3200	0.3020	0.2970
			K2	0.3000	0.3050	0.3110	0.3060	0.3200	0.3300	0.3080	0.3020
			K3	0.3050	0.3110	0.3150	0.3110	0.3300	0.3400	0.3150	0.3080
			K4	0.3110	0.3165	0.3200	0.3150	0.3400	0.3480	0.3255	0.3150
			K5	0.3165	0.3220	0.3280	0.3200	0.3480	0.3580	0.3450	0.3255
		C0	C1	0.3287	0.3375	0.3232	0.3145	0.3118	0.3271	0.3312	0.3161
			C2	0.3375	0.3462	0.3323	0.3232	0.3271	0.3422	0.3470	0.3312
			C3	0.3462	0.3560	0.3418	0.3323	0.3422	0.3593	0.3637	0.3470
			C4	0.3560	0.3667	0.3526	0.3418	0.3593	0.3777	0.3825	0.3637
		D0	D1	0.3639	0.3729	0.3572	0.3481	0.3407	0.3557	0.3607	0.3455
			D2	0.3729	0.3824	0.3668	0.3572	0.3557	0.3714	0.3766	0.3607
			D3	0.3824	0.3923	0.3770	0.3668	0.3714	0.3880	0.3934	0.3766
			D4	0.3923	0.4028	0.3877	0.3770	0.3880	0.4055	0.4111	0.3934
		E0	E1	0.4070	0.3884	0.3786	0.3584	0.3732	0.3796	0.3651	0.4070
			E2	0.4174	0.3990	0.3884	0.3732	0.3885	0.3953	0.3796	0.4174
			E3	0.4285	0.4101	0.3990	0.3885	0.4048	0.4117	0.3953	0.4285
			E4	0.4403	0.4225	0.4101	0.4048	0.4223	0.4300	0.4117	0.4403
		F0	F1	0.4493	0.4250	0.4108	0.3703	0.3856	0.3943	0.3788	0.4493
			F2	0.4640	0.4402	0.4250	0.3856	0.4016	0.4108	0.3943	0.4640
			F3	0.4792	0.4557	0.4402	0.4016	0.4182	0.4277	0.4108	0.4792
			F4	0.4957	0.4726	0.4557	0.4182	0.4361	0.4461	0.4277	0.4957
		G0	G1	0.4649	0.4789	0.4546	0.4404	0.3576	0.3728	0.3816	0.3661
			G2	0.4789	0.4936	0.4698	0.4546	0.3728	0.3889	0.3981	0.3816
			G3	0.4936	0.5088	0.4853	0.4698	0.3889	0.4055	0.4150	0.3981
			G4	0.5088	0.5253	0.5022	0.4853	0.4055	0.4234	0.4334	0.4150
		H0	H1	0.3541	0.3681	0.3438	0.3296	0.2674	0.2826	0.2914	0.2759
			H2	0.3681	0.3828	0.3590	0.3438	0.2826	0.2987	0.3079	0.2914
			H3	0.3828	0.3980	0.3745	0.3590	0.2987	0.3153	0.3248	0.3079
			H4	0.3980	0.4145	0.3914	0.3745	0.3153	0.3332	0.3432	0.3248
		J0	J1	0.3465	0.3605	0.3362	0.3220	0.2316	0.2468	0.2556	0.2401
			J2	0.3605	0.3752	0.3514	0.3362	0.2468	0.2629	0.2721	0.2556
			J3	0.3752	0.3904	0.3669	0.3514	0.2629	0.2795	0.2890	0.2721
J4	0.3904		0.4069	0.3838	0.3669	0.2795	0.2974	0.3074	0.2890		

Chromaticity Coordinate

(Ta : 25 °C)

Item	Condition	Rank	x				y				
Chromaticity Coordinate (*)	If = 100 mA	P0	P1	0.3096	0.3164	0.3145	0.3068	0.2979	0.3046	0.3187	0.3113
			P2	0.3164	0.3232	0.3221	0.3145	0.3046	0.3114	0.3261	0.3187
			P3	0.3232	0.3292	0.3289	0.3222	0.3114	0.3175	0.3302	0.3243
			P4	0.3292	0.3361	0.3366	0.3289	0.3175	0.3244	0.3369	0.3302
			P5	0.3068	0.3145	0.3131	0.3048	0.3113	0.3187	0.3290	0.3209
			P6	0.3145	0.3221	0.3213	0.3131	0.3187	0.3261	0.3371	0.3290
			P7	0.3222	0.3289	0.3287	0.3214	0.3243	0.3302	0.3417	0.3354
			P8	0.3289	0.3366	0.3371	0.3287	0.3302	0.3369	0.3490	0.3417
			P9	0.3048	0.3131	0.3117	0.3028	0.3209	0.3290	0.3393	0.3304
			PA	0.3131	0.3213	0.3205	0.3117	0.3290	0.3371	0.3481	0.3393
			PB	0.3214	0.3287	0.3285	0.3207	0.3354	0.3417	0.3533	0.3462
			PC	0.3287	0.3371	0.3376	0.3285	0.3417	0.3490	0.3616	0.3533
			PD	0.3028	0.3117	0.3107	0.3012	0.3304	0.3393	0.3464	0.3380
			PE	0.3117	0.3205	0.3200	0.3107	0.3393	0.3481	0.3546	0.3464
			PF	0.3207	0.3285	0.3283	0.3200	0.3462	0.3533	0.3619	0.3546
			PG	0.3285	0.3376	0.3379	0.3283	0.3533	0.3616	0.3704	0.3619
		R0	R1	0.3292	0.3361	0.3366	0.3289	0.3175	0.3238	0.3369	0.3302
			R2	0.3361	0.3429	0.3440	0.3366	0.3238	0.3301	0.3428	0.3369
			R3	0.3429	0.3498	0.3515	0.3440	0.3301	0.3365	0.3487	0.3428
			R4	0.3498	0.3574	0.3590	0.3512	0.3365	0.3434	0.3521	0.3465
			R5	0.3289	0.3366	0.3371	0.3287	0.3302	0.3369	0.3490	0.3417
			R6	0.3366	0.3440	0.3451	0.3371	0.3369	0.3428	0.3554	0.3490
			R7	0.3440	0.3515	0.3533	0.3451	0.3428	0.3487	0.3620	0.3554
			R8	0.3512	0.3590	0.3615	0.3529	0.3465	0.3521	0.3659	0.3597
			R9	0.3287	0.3371	0.3376	0.3285	0.3417	0.3490	0.3616	0.3533
			RA	0.3371	0.3451	0.3463	0.3376	0.3490	0.3554	0.3687	0.3616
			RB	0.3451	0.3533	0.3551	0.3463	0.3554	0.3620	0.3760	0.3687
			RC	0.3529	0.3615	0.3641	0.3548	0.3597	0.3659	0.3804	0.3736
			RD	0.3285	0.3376	0.3379	0.3283	0.3533	0.3616	0.3694	0.3619
			RE	0.3376	0.3463	0.3470	0.3379	0.3616	0.3687	0.3765	0.3694
		RF	0.3463	0.3551	0.3561	0.3470	0.3687	0.3760	0.3835	0.3765	
		RG	0.3548	0.3641	0.3661	0.3561	0.3736	0.3804	0.3914	0.3835	
		T0	T1	0.3574	0.3647	0.3670	0.3590	0.3434	0.3475	0.3578	0.3521
			T2	0.3647	0.3753	0.3783	0.3670	0.3475	0.3536	0.3646	0.3578
			T3	0.3753	0.3859	0.3898	0.3783	0.3536	0.3597	0.3716	0.3646
			T4	0.3590	0.3670	0.3702	0.3615	0.3521	0.3578	0.3722	0.3659
			T5	0.3670	0.3783	0.3825	0.3702	0.3578	0.3646	0.3798	0.3722
			T6	0.3783	0.3898	0.3950	0.3825	0.3646	0.3716	0.3875	0.3798
			T7	0.3615	0.3702	0.3736	0.3641	0.3659	0.3722	0.3874	0.3804
			T8	0.3702	0.3825	0.3869	0.3736	0.3722	0.3798	0.3958	0.3874
T9	0.3825		0.3950	0.4006	0.3869	0.3798	0.3875	0.4044	0.3958		
TA	0.3641		0.3736	0.3758	0.3661	0.3804	0.3874	0.3971	0.3914		
TB	0.3736		0.3869	0.3896	0.3758	0.3874	0.3958	0.4055	0.3971		
TC	0.3869		0.4006	0.4038	0.3896	0.3958	0.4044	0.4140	0.4055		

Chromaticity Coordinate

(Ta : 25 °C)

Item	Condition	Rank	x				y				
Chromaticity Coordinate (*)	I _F = 100 mA	U0	U1	0.3859	0.3981	0.4017	0.3889	0.3597	0.3658	0.3751	0.3690
			U2	0.3981	0.4106	0.4147	0.4017	0.3658	0.3719	0.3814	0.3751
			U3	0.3889	0.4017	0.4080	0.3941	0.3690	0.3751	0.3916	0.3848
			U4	0.4017	0.4147	0.4221	0.4080	0.3751	0.3814	0.3984	0.3916
			U5	0.3941	0.4080	0.4146	0.3996	0.3848	0.3916	0.4089	0.4015
			U6	0.4080	0.4221	0.4299	0.4146	0.3916	0.3984	0.4165	0.4089
			U7	0.3996	0.4146	0.4196	0.4038	0.4015	0.4089	0.4220	0.4140
			U8	0.4146	0.4299	0.4358	0.4196	0.4089	0.4165	0.4301	0.4220
		V0	V1	0.4106	0.4207	0.4259	0.4147	0.3719	0.3744	0.3853	0.3814
			V2	0.4207	0.4309	0.4373	0.4259	0.3744	0.3769	0.3893	0.3853
			V3	0.4147	0.4259	0.4342	0.4221	0.3814	0.3853	0.4028	0.3984
			V4	0.4259	0.4373	0.4465	0.4342	0.3853	0.3893	0.4071	0.4028
			V5	0.4221	0.4342	0.4430	0.4299	0.3984	0.4028	0.4212	0.4165
			V6	0.4342	0.4465	0.4562	0.4430	0.4028	0.4071	0.4260	0.4212
			V7	0.4299	0.4430	0.4490	0.4358	0.4165	0.4212	0.4337	0.4301
			V8	0.4430	0.4562	0.4619	0.4490	0.4212	0.4260	0.4372	0.4337
		W0	W1	0.4309	0.4415	0.4483	0.4373	0.3769	0.3795	0.3919	0.3893
			W2	0.4415	0.4521	0.4593	0.4483	0.3795	0.3822	0.3944	0.3919
			W3	0.4373	0.4483	0.4582	0.4465	0.3893	0.3919	0.4099	0.4071
			W4	0.4483	0.4593	0.4700	0.4582	0.3919	0.3944	0.4126	0.4099
			W5	0.4465	0.4582	0.4687	0.4562	0.4071	0.4099	0.4289	0.4260
			W6	0.4582	0.4700	0.4813	0.4687	0.4099	0.4126	0.4319	0.4289
			W7	0.4562	0.4687	0.4752	0.4619	0.4260	0.4289	0.4407	0.4372
			W8	0.4687	0.4813	0.4886	0.4752	0.4289	0.4319	0.4443	0.4407

4. Chromaticity Diagram

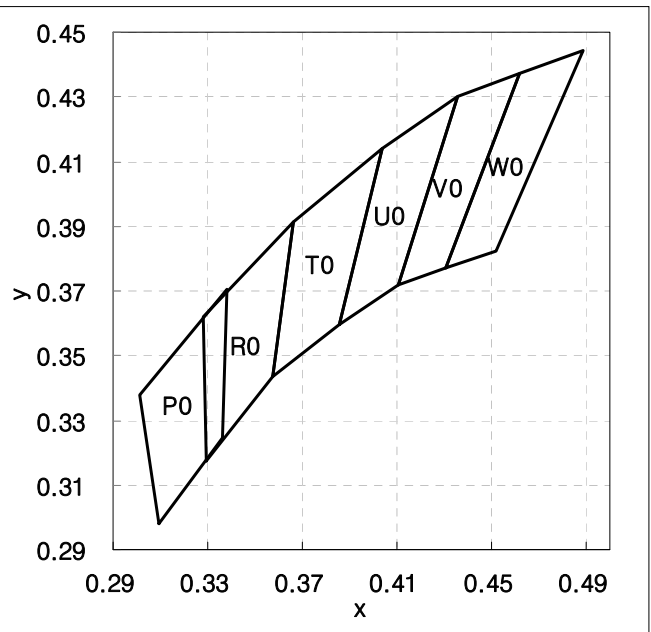
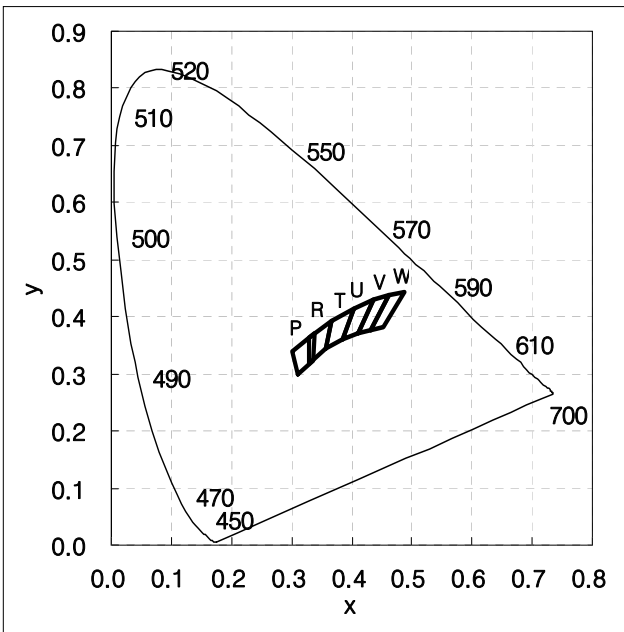
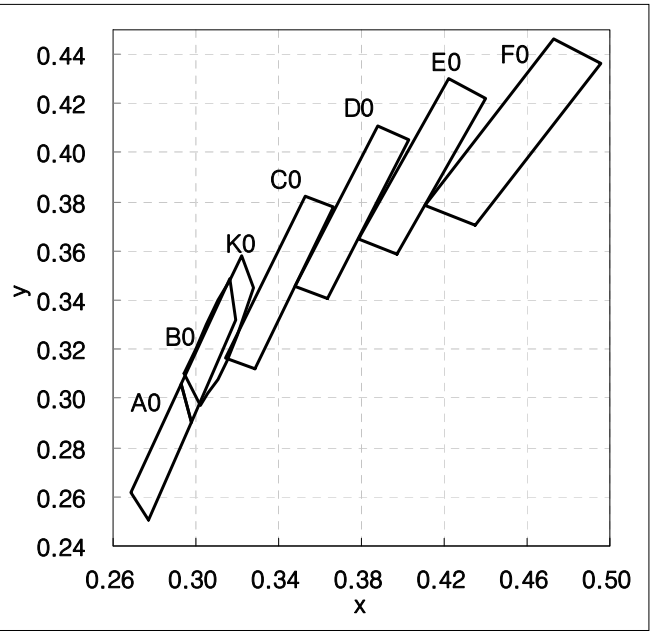
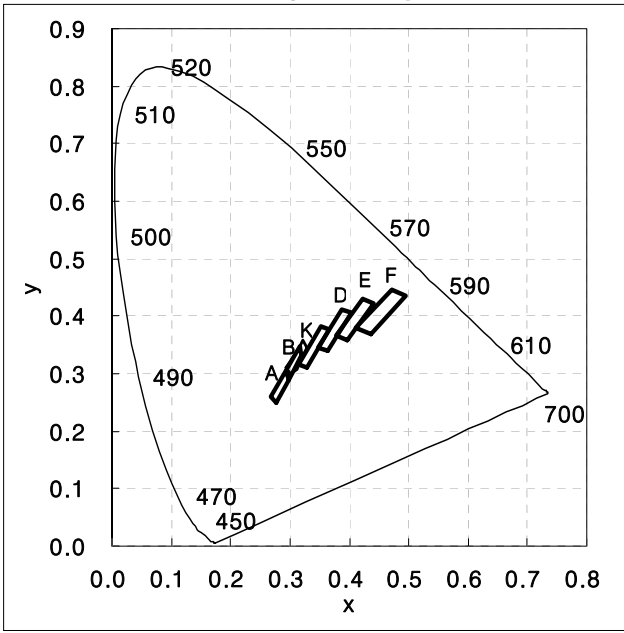

5. Typical Characteristics Graph

* These graphs show typical values.

(Ta : 25 °C)

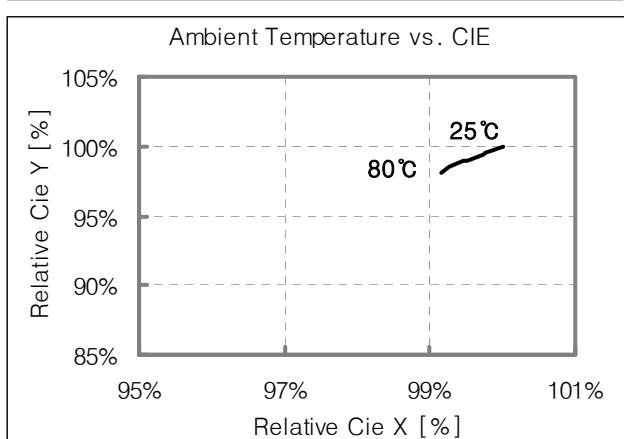
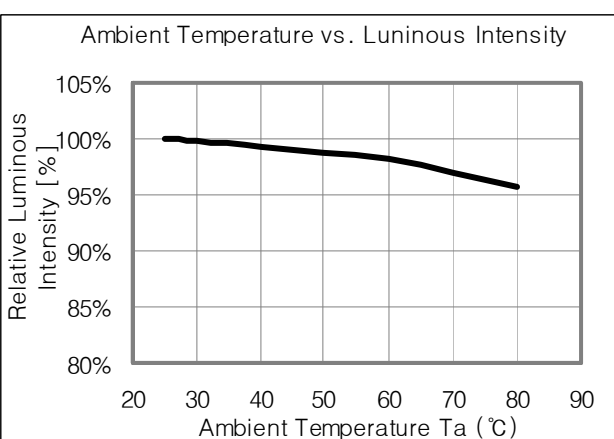
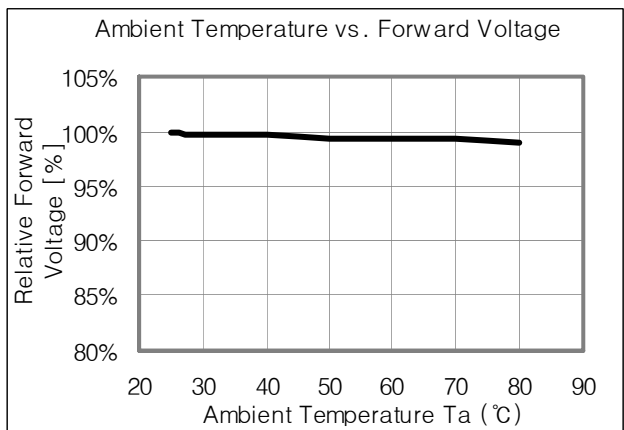
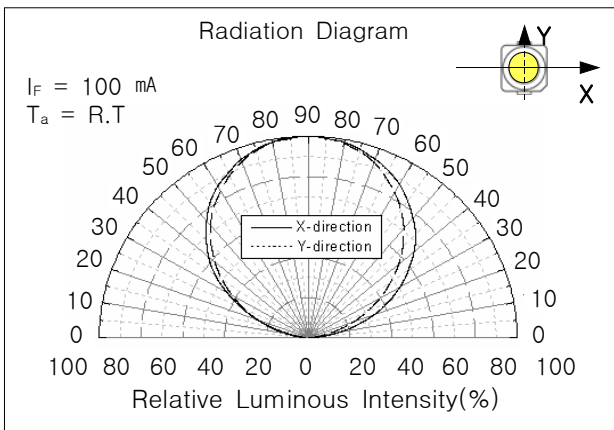
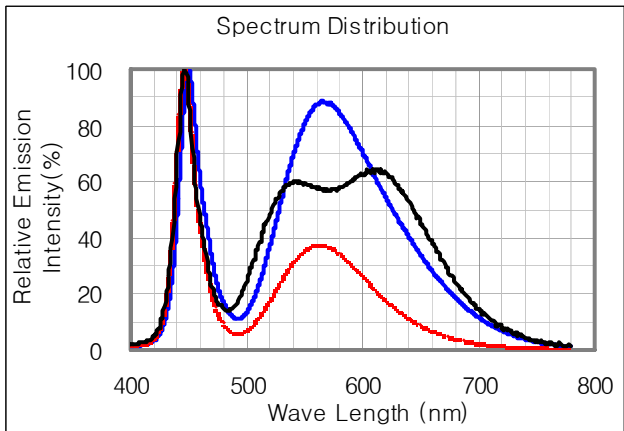
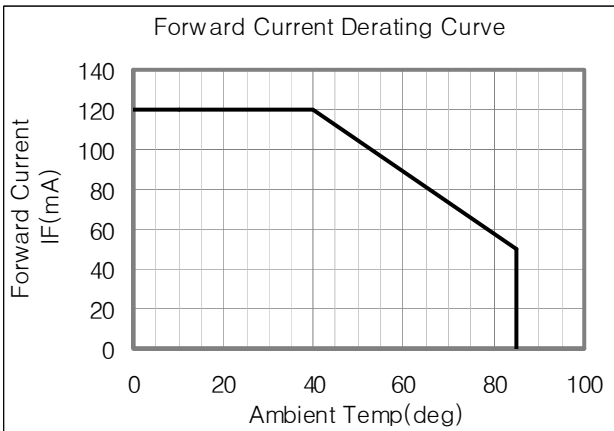
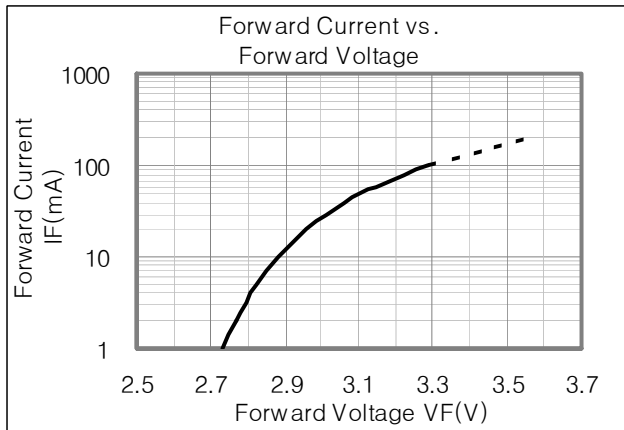
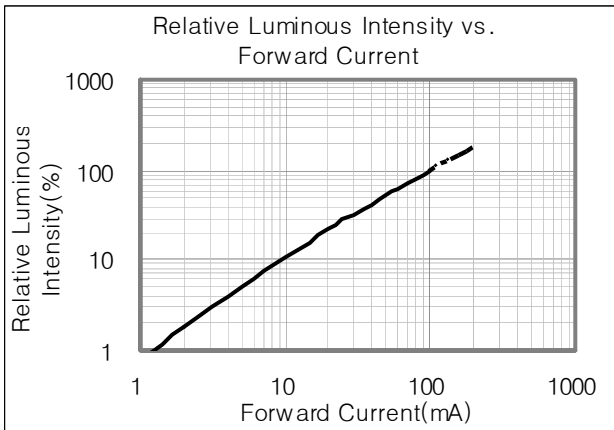

6. LED Package Outline Dimensions

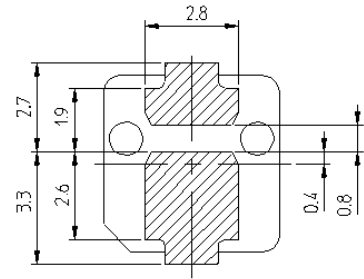
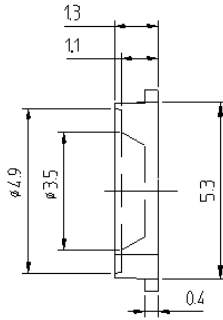
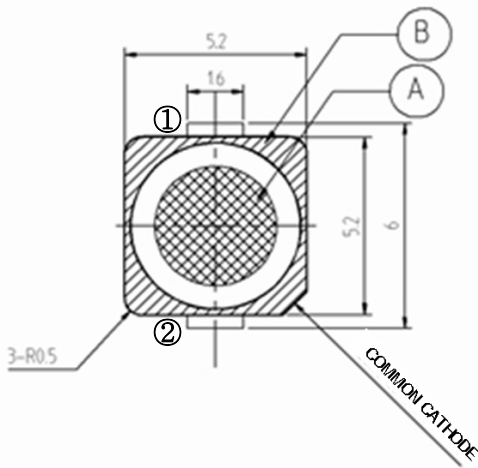

1. Tolerance is $\pm 0.1\text{mm}$.
2. Do not place pressure on the encapsulating resin ('A').
3. The maximum compressing force is 15N on the polymer ('B').

① Anode

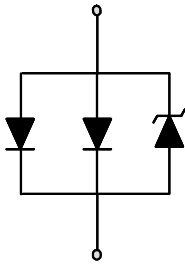

② Cathode Circuit Diagram

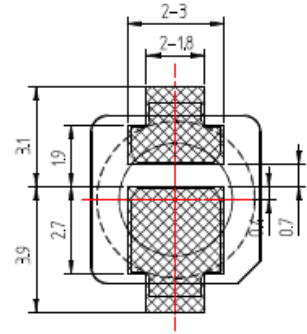
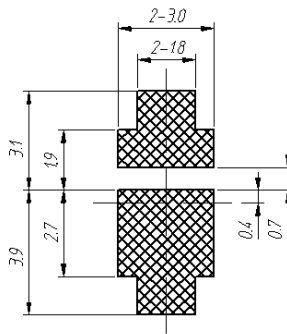

Land Pattern

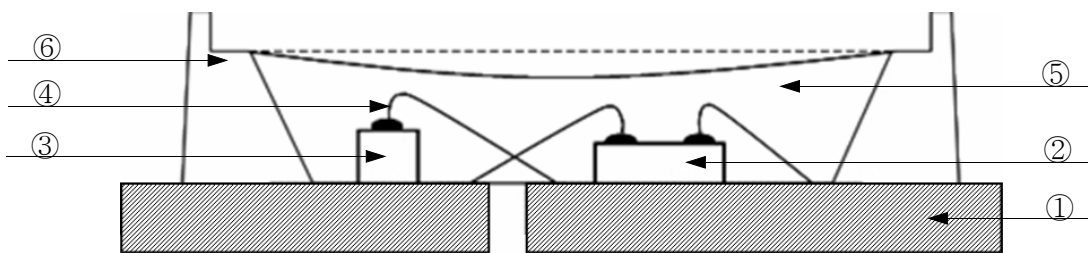

NUMBER	ITEM	MATERIAL
①	FRAME	Copper Frame(Silver Plated)
②	LED CHIP	GaN/Al ₂ O ₃
③	Zener Diode	Si
④	WIRE	Gold Wire
⑤	RESIN	Silicone + Phosphor
⑥	PACKAGE	Heat-resistant Polymer

7. Reliability Test Items and Conditions

1) Test Items

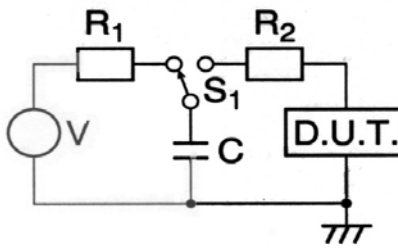
Test Item	Test Conditions	Test Hours/Cycles	Sample No
Room Temperature life test	25 °C ±3 °C, DC120 mA	500 hrs	50
High Temperature humidity life test	60 °C ±3 °C, 95 %±2 %RH, DC90 mA	500 hrs	50
High Temperature life test	85 °C ±3 °C, DC50 mA	500 hrs	50
Low Temperature life test	-30 °C ±3 °C, DC120 mA	500 hrs	50
High Temperature Storage	Ta=100 °C ±3 °C	500 hrs	22
Low Temperature Storage	Ta=-40 °C ±3 °C	500 hrs	22
High Temperature humidity Storage	60 °C ±3 °C, 95 %±2 %RH	500 hrs	22
Thermal Shock	-40 °C ~ 100 °C 0.5 hrs 0.5 hrs	100 cycles	50
Temperature humidity Cycle	25 °C ~ 65 °C ~ -10 °C 24 hrs/1 cycle, 95 %RH	10 cycles	22
Reflow (Pb-Free)	Peak 260±5 °C for 10 sec	3 times	22
ESD(HBM)	 <p>-R1:10 MΩ , R2:1.5 kΩ , C:100 pF</p>	5 times	5
On/Off test	50 °C ±3 °C, 95 %±2 %RH, DC120 mA, On/2 sec, Off/2 sec	108000 cycles	50

2) Criteria for Judging the Damage

Item	Symbol	Test Condition	Limit	
			Min	Max
Forward Voltage	V_F	$I_F = 100 \text{ mA}$	-	U.S.L.*1.2
Luminous Intensity	I_v	$I_F = 100 \text{ mA}$	L.S.L.*0.5	-

* USL : Upper Standard Level LSL : Lower Standard Level

8. Solder Conditions

1) Reflow Conditions (Pb Free)

Reflow Frequency : 2 times max.

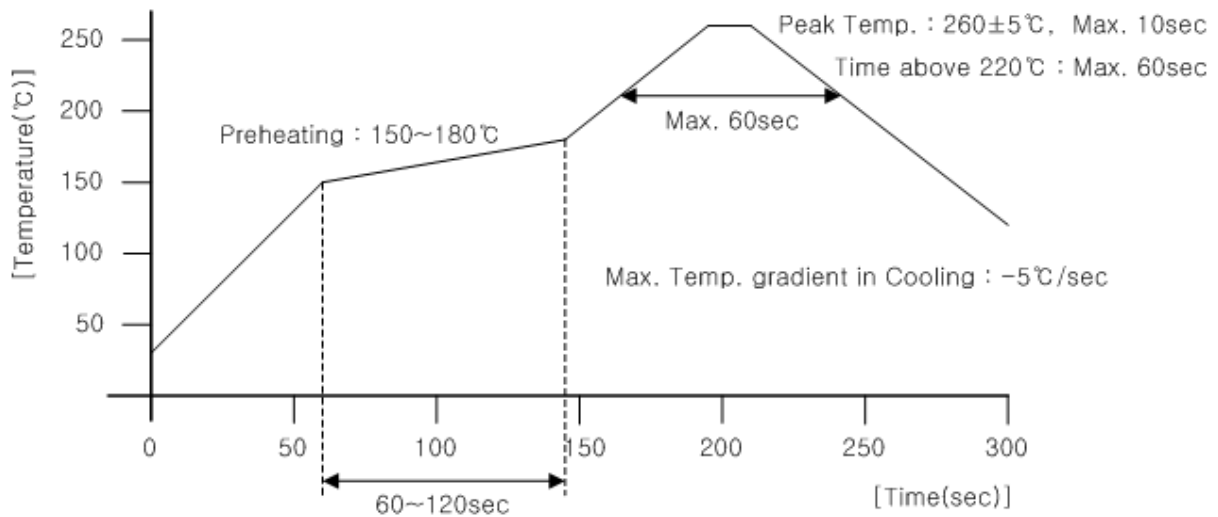

2) For Manual Soldering

Not more than 5 seconds @MAX300 °C, under soldering iron.

9. Taping Dimension

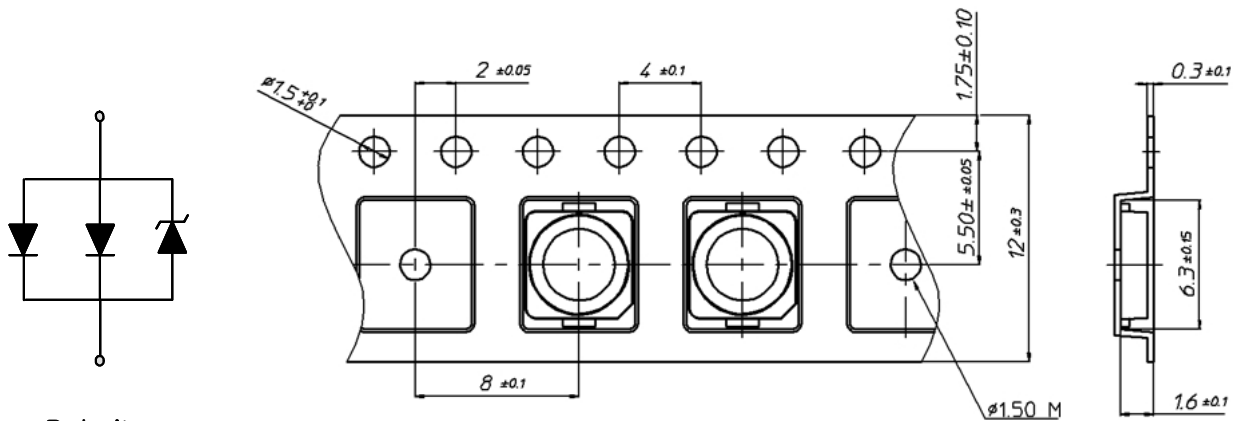

Polarity

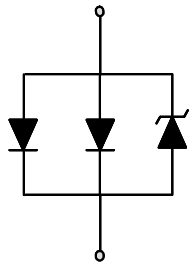

End

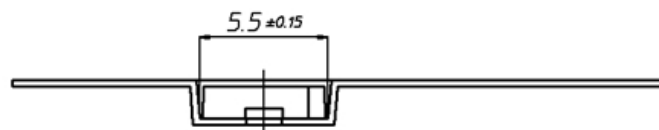

Start

More than 40 mm
Unloaded tape

Mounted with
Flash LED

More than (100~200)mm
Unloaded tape

Leading part more than
(200~400)mm

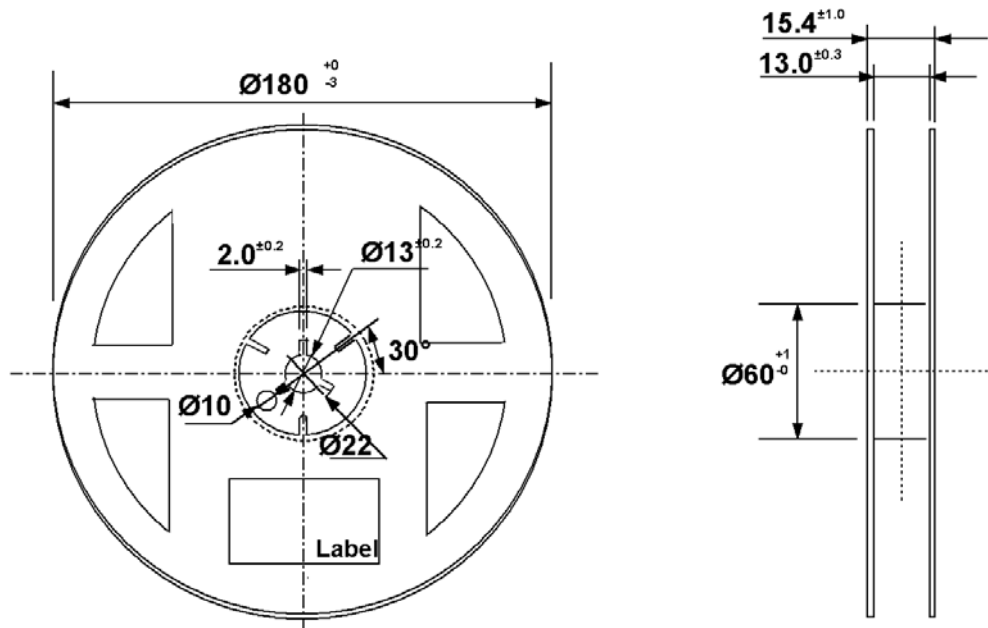

Tolerance ± 0.2 , Unit:mm

- (1) Quantity : The quantity/reel to be 1000 pcs.
- (2) Cumulative Tolerance : Cumulative tolerance/10 pitches to be ± 0.2 mm
- (3) Adhesion Strength of Cover Tape : Adhesion strength to be 0.1–0.7 N when the cover tape is turned off from the carrier tape at 10 °C angle to be the carrier tape.
- (4) Packaging : P/N, Manufacturing data code no. and quantity to be indicated on a damp proof package.

10. Label Structure

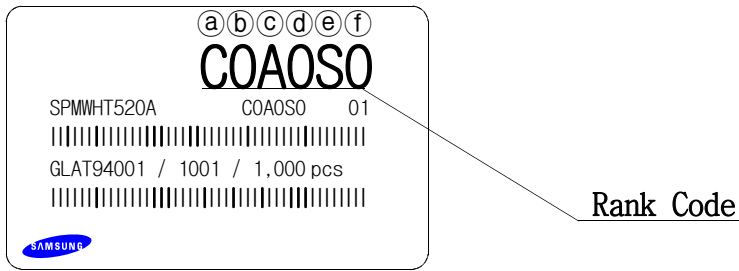

N.B) Denoted rank is the only example.

Rank Code

- (a)(b) : Forward Voltage(V_F) Rank (refer to page. 3)
- (c)(d) : Chromaticity Coordinate Rank (refer to page. 5~7)
- (e)(f) : Luminous Intensity(I_v) Rank (refer to page. 4)

11. Lot Number

The Lot number is composed of the following characters

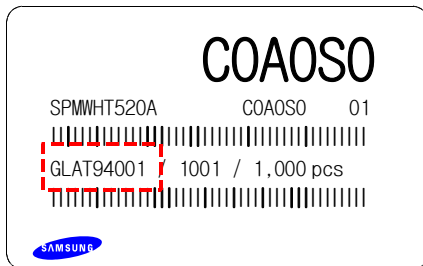

①②③④⑤⑥⑦⑧⑨ / 1(a)(b)(c) / 1,000 PCS

- ① : Production Site (S:SAMSUNG LED, G:GOSIN CHINA)
- ② : L (LED)
- ③ : Product State (A:Normality, B:Bulk, C:First Production, R:Reproduction, S:Sample)
- ④ : Year (T:2009, U:2010, V:2011...)
- ⑤ : Month (1 ~ 9, A, B)
- ⑥ : Day (1 ~ 9, A, B ~ V)
- ⑦⑧⑨ : SAMSUNG LED Product number (1 ~ 999)
- (a)(b)(c) : Reel Number (1 ~ 999)

12. Reel Packing Structure

Reel

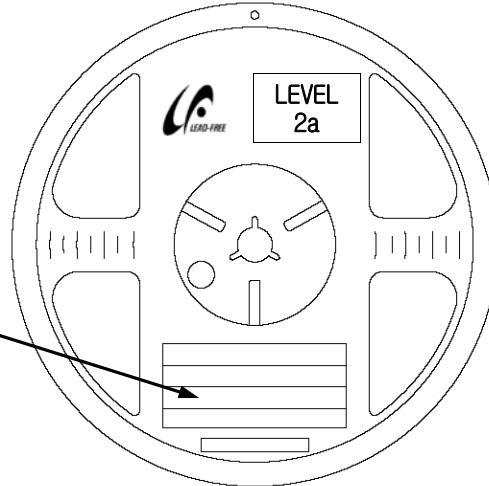
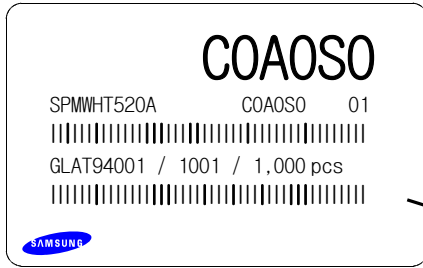

Aluminum Vinyl Bag

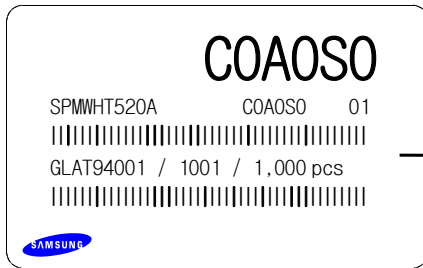

Material : Paper(SW3B(B))

TYPE	SIZE(mm)		
	L	W	H
7inch	245	220	182

① SIDE

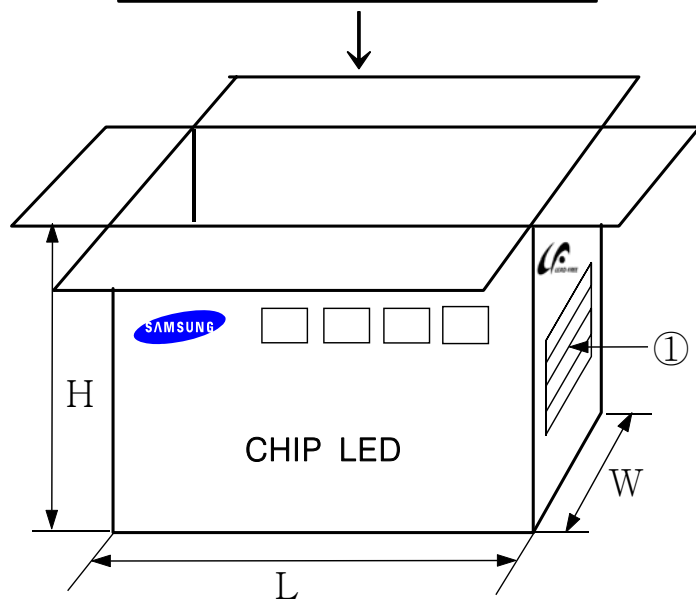
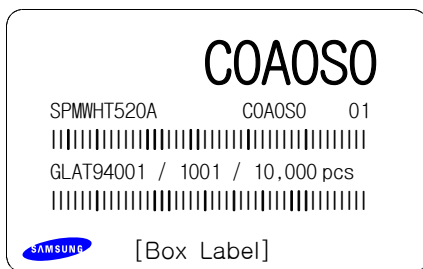

13. Aluminum Vinyl Bag



CAUTION

This bag contains
MOISTURE SENSITIVE DEVICES

LEVEL

2a

1. Shelf life in sealed bag: 12 months at <math> < 40^{\circ}\text{C}</math> and <math> < 90\%</math> relative humidity (RH)
2. Peak package body temperature: 240 °C
3. After this bag is opened, devices that will be subjected to reflow solder or other high temperature processes must be:
 - a. Mounted within 672 hours at factory conditions of equal to or less than 30°C / 60% RH, or
 - b. Stored at <math> < 10\%</math> RH
4. Devices require bake, before mounting, if:
 - a. Humidity Indicator Card is > 65% when read at 23±5°C, or
 - b. 2a is not met.
5. If baking is required, devices must be baked for 1 hours at 60±5°C

Note: if device containers cannot be subjected to high temperature or shorter bake times are desired, reference IPC/JEDEC J-STD-033 for bake procedure,

Bag seal due date: _____
(if blank, see code label)

Note: Level and body temperature by IPC/JEDEC J-STD-020

COAOSO

SPMWH520A COAOSO 01

|||||

GLAT94001 / 1001 / 1,000 pcs

|||||

SAMSUNG



주의 사항

이 알루미늄 지퍼 백은 습기 및 정전기로부터 제품을 보호하기 위하여 제작되었습니다. 개봉 후에는 즉시 솔더 작업을 실시하는 것을 권장합니다.

습기 및 정전기로부터 제품을 보호 하기 위해서 개봉 후 사용하지 않는 자재는 본 팩에 넣어 보관 하시기 바랍니다. 사용하지 않는 자재를 본 팩에 넣을 때는 반드시 동봉된 드라이 팩과 함께 넣고 지퍼부분을 완전하게 밀봉하여 주시기 바랍니다.

Important

This Al Zipper bag is designed to protect the enclosed products from moisture and ESD. Once opened, the products should be soldered onto the printed circuit board immediately. When not in use, please do not leave the products unprotected by the Al Zipper Bag. To repack unused products., please ensure the zip-lock is completely sealed with the dry pack left inside.

Silica gel & Humidity Indicator Card in Aluminum Vinyl Bag

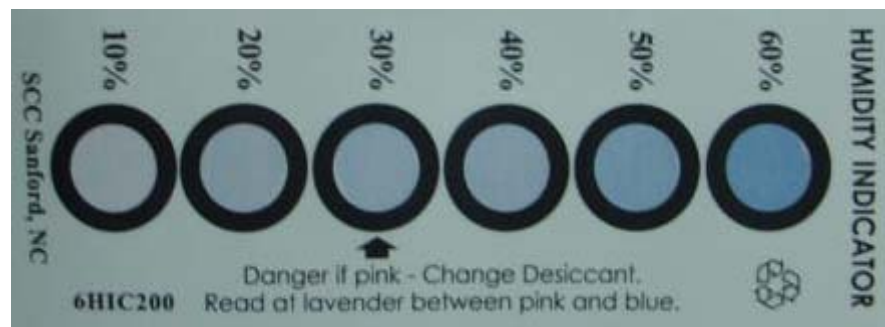

14. Precaution for Use (취급상 주의사항)

- 1) For over-current-proof function, customers are recommended to apply resistors to prevent sudden change of the current caused by slight shift of the voltage.
과전류 방지를 위해 전압의 미세한 이동에 의해 야기되는 전류의 순간 변화를 방지하기 위해 저항 등의 설치를 권장함.
- 2) This device should not be used in any type of fluid such as water, oil, organic solvent, etc. When washing is required, IPA is recommended to use.
제품은 물, 오일, 유기물과 같은 액체 타입에서의 사용은 제한되며, 세정이 필요할 시에는 IPA 사용을 권장함.
- 3) When the LEDs illuminate, operating current should be decided after considering the ambient maximum temperature.
LED의 발광 시, 동작 전류는 주변 최고온도를 고려하여 결정되어야 함.
- 4) LEDs must be stored in a clean environment.
If the LEDs are to be stored for 3 months or more after being shipped from SLED, they should be packed by a sealed container with nitrogen gas injected.
(Shelf life of sealed bags: 12 months, temp. 0~40 °C, 20~70 %RH)
LED의 보관은 청정한 환경에서 보존되어야 하며, 만약 삼성LED로부터 공급받는 후 3개월 또는 그 이상 보관이 필요하다면 질소 가스를 동봉한 보존용기에 보관되어야 함.
(보존 bag의 수명 : 12 개월, 보존 온도 0~40 °C, 습도 20~70 %RH)
- 5) After storage bag is open, device subjected to soldering, solder reflow, or other high temperature processes must be:
보존 Bag이 개봉된 후에, 납땀이나 reflow등의 높은 온도에 노출되는 제품은 다음의 사항에 부합되어야 함.
 - a. Mounted within 168 hours (7 days) at an assembly line with a condition of no more than 30 °C/60 %RH,
a. 제품은 30 °C/60 %RH보다 같거나 낮은 조립조건에서 168시간(7일)이내에 조립해야 함.
 - b. Stored at <10 %RH.
b. 10 % 이하의 상대습도에서 보관되어야 함.
- 6) Repack unused Products with anti-moisture packing, fold to close any opening and then store in a dry place.
사용하지 않은 제품은 방습팩에 넣어 개봉 부위를 닫아서 다시 포장한 후, 건조한 장소에서 보관할 것을 권장함.

7) Devices require baking before mounting, if humidity card reading is $>60\%$ at $23\pm 5\text{ }^{\circ}\text{C}$.

만약 습도표시카드의 수치가 $23\pm 5\text{ }^{\circ}\text{C}$ 에서 60% 이상이라면, 제품 실장 전에 baking하여야 함.

8) Devices must be baked for 24 hours at $65\pm 5\text{ }^{\circ}\text{C}$, if baking is required.

만약 baking이 필요하다면, 제품은 $65\pm 5\text{ }^{\circ}\text{C}$ 에서 24시간 정도 baking 되어야 함.

9) The LEDs are sensitive to the static electricity and surge. It is recommended to use a wrist band or anti-electrostatic glove when handling the LEDs.

LED는 정전기 및 서지에 민감한 제품이므로, LED 제품을 다룰 시에는 정전기 방지장갑이나 손목밴드를 사용하기를 권장함.

If voltage exceeding the absolute maximum rating is applied to LEDs, it may cause damage or even destruction to LED devices.

만약 절대 허용치를 초과하는 전압이 LED에 가해지면, LED 소자는 파괴되거나 손상될 수 있음.

Damaged LEDs may show some unusual characteristics such as increase in leak current, lowered turn-on voltage, or abnormal lighting of LEDs at low current.

손상된 제품은 누설전류의 증가, Turn on 전압의 저하, 저 전류에서의 점등불량 등의 이상 거동을 보일 수 있음.

15. Hazard Substance Analysis



Test Report No. F690501/LF-CTSAYAA08-24988

Issued Date: September 08, 2008 Page 1 of 4

To: **SAMSUNG ELECTRO-MECHANICS CO., LTD.**
 314, Maetan3-dong
 Yeongtong-gu
 Suwon-city
 KYUNGGI-DO 442-373
 Korea

The following merchandise was submitted and identified by the client as :

Product Name : 5252 high CRI LED
SGS File No. : AYAA08-24988
Received Date : September 01, 2008
Test Performing Date : September 02, 2008
Test Performed : SGS Testing Korea tested the sample(s) selected by applicant with following results
Test Results : For further details, please refer to following page(s)
Comments : By the applicant's specific request, the sampling and testing was performed only for the part indicated in the photo without disassembly.

Pluto Kim
 Monet Jeong
 Billy Oh / Testing Person

SGS Testing Korea Co. Ltd.

Jeff Jang / Chemical Lab Mgr

This document is issued by the Company under its General Conditions of Service printed contract or available on request and accessible at <http://www.sgs.com/conditions>. Attention is drawn to the limitation of liability, indemnification and jurisdiction clauses defined therein. Any holder of this document is advised that information contained herein reflects the Company's findings at the time of its intervention only and within the limits of Client's instructions, if any. The Company's sole responsibility is to its Client and this document does not constitute parties to a transaction. Any unauthorized alteration, forgery or falsification of the content or appearance of this document is unlawful and offenders may be prosecuted to the fullest extent of the law. Unless otherwise stated the results shown in this report refer only to the sample(s) tested. This document cannot be reproduced except in full, without prior approval of the Company.



Test Report No. F690501/LF-CTSAYAA08-24988

Issued Date: September 08, 2008 **Page** 2 of 4

Sample No. : AYAA08-24988.001
Sample Description : 5252 high CRI LED
Item No./Part No. : N/A

Heavy Metals

Test Items	Unit	Test Method	MDL	Results
Cadmium (Cd)	mg/kg	US EPA 3052(1996), US EPA 6010B(1996), ICP	0.5	N.D.
Lead (Pb)	mg/kg	US EPA 3052(1996), US EPA 6010B(1996), ICP	5	N.D.
Mercury (Hg)	mg/kg	US EPA 3052(1996), US EPA 6010B(1996), ICP	2	N.D.
Hexavalent Chromium (Cr VI)	mg/kg	US EPA 3060A(1996), US EPA 7196A(1992), UV	1	N.D.

Flame Retardants-PBBs/PBDEs

Test Items	Unit	Test Method	MDL	Results
Monobromobiphenyl	mg/kg	US EPA 3540C, GC/MS	5	N.D.
Dibromobiphenyl	mg/kg	US EPA 3540C, GC/MS	5	N.D.
Tribromobiphenyl	mg/kg	US EPA 3540C, GC/MS	5	N.D.
Tetrabromobiphenyl	mg/kg	US EPA 3540C, GC/MS	5	N.D.
Pentabromobiphenyl	mg/kg	US EPA 3540C, GC/MS	5	N.D.
Hexabromobiphenyl	mg/kg	US EPA 3540C, GC/MS	5	N.D.
Heptabromobiphenyl	mg/kg	US EPA 3540C, GC/MS	5	N.D.
Octabromobiphenyl	mg/kg	US EPA 3540C, GC/MS	5	N.D.
Nonabromobiphenyl	mg/kg	US EPA 3540C, GC/MS	5	N.D.
Decabromobiphenyl	mg/kg	US EPA 3540C, GC/MS	5	N.D.
Monobromodiphenyl ether	mg/kg	US EPA 3540C, GC/MS	5	N.D.
Dibromodiphenyl ether	mg/kg	US EPA 3540C, GC/MS	5	N.D.
Tribromodiphenyl ether	mg/kg	US EPA 3540C, GC/MS	5	N.D.
Tetrabromodiphenyl ether	mg/kg	US EPA 3540C, GC/MS	5	N.D.
Pentabromodiphenyl ether	mg/kg	US EPA 3540C, GC/MS	5	N.D.
Hexabromodiphenyl ether	mg/kg	US EPA 3540C, GC/MS	5	N.D.
Heptabromodiphenyl ether	mg/kg	US EPA 3540C, GC/MS	5	N.D.
Octabromodiphenyl ether	mg/kg	US EPA 3540C, GC/MS	5	N.D.
Nonabromodiphenyl ether	mg/kg	US EPA 3540C, GC/MS	5	N.D.
Decabromodiphenyl ether	mg/kg	US EPA 3540C, GC/MS	5	N.D.

- NOTE: (1) N.D. = Not detected.(<MDL)
 (2) mg/kg = ppm
 (3) MDL = Method Detection Limit
 (4) - = No regulation
 (5) ** = Qualitative analysis (No Unit)
 (6) Negative = Undetectable / Positive = Detectable

This document is issued by the Company under its General Conditions of Service printed overleaf or available on request and accessible at http://www.sgs.com/sgsweb/sgsweb.nsf/cont/sgsweb_.... Attention is drawn to the limitation of liability, indemnification and jurisdiction issues defined therein. Any holder of this document is advised that information contained herein reflects the Company's findings at the time of its intervention only and within the limits of Client's instructions, if any. The Company's sole responsibility is to its Client and this document does not constitute advice to a third party from exercising all their rights and obligations under the transaction documents. Any unauthorized alteration, forgery or falsification of the content or appearance of this document is unlawful and offenders may be prosecuted to the fullest extent of the law. Unless otherwise stated the results shown in this test report refer only to the sample(s) tested. This document cannot be reproduced except in full, without prior approval of the Company.

F052 Version2

SGS Testing Korea Co., Ltd.

322, The C valley, 555-8, Hagee-dong, Dongan-gu, Anyang-si, Gyeonggi-do, Korea 431-080
 T +82 (0)31 4806 000 F +82 (0)31 4808 059 <http://www.sgs.kor.kr> www.kr.sgs.com/greenlab

Member of the SGS Group (Société Générale de Surveillance)



Test Report No. F690501/LF-CTSAYAA08-24988

Issued Date: September 08, 2008 Page 3 of 4

Sample No. : AYAA08-24988.001
 Sample Description : 5252 high CRI LED
 Item No./Part No. : N/A

Halogen Contents

Test Items	Unit	Test Method	MDL	Results
Bromine(Br)	mg/kg	EN 14582:2007 , IC	30	N.D.
Chlorine(Cl)	mg/kg	EN 14582:2007 , IC	30	N.D.
Fluorine(F)	mg/kg	EN 14582:2007 , IC	30	N.D.
Iodine(I)	mg/kg	EN 14582:2007 , IC	30	N.D.

Other(s)

Test Items	Unit	Test Method	MDL	Results
PFOS(Perfluorooctane Sulfonates-Acid/Metal Salt/Amide)	mg/kg	US EPA 3540C, LC/MS	1	N.D.

- NOTE:
- (1) N.D. = Not detected.(<MDL)
 - (2) mg/kg = ppm
 - (3) MDL = Method Detection Limit
 - (4) - = No regulation
 - (5) ** = Qualitative analysis (No Unit)
 - (6) Negative = Undetectable / Positive = Detectable

This document is issued by the Company under its General Conditions of Service printed hereafter or available at www.sgs.com. Attention is drawn to the limitation of liability, indemnification and jurisdiction issues defined therein. Any holder of this document is advised that information contained herein reflects the Company's findings at the time of its intervention only and within the limits of Client's instructions, if any. The Company's sole responsibility is to its Client and this document does not constitute parties to a transaction from exercising all their rights and obligations under the transaction documents. Any unauthorized alteration, forgery or falsification of the content or appearance of this document is unlawful and offences may be prosecuted to the fullest extent of the law. Unless otherwise stated the results shown in this test report refer only to the sample(s) tested. This document cannot be reproduced except in full, without prior approval of the Company.

F052 Version2

SGS Testing Korea Co., Ltd.

322, The Ovalley, 555-B, Hogeje-dong, Dongan-gu, Anyang-si, Gyeonggi-do, Korea 431-092
 t +82 (0)31 4806 000 f +82 (0)31 4835 059 <http://www.sgs/ab.co.kr> www.kr.sgs.com/greenlab

Member of the SGS Group (Société Générale de Surveillance)



Test Report No. F690501/LF-CTSAYAA08-24988

Issued Date: September 08, 2008 Page 4 of 4

Picture of Sample as Received:

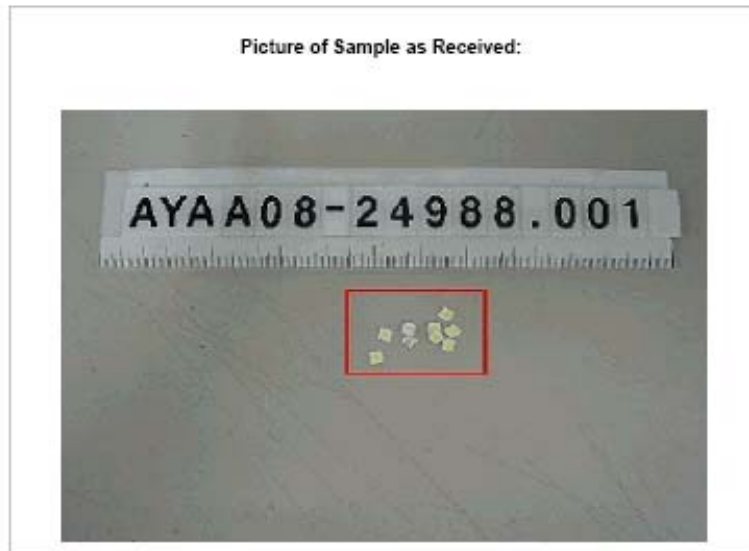

*** End ***

- NOTE:
- (1) N.D. = Not detected.(<MDL)
 - (2) mg/kg = ppm
 - (3) MDL = Method Detection Limit
 - (4) - = No regulation
 - (5) ** = Qualitative analysis (No Unit)
 - (6) Negative = Undetectable / Positive = Detectable

This document is issued by the Company under its General Conditions of Service printed, stored or available on request and accessible at <http://www.sgs.com/sgsweb>. Attention is drawn to the limitation of liability, indemnification and jurisdiction issues defined therein. Any holder of this document is advised that information contained herein reflects the Company's findings at the time of its intervention only and within the limits of Client's instructions, if any. The Company's sole responsibility is to its Client and this document does not exonerate parties to a transaction from exercising all their rights and obligations under the transaction documents. Any unauthorized alteration, forgery or falsification of the content or appearance of this document is unlawful and offenders may be prosecuted to the fullest extent of the law. Unless otherwise stated the results shown in this report refer only to the sample(s) tested. This document cannot be reproduced except in full, without prior approval of the Company.

F052 Version2

SGS Testing Korea Co., Ltd.

322, The O valley, 555-8, Hogeje-dong, Dongen-gu, Anyang-si, Gyeonggi-do, Korea 431-082
 t +82 (0)31 4808 000 f +82 (0)31 4805 059 <http://www.sgs/led> www.kr.sgs.com/sgstestlab

Member of the SGS Group (Société Générale de Surveillance)

