

DATE OF ISSUE : 2009. 07. 06

SPECIFICATION

MODEL : SPMRED3215A0AEFCSC

Approved rank : $V_F(E1,E2,E3,E4)$, $\lambda_D(C1,C2)$, $I_V(AB,BA,BB,CA)$

RED LED

SAMSUNG LED CO., LTD.
314. MAETAN 3-DONG, YEONGTONG-GU,
SUWON-SI,GYEONGGI-DO,KOREA,443-743

Contents

1.	Product Outline -----	3
2.	Absolute Maximum Rating -----	3
3.	Characteristics -----	3
4.	Typical Characteristic Graph -----	5
5.	Outline Drawing & Dimension -----	6
6.	Reliability Test Items & Conditions -----	7
7.	Solder Conditions -----	8
8.	Taping Dimension -----	9
9.	Label Structure -----	10
10.	Lot Number -----	10
11.	Reel Packing Structure -----	11
12.	Aluminium Packing Bag -----	12
13.	Precaution For Use -----	13
14.	Hazard Substance Analysis -----	14
15.	Revision History -----	17

1. Product Outline

1) Feature

- . Lead Frame Type LED Package (3.5 * 2.8 * t 1.9 mm)
- . Beam Angle ($\Delta\theta$: 120°)
- . AlGaInP/AIn Chip & Long Time Reliability

2) Applications

- . Automotive, Indoor, Outdoor Display and etc.

2. Absolute Maximum Rating

- 1). Operation Forward Current Per Chip 70 mA
 - 2). Peak Pulsed Forward Current Per Chip 100 mA
(Duty 33/1000 Pulse Width 3.03 msec)
 - 3). Reverse Voltage 5 V
 - 4). Operating Temperature Range (T_{opr}) -40°C ~ 100°C
 - 5). Storage Temperature Range (T_{stg}) -40°C ~ 100°C
- . I_{FP} Conditions : Duty 33/1000 Pulse Width 3.03 ms

3. Characteristics

Electrical/ Optical Characteristics

(T_a : 25°C)

Item	Symbol	Conditions	Rank	Min.	Typ.	Max.	Unit	
Forward Voltage (*)	V_F	$I_F = 50 \text{ mA}$	AE	E1	1.95	-	2.10	V
			E2	2.10	-	2.25		
			E3	2.25	-	2.40		
			E4	2.40	-	2.55		
Reverse Current	I_R	$V_R = 5 \text{ V}$	-	-	-	10	μA	

Dominant Wavelength

(T_a : 25°C)

Item	Symbol	Condition	Rank	Model Name	Min.	Typ.	Max.	Unit	
Dominant Wavelength (*)	λ_D	$I_F = 50 \text{ mA}$	FC	C1	SPMRED3215A0AEC1SC	616	-	620	nm
				C2	SPMRED3215A0AEC2SC	620	-	624	

Luminous Intensity

(T_a : 25°C)

Item	Symbol	Condition	Rank	Min.	Typ.	Max.	Unit	
Luminous Intensity (*)	I_v	$I_F = 50 \text{ mA}$	SC	AB	1400	-	1800	mcd
				BA	1800	-	2100	
				BB	2100	-	2400	
				CA	2400	-	3000	

- * Tolerance : V_F ; $\pm 0.1\text{V}$, λ_D ; $\pm 2\text{nm}$, I_v ; $\pm 10\%$
- * Luminous Flux : Typ. 5000 mlm
- * Luminous intensity measuring equipment : CAS140CT

※ Approved Rank

V_F	λ_D	I_v
E1, E2, E3, E4	C1, C2	AB,BA,BB,CA

- * Each reel contains only one of the E1, E2, E3 or E4, a segment (1/4) of the V_F rank.
- * Each reel contains only one of the C1, C2 a segment (1/2) of the λ_D rank.
- * Each reel contains only one of the AB, BA, BB or CA a segment (1/4) of the I_v rank.

4. Typical Characteristics Graph

* These graphs show typical values.

(Ta : 25°C)

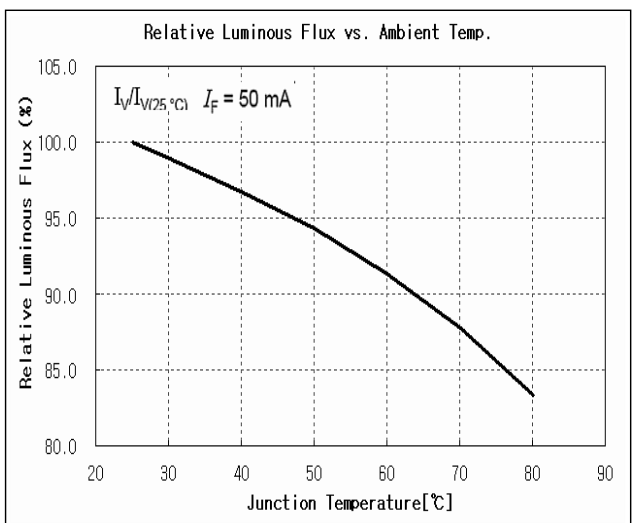
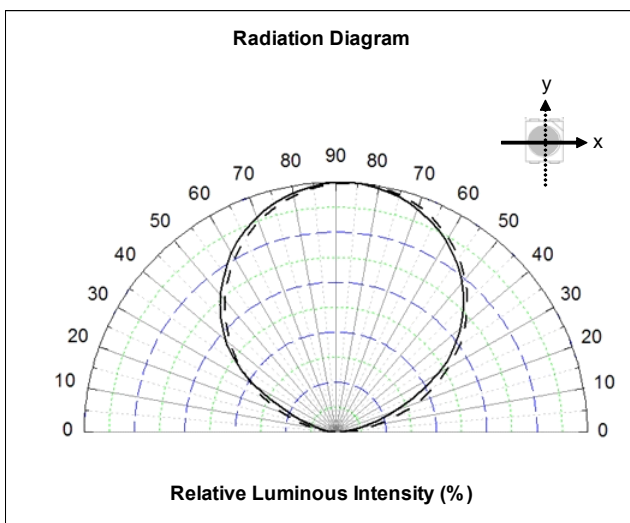
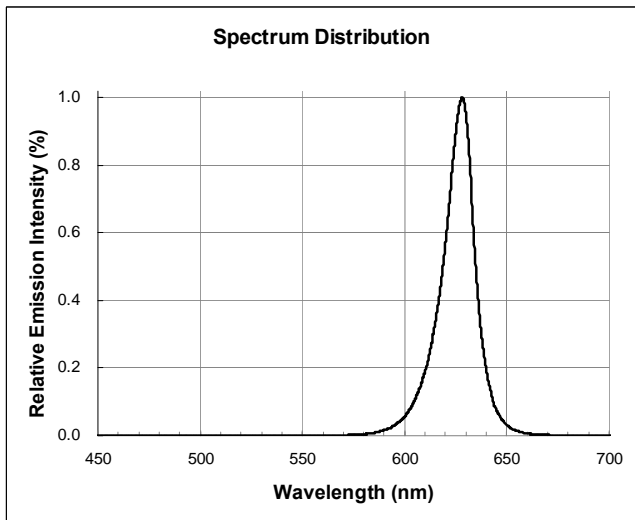
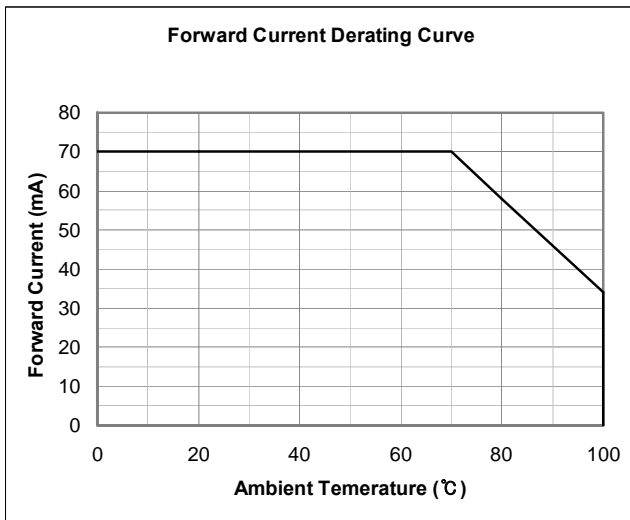
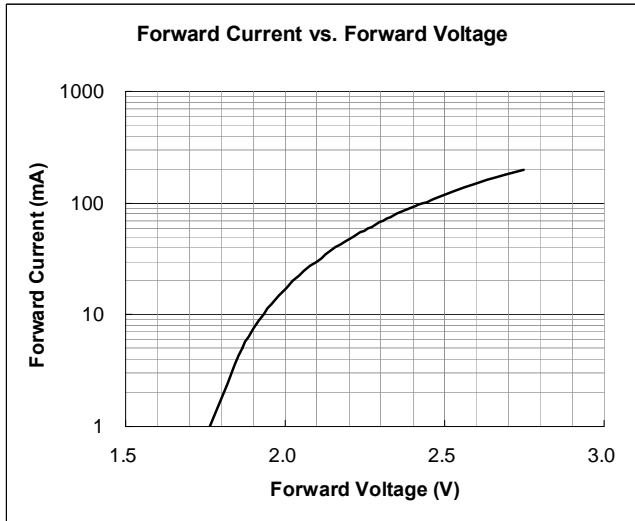
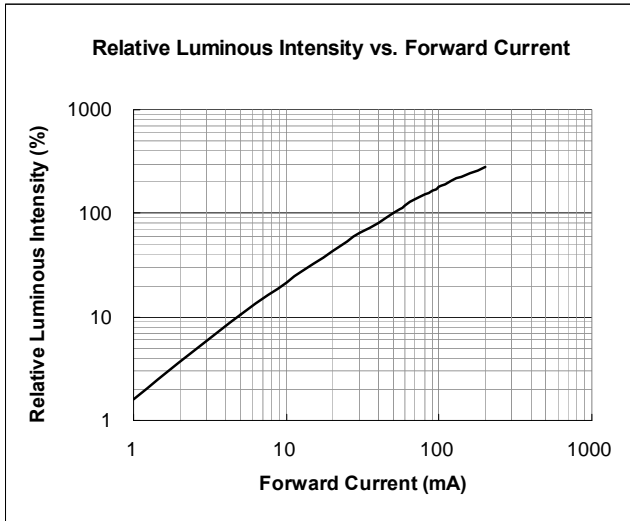

5. LED Package Outline Dimensions

unit:mm
Tolerance:±0.15

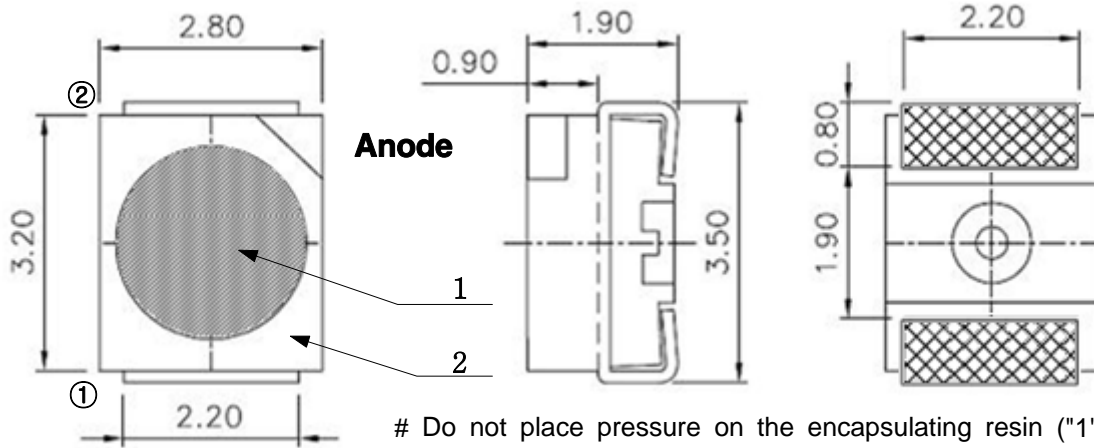

Do not place pressure on the encapsulating resin ("1")
The maximum compressing force is 15N on the polymer ("2")

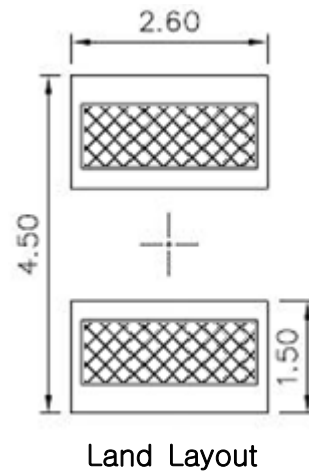
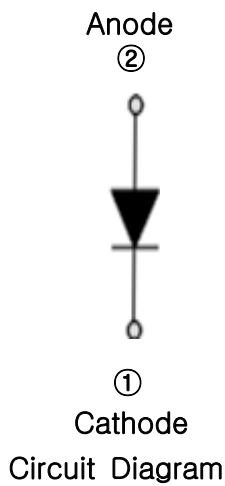

Do not place pressure on the encapsulating resin ("A")
The maximum compressing force is 15N on the polymer ("B")

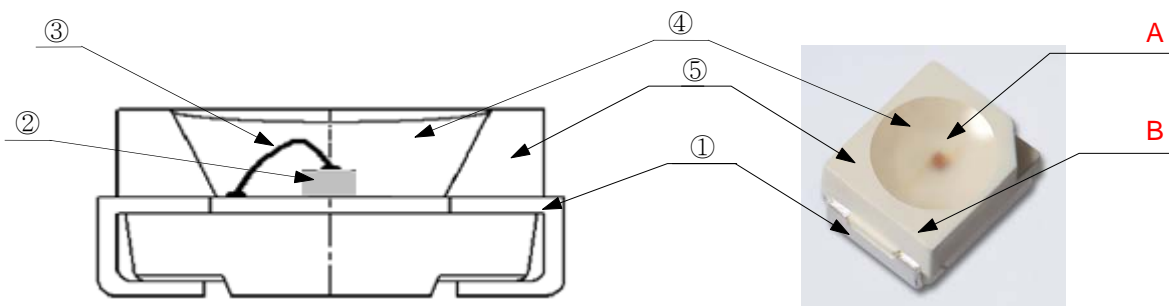

NUMBER	ITEM	MATERIAL
①	FRAME	Copper Frame(Silver Plated)
②	LED CHIP	AlGaInP/AlN
③	WIRE	Gold Wire
④	RESIN	Resin
⑤	PACKAGE	Heat-resistant Polymer

6. Reliability Test Items and Conditions

1) Test Items

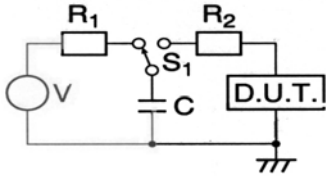
Test Item	Test Conditions	Hours/Cycles	Sample
Room Temp. Life Test [JESD22-A108]	25°C±3°C, DC 70 mA	1000 hr	0/3*30
High Temp. Humidity Life Test [JESD22-A101]	85°C±3°C, 85%±2%RH, DC 5 mA	1000 hr	0/3*30
High Temp. Life Test [JESD22-A108]	85°C±3°C, DC 50 mA	1000 hr	0/50
	100°C±3°C, DC 35 mA	1000 hr	0/50
Low Temp. Life Test [JESD22-A108]	-40°C±3°C, DC 70 mA	1000 hr	0/50
High Temp. Storage	100°C±3°C	1000 hr	0/50
Low Temp. Storage	-40°C±3°C,	1000 hr	0/50
High Temp. Humidity Storage	85°C±3°C, 85%±2%RH	1000 hr	0/50
Thermal Shock [JESD22-A104]	-40°C ~ 100°C [15min, 15min]	1000 cycles	0/3*30
Power Temp. Cycle [JESD22-A105]	-40°C/85°C, on/off 5min, DC 50 mA	1000 hr	0/50
Temp. Humidity Cycle Test	25°C ~ 65°C ~ -10°C 24hrs/1cycle, 95%RH	1000 hr	0/50
Pulse Life Test [JESD22-A114]	25°C±3°C, I _{FP} 100 mA [Duty 3.3/100 Pulse Width(T) 3.03 msec]	1000 hr	0/50
Reflow Soldering [JESD22-A113]	Peak 260°C±5°C for 10sec	3 times	0/3*30
ESD(Human Body Model) [JESD22-A114]	ESD 2kV  -R1:10 MΩ , R2:1.5 kΩ , C:100 pF	1 time	0/3*30
Mechanical Shock Test [MIL-STD-883 (2002 Con. B)]	3 shocks each X-Y-Z axis, 3000g, 0.3ms	1 time	0/11
Vibration Test [SAE 575 DEC88 Section 4.1]	10 to 55Hz , 1mm peak-to-peak, 2 minutes per cycles, 60 minutes total duration	1 time	0/11

2) Criteria for Judging the Damage

Item	Symbol	Test Condition	Limit	
			Min.	Max.
Forward Voltage	V_F	$I_F = 50 \text{ mA}$	-	U.S.L.*1.2
Luminous Intensity	I_v	$I_F = 50 \text{ mA}$	L.S.L.*0.7	-

* USL : Upper Standard Level LSL : Lower Standard Level

7. Solder Conditions

1) Reflow Conditions (Pb Free)

Reflow Frequency : 2 times max.

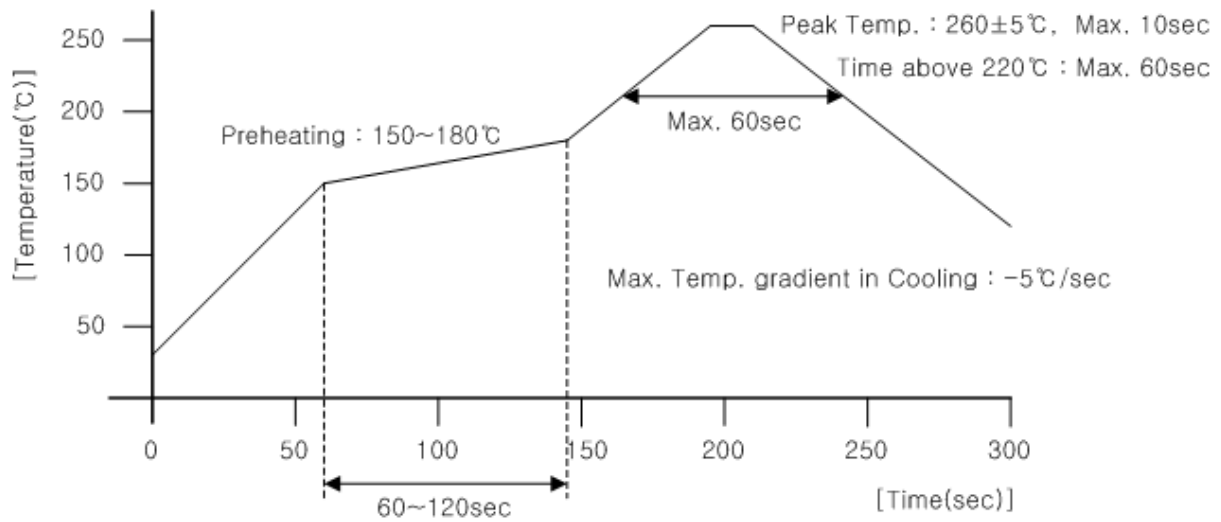

2) For Manual Soldering

Not more than 5 seconds @MAX300°C, under soldering iron.(one time only)

8. Taping Dimension

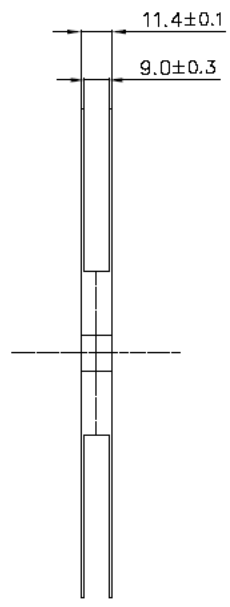
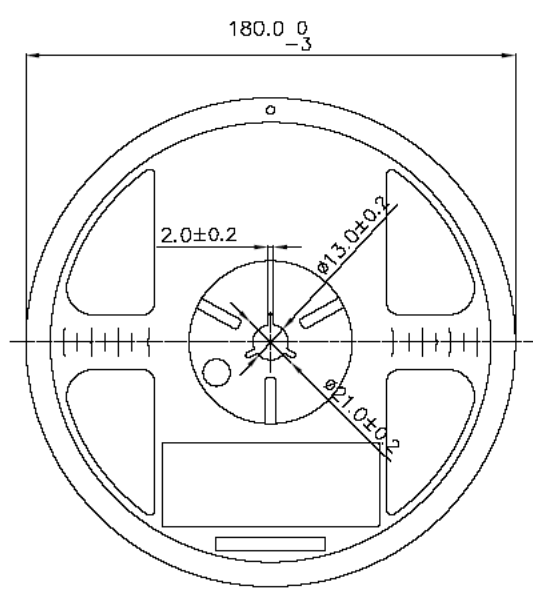
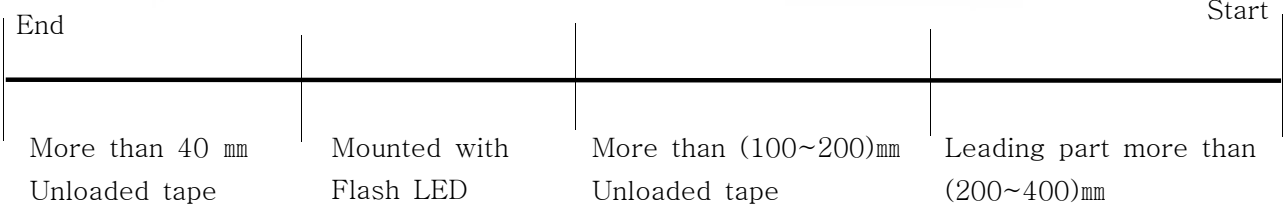
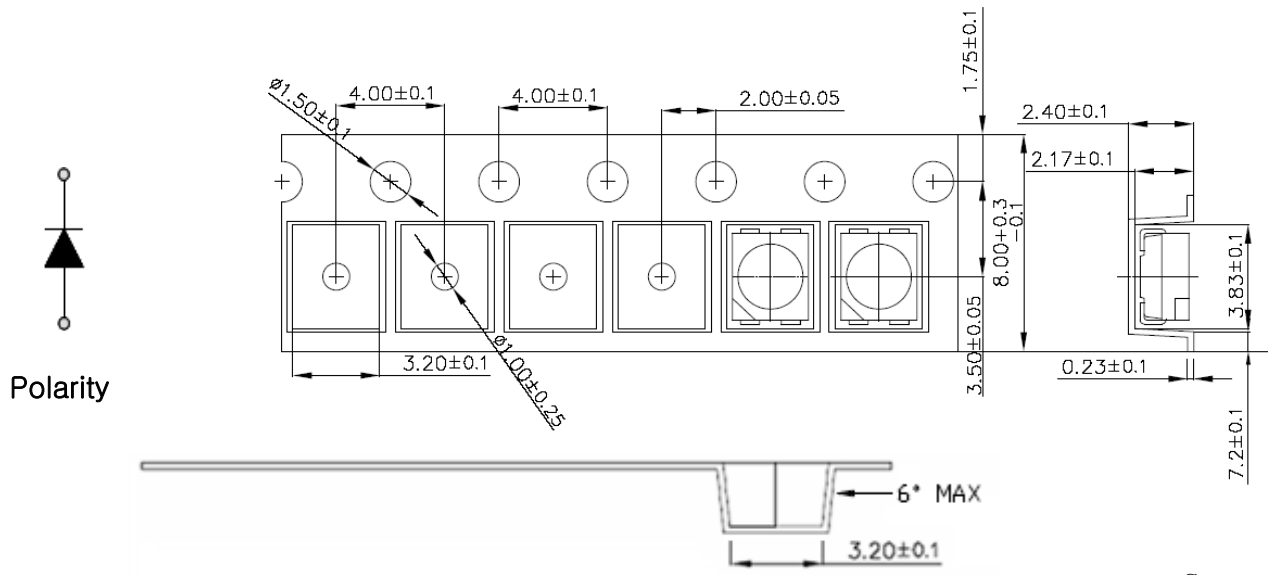

Tolerance ±0.2 , Unit:mm

- (1) Quantity : The quantity/reel to be 2000pcs.
- (2) Cumulative Tolerance : Cumulative tolerance/10 pitches to be ±0.2 mm
- (3) Adhesion Strength of Cover Tape : Adhesion strength to be 0.1–0.7N when the cover tape is turned off from the carrier tape at 10° angle to be the carrier tape.
- (4) Packaging : P/N, Manufacturing data code no. and quantity to be indicated on a damp proof package.

9. Label Structure

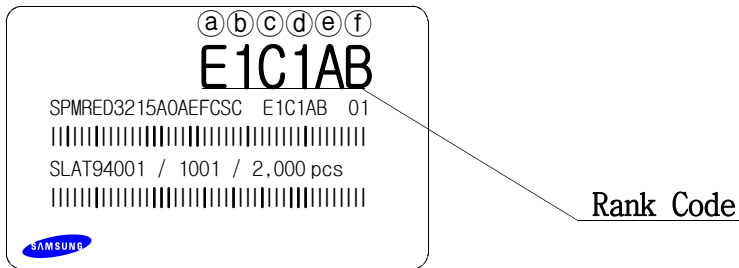

N.B) Denoted rank is the only example.

Rank Code

- ⒶⒷ : Forward Voltage(V_F) Rank (refer to page. 3)
- ⒸⒹ : Wavelength Rank(λ_D) (refer to page. 3)
- ⒺⒻ : Luminous Intensity(I_V) Rank (refer to page. 3)

10 Lot Number

The Lot number is composed of the following characters

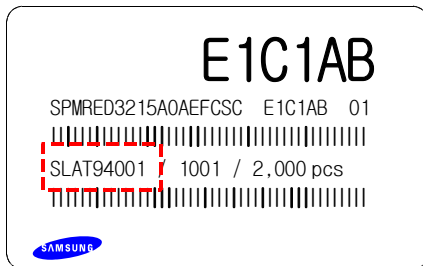

①②③④⑤⑥⑦⑧⑨ / 1ⒶⒷⒸ / 2,000 PCS

- ① : Production Site (S:SAMSUNG LED, G: GOSIN CHINA, I: Apro)
- ② : L (LED)
- ③ : Product State (A:Normality, B:Bulk, C:First Production, R:Reproduction, S:Sample)
- ④ : Year (T:2009, U:2010, V:2011...)
- ⑤ : Month (1 ~ 9, A, B)
- ⑥ : Day (1 ~ 9, A, B ~ V)
- ⑦⑧⑨ : SAMSUNG LED Product number (1 ~ 999)
- ⒶⒷⒸ : Reel Number (1 ~ 999)

11. Reel Packing Structure

Reel

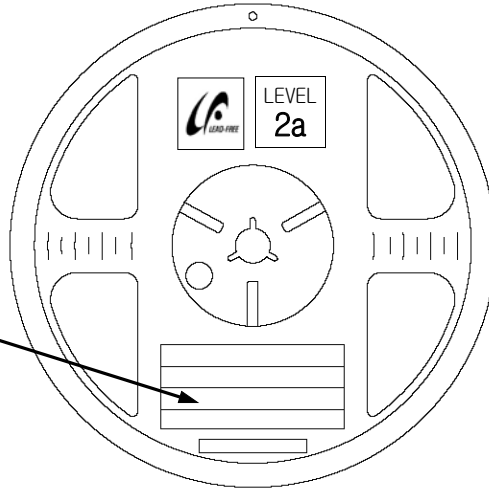
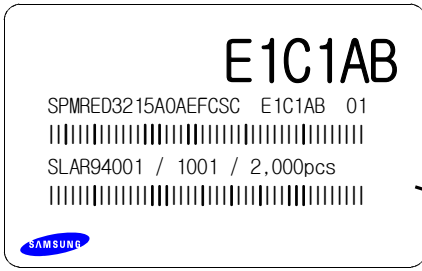

Aluminum Vinyl Bag

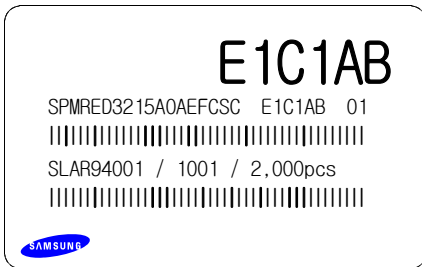

Material : Paper(SW3B(B))

TYPE	SIZE(mm)		
	L	W	H
7inch	245	220	182

① SIDE

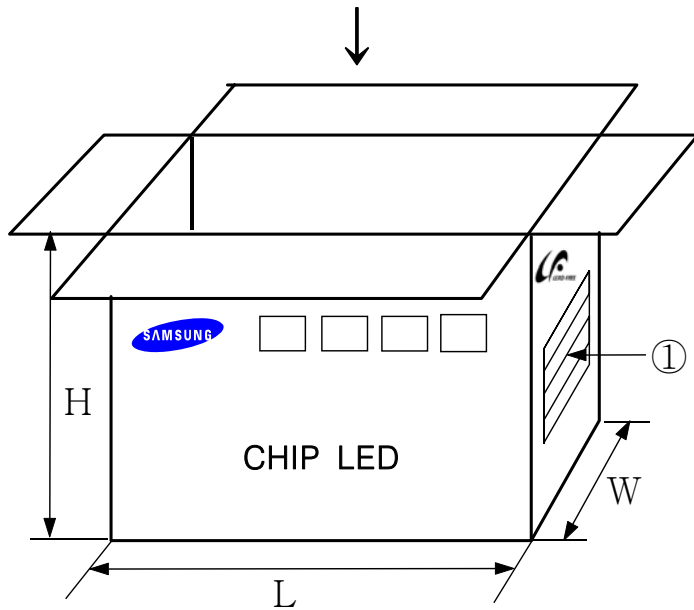
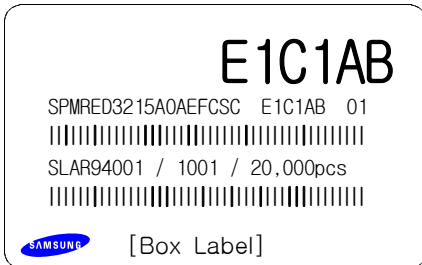

12. Aluminum Vinyl Bag



CAUTION

This bag contains
MOISTURE SENSITIVE DEVICES

LEVEL

2a

1. Shelf life in sealed bag: 12 months at <math>< 40^{\circ}\text{C}</math> and <math>< 90\%</math> relative humidity (RH)
2. Peak package body temperature: 240°C
3. After this bag is opened, devices that will be subjected to reflow solder or other high temperature processes must be:
 - a. Mounted within 672 hours at factory conditions of equal to or less than 30°C / 60% RH, or
 - b. Stored at <math>< 10\%</math> RH
4. Devices require bake, before mounting, if:
 - a. Humidity Indicator Card is > 65% when read at $23 \pm 5^{\circ}\text{C}$, or
 - b. 2a is not met.
5. If baking is required, devices must be baked for 1 hours at $60 \pm 5^{\circ}\text{C}$

Note: if device containers cannot be subjected to high temperature or shorter bake times are desired, reference IPC/JEDEC J-STD-033 for bake procedure,

Bag seal due date: _____
(if blank, see code label)

Note: Level and body temperature by IPC/JEDEC J-STD-020

E1C1AB

SPMRED3215A0AEFCSC E1C1AB 01

|||||

SLAR94001 / 1001 / 2,000pcs

|||||



주의 사항

이 알루미늄 지퍼 백은 습기 및 정전기로부터 제품을 보호하기 위하여 제작되었습니다. 개봉 후에는 즉시 솔더 작업을 실시하는 것을 권장합니다.

습기 및 정전기로부터 제품을 보호 하기 위해서 개봉 후 사용하지 않는 자재는 본 팩에 넣어 보관 하시기 바랍니다. 사용하지 않는 자재를 본 팩에 넣을 때는 반드시 동봉된 드라이 팩과 함께 넣고 지퍼부분을 완전하게 밀봉하여 주시기 바랍니다.

Important

This Al Zipper bag is designed to protect the enclosed products from moisture and ESD. Once opened, the products should be soldered onto the printed circuit board immediately. When not in use, please do not leave the products unprotected by the Al Zipper Bag. To repack unused products., please ensure the zip-lock is completely sealed with the dry pack left inside.

Silica gel & Humidity Indicator Card in Aluminum Vinyl Bag

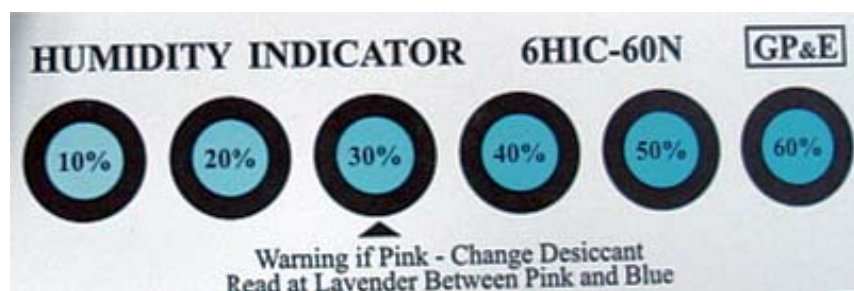

13. Precaution for Use

- 1) For over-current-proof function, customers are recommended to apply resistors to prevent sudden change of the current caused by slight shift of the voltage.
- 2) This device should not be used in any type of fluid such as water, oil, organic solvent, etc. When washing is required, IPA is recommended to use.
- 3) When the LEDs illuminate, operating current should be decided after considering the ambient maximum temperature.
- 4) LEDs must be stored in a clean environment.
If the LEDs are to be stored for 3 months or more after being shipped from SAMSUNG, they should be packed by a sealed container with nitrogen gas injected. (Shelf life of sealed bags: 12 months, temp. 0~40°C, 20~70%RH)
- 5) After storage bag is open, device subjected to soldering, solder reflow, or other high temperature processes must be:
 - a. Mounted within 168 hours (7 days) at an assembly line with a condition of no more than 30°C/60%RH,
 - b. Stored at <10% RH
- 6) Repack unused Products with anti-moisture packing, fold to close any opening and then store in a dry place.
- 7) Devices require baking before mounting, if humidity card reading is >60% at 23±5°C.
- 8) Devices must be baked for 24hours at 65±5°C, if baking is required.
- 9) The LEDs are sensitive to the static electricity and surge. It is recommended to use a wrist band or anti-electrostatic glove when handling the LEDs.

If voltage exceeding the absolute maximum rating is applied to LEDs, it may cause damage or even destruction to LED devices.

Damaged LEDs may show some unusual characteristics such as increase in leak current, lowered turn-on voltage, or abnormal lighting of LEDs at low current.

14. Hazard Substance Analysis

Test Report No. F690501/LF-CTSAYAA08-28294

Issued Date: October 22, 2008

Page 1 of 3
To: SAMSUNG ELECTRO-MECHANICS CO., LTD.
 314, Maetan3-dong
 Yeongtong-gu
 Suwon-city
 GYEONGGI-DO 442-373
 Korea

The following merchandise was submitted and identified by the client as :

Product Name : LED
SGS File No. : AYAA08-28294
Received Date : October 16, 2008
Test Performing Date : October 17, 2008
Test Performed : SGS Testing Korea tested the sample(s) selected by applicant with following results
Test Results : For further details, please refer to following page(s)
Comments : By the applicant's specific request, the sampling and testing was performed only for the part indicated in the photo without disassembly

 Pluto Kim
 Monet Jeong
 Billy Oh / Testing Person

SGS Testing Korea Co. Ltd.

Jeff Jang / Chemical Lab Mgr

*This document is issued by the Company under its General Conditions of Service printed overleaf or available on request and accessible at http://www.sgs.com/terms_and_conditions.htm. Attention is drawn to the limitation of liability, indemnification and jurisdiction issues defined therein. Any holder of this document is advised that information contained hereon reflects the Company's findings at the time of its intervention only and within the limits of Client's instructions, if any. The Company's sole responsibility is to its Client and this document does not exonerate parties to a transaction from exercising all their rights and obligations under the transaction documents. Any unauthorized alteration, forgery or falsification of the content or appearance of this document is unlawful and offenders may be prosecuted to the fullest extent of the law. Unless otherwise stated the results shown in this test report refer only to the sample(s) tested. This document cannot be reproduced except in full, without prior approval of the Company.

F052 Version2

SGS Testing Korea Co., Ltd.

 322, The O valley, 555-9, Hoggie-dong, Dongan-gu, Anyang-si, Gyeonggi-do, Korea 431-080
 t +82 (0)31 4608 000 f +82 (0)31 4608 059 <http://www.sgslab.co.kr> www.kr.sgs.com/greenlab

Member of the SGS Group (Société Générale de Surveillance)



Test Report No. F690501/LF-CTSAYAA08-28294

Issued Date: October 22, 2008

Page 2 of 3

Sample No. : AYAA08-28294.001

Sample Description : LED

Item No./Part No. : 3528 RED

Heavy Metals

Test Items	Unit	Test Method	MDL	Results
Cadmium (Cd)	mg/kg	US EPA 3052(1996), US EPA 6010B(1996), ICP	0.5	N.D.
Lead (Pb)	mg/kg	US EPA 3052(1996), US EPA 6010B(1996), ICP	5	N.D.
Mercury (Hg)	mg/kg	US EPA 3052(1996), US EPA 6010B(1996), ICP	2	N.D.
Hexavalent Chromium (Cr VI)	mg/kg	US EPA 3080A(1996), US EPA 7196A(1992), UV	1	N.D.

Flame Retardants-PBBs/PBDEs

Test Items	Unit	Test Method	MDL	Results
Monobromobiphenyl	mg/kg	US EPA 3540C, GC/MS	5	N.D.
Dibromobiphenyl	mg/kg	US EPA 3540C, GC/MS	5	N.D.
Tribromobiphenyl	mg/kg	US EPA 3540C, GC/MS	5	N.D.
Tetrabromobiphenyl	mg/kg	US EPA 3540C, GC/MS	5	N.D.
Pentabromobiphenyl	mg/kg	US EPA 3540C, GC/MS	5	N.D.
Hexabromobiphenyl	mg/kg	US EPA 3540C, GC/MS	5	N.D.
Heptabromobiphenyl	mg/kg	US EPA 3540C, GC/MS	5	N.D.
Octabromobiphenyl	mg/kg	US EPA 3540C, GC/MS	5	N.D.
Nonabromobiphenyl	mg/kg	US EPA 3540C, GC/MS	5	N.D.
Decabromobiphenyl	mg/kg	US EPA 3540C, GC/MS	5	N.D.
Monobromodiphenyl ether	mg/kg	US EPA 3540C, GC/MS	5	N.D.
Dibromodiphenyl ether	mg/kg	US EPA 3540C, GC/MS	5	N.D.
Tribromodiphenyl ether	mg/kg	US EPA 3540C, GC/MS	5	N.D.
Tetrabromodiphenyl ether	mg/kg	US EPA 3540C, GC/MS	5	N.D.
Pentabromodiphenyl ether	mg/kg	US EPA 3540C, GC/MS	5	N.D.
Hexabromodiphenyl ether	mg/kg	US EPA 3540C, GC/MS	5	N.D.
Heptabromodiphenyl ether	mg/kg	US EPA 3540C, GC/MS	5	N.D.
Octabromodiphenyl ether	mg/kg	US EPA 3540C, GC/MS	5	N.D.
Nonabromodiphenyl ether	mg/kg	US EPA 3540C, GC/MS	5	N.D.
Decabromodiphenyl ether	mg/kg	US EPA 3540C, GC/MS	5	N.D.

- NOTE: (1) N.D. = Not detected,(<MDL)
 (2) mg/kg = ppm
 (3) MDL = Method Detection Limit
 (4) - = No regulation
 (5) ** = Qualitative analysis (No Unit)
 (6) Negative = Undetectable / Positive = Detectable

*This document is issued by the Company under its General Conditions of Service printed overleaf or available on request and accessible at http://www.sgs.com/terms_and_conditions.htm. Attention is drawn to the limitation of liability, indemnification and jurisdiction issues defined therein. Any holder of this document is advised that information contained hereon reflects the Company's findings at the time of its intervention only and within the limits of Client's instructions, if any. The Company's sole responsibility is to its Client and this document does not exonerate parties to a transaction from exercising all their rights and obligations under the transaction documents. Any unauthorized alteration, forgery or falsification of the content or appearance of this document is unlawful and offenders may be prosecuted to the fullest extent of the law. Unless otherwise stated the results shown in this test report refer only to the sample(s) tested. This document cannot be reproduced except in full, without prior approval of the Company.



Test Report No. F690501/LF-CTSAYAA08-28294

Issued Date: October 22, 2008

Page 3 of 3

Sample No. : AYAA08-28294.001

Sample Description : LED

Item No./Part No. : 3528 RED

Halogen Contents

Test Items	Unit	Test Method	MDL	Results
Bromine(Br)	mg/kg	EN 14582:2007 , IC	30	N.D.
Chlorine(Cl)	mg/kg	EN 14582:2007 , IC	30	N.D.

Picture of Sample as Received:

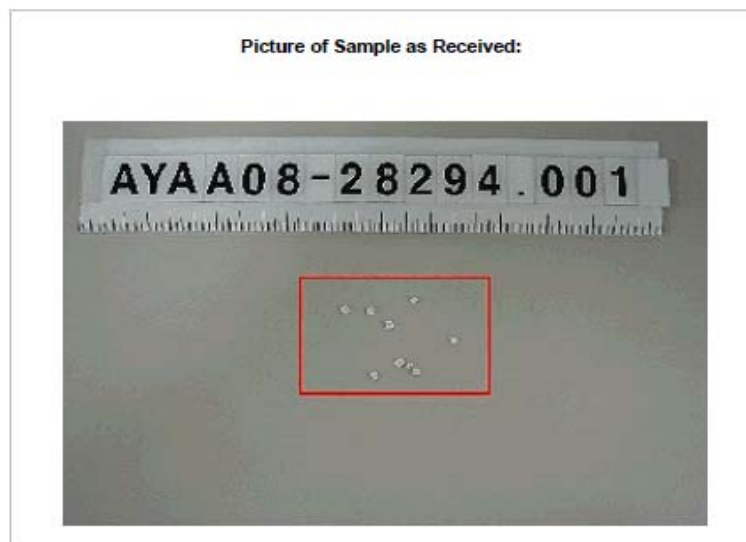

*** End ***

- NOTE:**
- (1) N.D. = Not detected.(<MDL)
 - (2) mg/kg = ppm
 - (3) MDL = Method Detection Limit
 - (4) - = No regulation
 - (5) ** = Qualitative analysis (No Unit)
 - (6) Negative = Undetectable / Positive = Detectable

*This document is issued by the Company under its General Conditions of Service printed overleaf or available on request and accessible at http://www.sgs.com/terms_and_conditions.html. Attention is drawn to the limitation of liability, indemnification and jurisdiction issues defined therein. Any holder of this document is advised that information contained hereon reflects the Company's findings at the time of its intervention only and within the limits of Client's instructions, if any. The Company's sole responsibility is to its Client and this document does not exonerate parties to a transaction from exercising all their rights and obligations under the transaction documents. Any unauthorized alteration, forgery or falsification of the content or appearance of this document is unlawful and offenders may be prosecuted to the fullest extent of the law. Unless otherwise stated the results shown in this test report refer only to the sample(s) tested. This document cannot be reproduced except in full, without prior approval of the Company.

