

DATE OF ISSUE : 2009. 04. 13

SPECIFICATION

MODEL : SLHNNR0521N0S0Q0E3

[Rank : (S0), (Q1, Q2), (E1, F1, G1)]

HIGH POWER LED – SUNNIX5

CUSTOMER : _____

CUSTOMER		
CHECKED	CHECKED	APPROVED
Preliminary		

SAMSUNG LED			
DRAWN	CHECKED(Sales)	CHECKED(Quality)	APPROVED

SAMSUNG LED CO.,LTD.
314, MAETAN3-DONG, YEONGTONG-GU,
SUWON-SI, GYEONGGI-DO, KOREA, 443-743

Contents

1.	Product Outline	3
2.	Absolute Maximum Rating	3
3.	Characteristics	3
4.	Typical Characteristic Graphs	4
5.	Outline Drawing and Dimension	5
6.	Package Structure	6
7.	Solder Conditions	6
8.	Reliability Test Items and Conditions	7
9.	Taping Dimension	8
10.	Label Structure	9
11.	Lot Number	9
12.	Reel Packing Structure	10
13.	Precaution for Use	12
14.	Hazard Substance Analysis	14
15.	Revision History	17

1. Product Outline

1) Features

- Plastic Molded Lead Frame Type : 7.0 mm(L), 7.0 mm(W), 2.0 mm(T)
- Beam View Angle($\Delta\theta$)* : 115 °
- High Power / Brightness Chip & Long Time Reliability

2) Applications

- Automotive Interior Lamp, Illumination etc.

※ View Angle describes the spatial intensity distribution and is the difference between the angles corresponding to 50% of the maximum intensity.

2. Absolute Maximum Rating

- Operation Forward Current 700 mA
- Reverse Voltage* 5 V
- Thermal Resistance ($R_{th\ j-s}$) \cong 6 °C/W
- Operating Temperature Range (T_{OPR}) -40 °C ~ 85 °C
- Storage Temperature Range (T_{STG}) -40 °C ~ 110 °C
- LED Junction Temperature (T_j) 115 °C

※ Does not operate in the reverse direction.

3. Characteristics

1) Electrical properties ($T_j = 25\text{ °C}$)

Parameter	Symbol	Condition	Rank	Min.	Typ.	Max.	Unit
Reverse Current	I_R	$V_R = 10\text{ V}$	-	-	-	5.0	μA
Forward Voltage	V_F	$I_F = 350\text{ mA}$	S0	1.9	-	3.1	V

2) Dominant Wavelength ($T_j = 25\text{ °C}$)

Rank		Symbol	Condition	Min.	Max.	Unit
Q0	Q1	W_D	$I_F = 350\text{ mA}$	610	615	nm
	Q2			615	620	

3) Luminous Flux ($T_j = 25\text{ °C}$)

Rank		Symbol	Condition	Min.	Typ.	Max.	Unit
E3	E1	Φ_V	$I_F = 350\text{ mA}$	40	-	50	lm
	F1			50	-	60	
	G1			60	-	70	

※ Tolerance : $V_F : \pm 0.1$, $\Phi_V : \pm 10\%$, $W_D : \pm 1\text{ nm}$

Approved Rank

Symbol	V_F	W_D	Φ_V
Rank	S0	Q1, Q2	E1, F1, G1

4. Typical Characteristic Graphs

$T_j = 25\text{ }^\circ\text{C}$

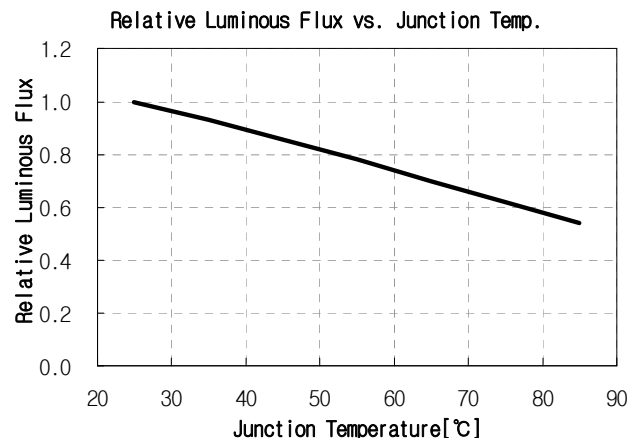
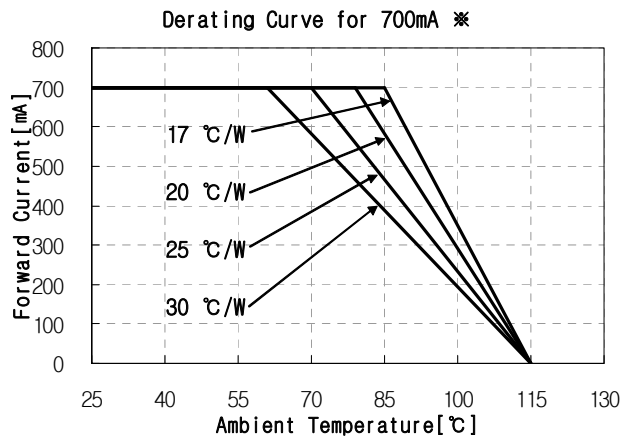
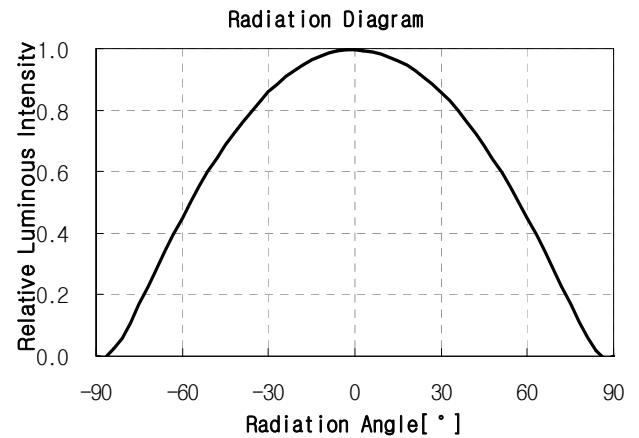
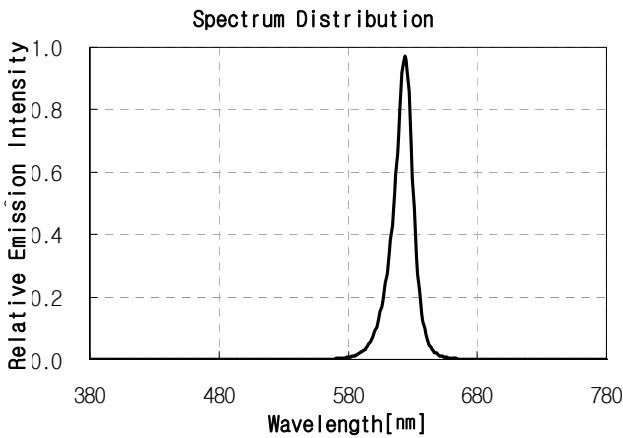
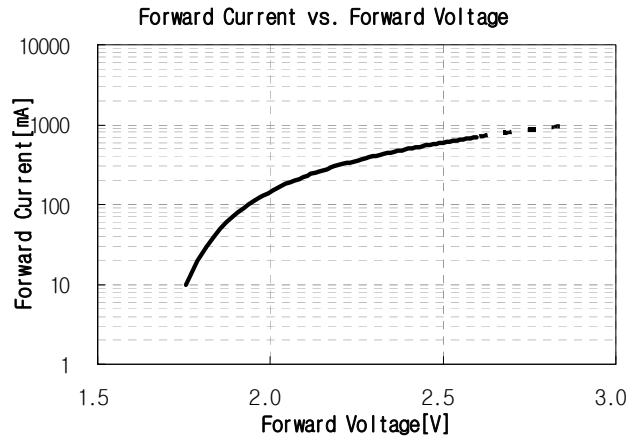
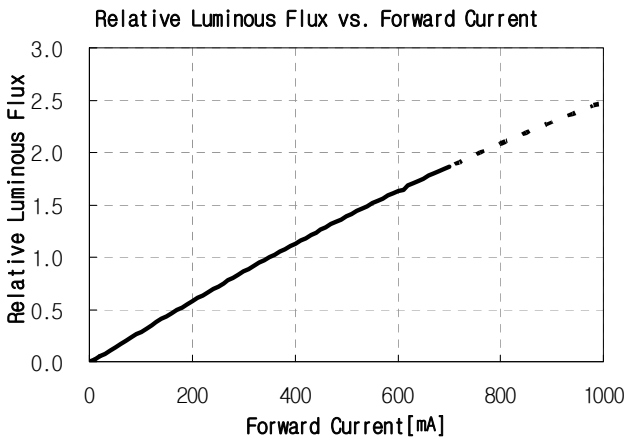

※ Thermal Resistance Test Conditions

- Junction to ambient thermal resistance
- JEDEC Standard JESD 51-2,3

JESD 51-2 : Integrated Circuits Thermal Test Method Environmental Conditions

- Natural Convection (Still Air)

JESD 51-3 : Low Effective Thermal Conductivity Test Board for Leaded Surface Mount Package

5. Outline Drawing and Dimension

Unit : mm
Tolerance : ± 0.1

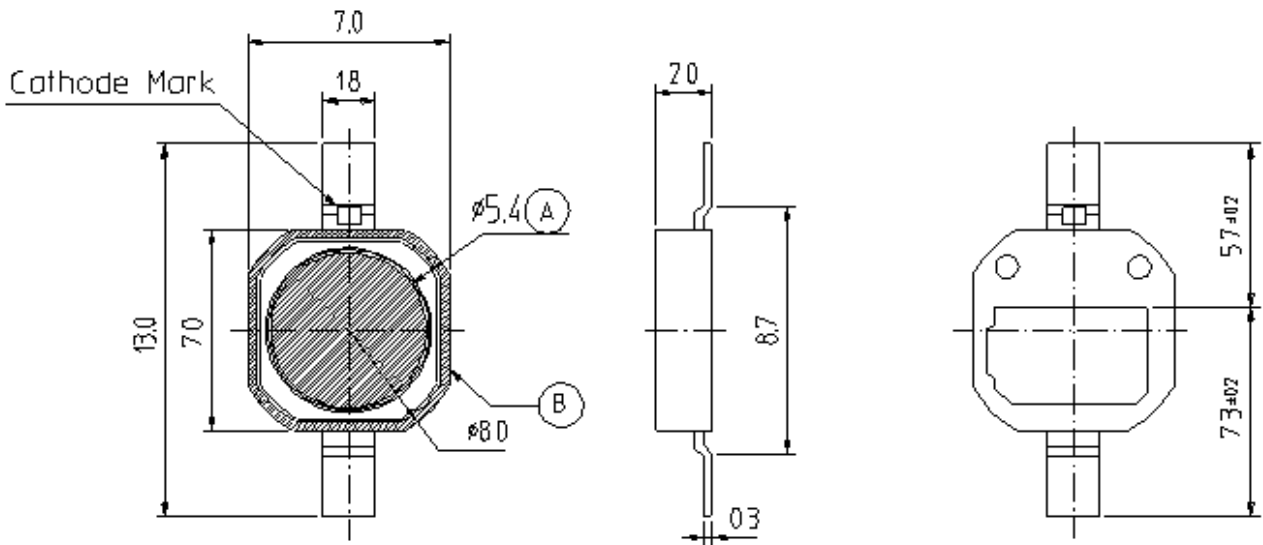

Pick and Place

1. Do not place pressure on the encapsulating resin ("A")
It is recommended to use a pick & place nozzle with inside diameter of 5.8mm
2. The maximum compressing force is 15N on the polymer ("B")

Circuit

Cathode



Anode

Solder Pattern for Surface Mount

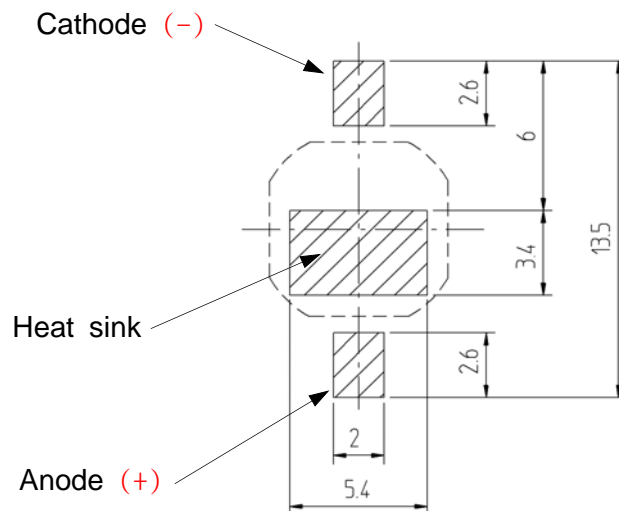

Remarks

Make sure that the heat sink is electrically connected to the Anode.
Heat sink is to be soldered, If not, use the heat conductive adhesive.

6. Package Structure

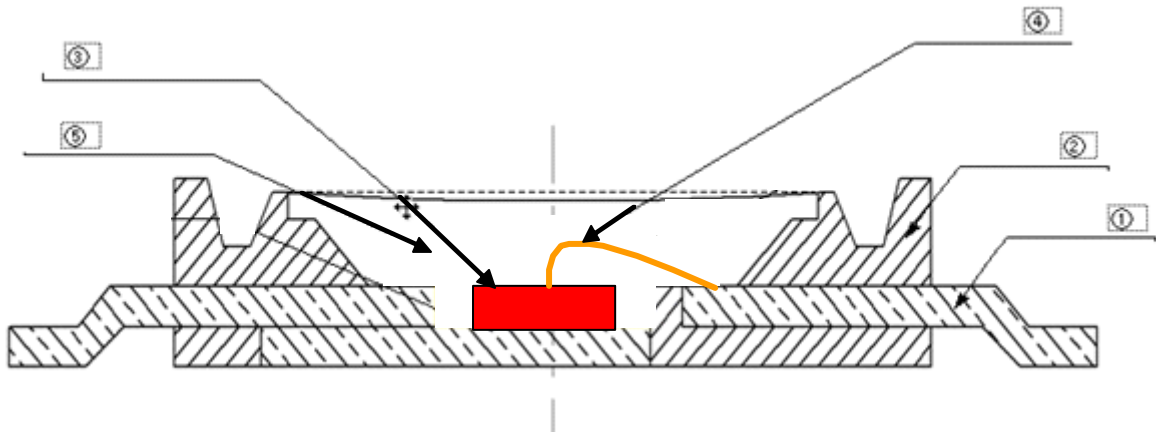

No	Component	Material
①	FRAME	Copper frame(Silver plated)
②	PACKAGE	Heat-resistant polymer
③	LED CHIP	AlGaInP
④	WIRE	Gold wire
⑤	RESIN	Silicone

7. Solder Conditions

1) Reflow Conditions (Pb-Free)

Reflow Frequency : 2 time max.

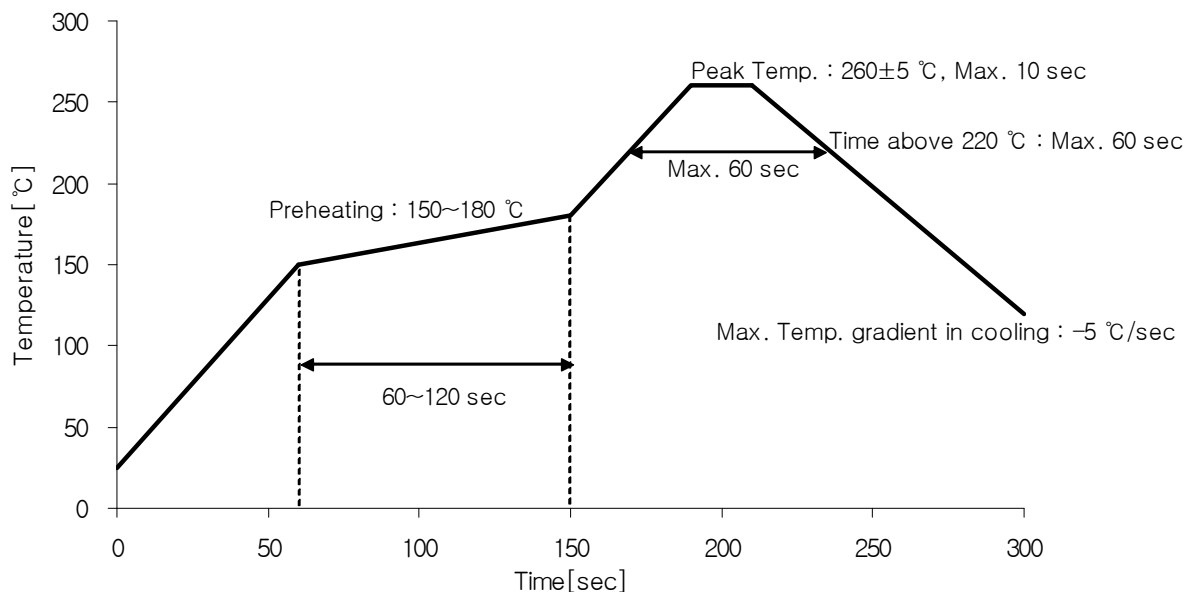

2) For Manual Soldering

Not more than 5 seconds @Max. 300 °C, under soldering iron.

8. Reliability Test Items and Conditions

1) Test Items

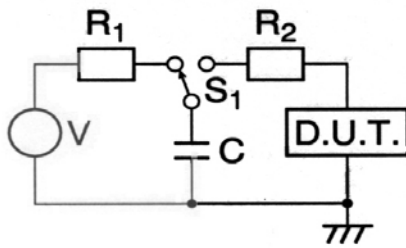
Test Items	Test Conditions	Test Hours/Cycles
Room Temperature life test	25 °C, $I_F = \text{Max DC}^*$	1,000 h
High Temperature humidity life test	85 °C, 85 % RH, $I_F = \text{Max DC}^*$	1,000 h
High Temperature life test	85 °C, $I_F = \text{Max DC}^*$	1,000 h
Low Temperature life test	-40 °C, $I_F = \text{Max DC}^*$	1,000 h
High Temperature Storage	110 °C	1,000 h
Low Temperature Storage	-40 °C	1,000 h
Thermal Shock	-40 / 120 °C, each 30 min	200 cycles
Temperature humidity Cycle On/Off test	-40 / 85 °C, each 20 min, 100 min transfer Power On/off each 5 min, DC 350 mA	100 cycles
Reflow (Pb-Free)	Peak 260±5 °C for 10 sec	3 times
ESD(HBM)	 <p>R1 : 10 MΩ , R2 : 1.5 kΩ , C : 100 pF</p>	3 times (± 5 kV)

* Max. DC current is depending on maximum current derating curve.

2) Criteria for Judging the Damage

Item	Symbol	Test Condition	Limit	
			Min	Max
Forward Voltage	V_F	$I_F = 350 \text{ mA}$	-	U.S.L.*1.2
Luminous Flux	Φ_V	$I_F = 350 \text{ mA}$	L.S.L.*0.5	-

* U.S.L : Upper Standard Level, L.S.L : Lower Standard Level

9. Taping Dimension

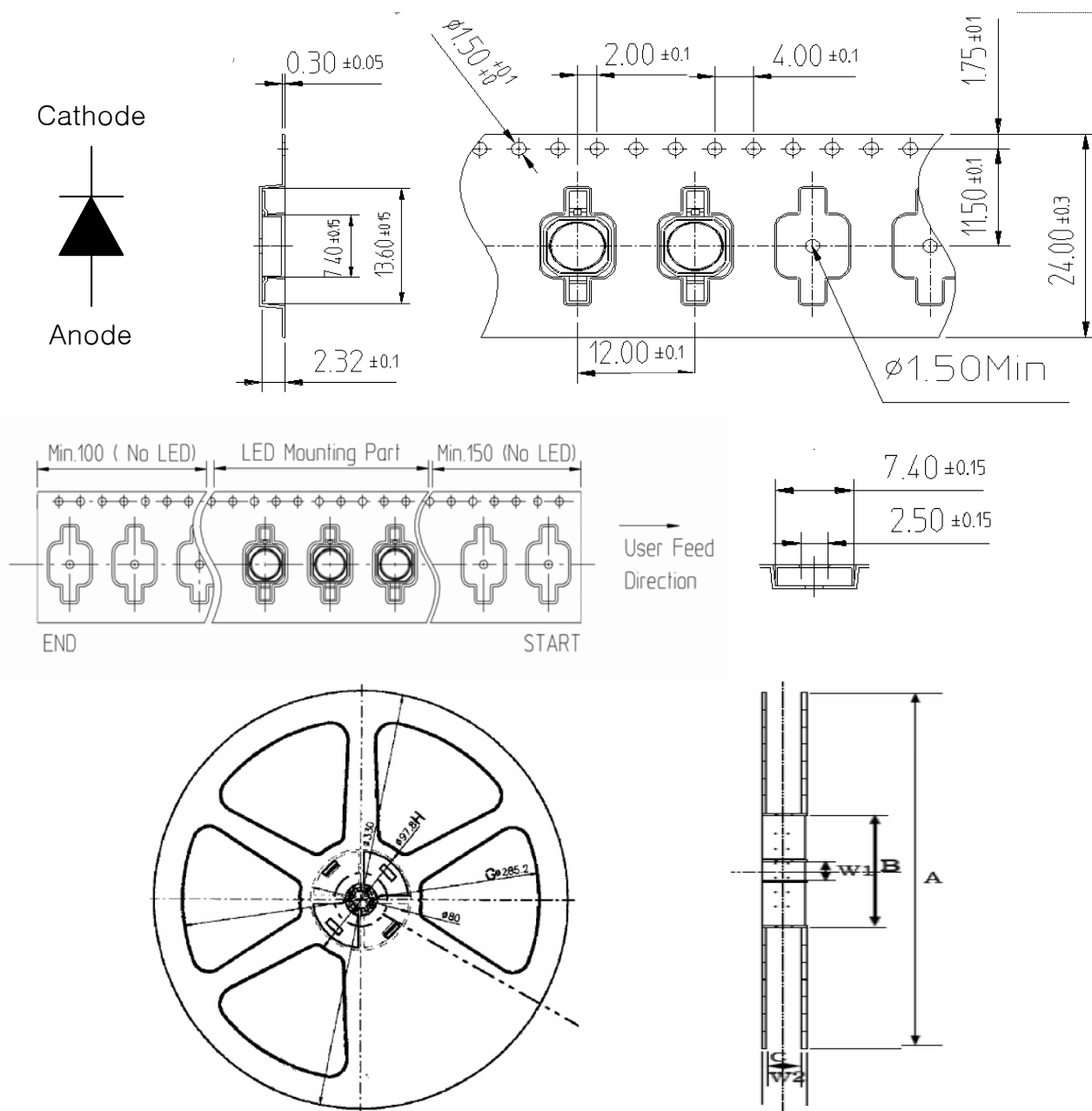

- (1) Quantity : 2,000 Pcs / 13" Reel.
- (2) Cumulative Tolerance : Cumulative Tolerance/10 pitches is less than ± 0.2 mm
- (3) Adhesion Strength of Cover Tape : Adhesion strength to be 0.1–0.7N when the cover tape is turned off from the carrier tape at 10 °C angle to be the carrier tape.
- (4) Packaging : P/N, Manufacturing data Code No. and quantity to be indicated on a damp proof Package

10. Label Structure

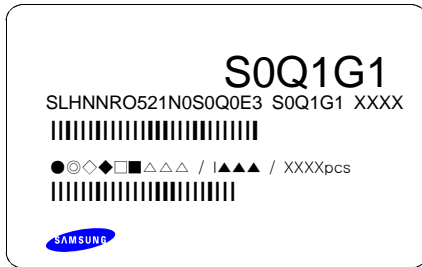

Rank Code

/S0/ : VF Rank (refer to page 3)

/Q1/ : Chromaticity Coordinate Rank, CIE (refer to page 3)

/G1/ : Luminous Flux (refer to page 3)

11. Lot Number

The Lot number is composed of the following characters

●◎◇◆□■△△△ / I▲▲▲ / 2000PCS

● : Production Site (S:SAMSUNG LED, G:Gosin China)

◎ : L (LED)

◇ : Product State (A:Normality, B:Bulk, C:First Production, R:Reproduction, S:Sample)

◆ : Year (S:2008, T:2009, U:2010...)

□ : Month (1 ~ 9, A, B)

■ : Day (1 ~ 9, A, B ~ V)

△ : SAMSUNG LED Product Number (1 ~ 999)

▲ : Reel Number (1 ~ 999)

12. Reel Packing Structure

1) Reel

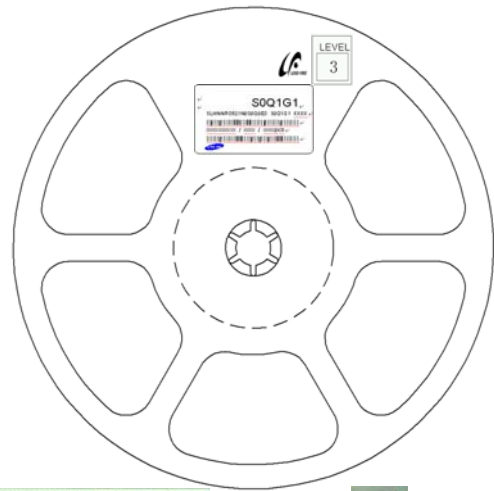

2) Aluminum Bag

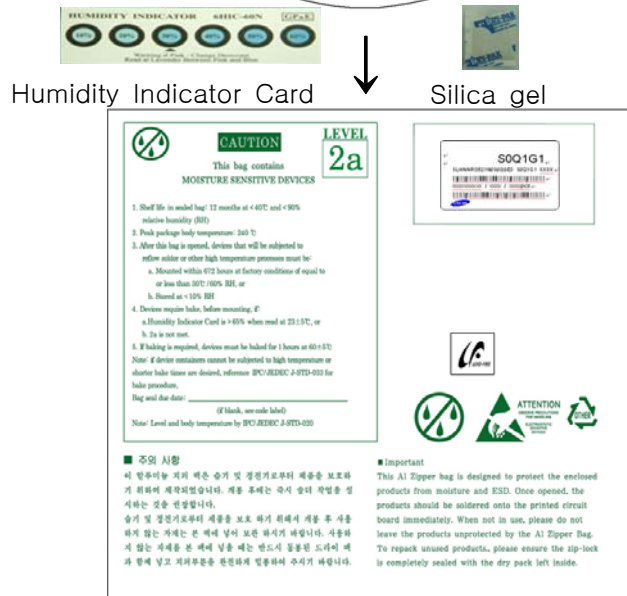
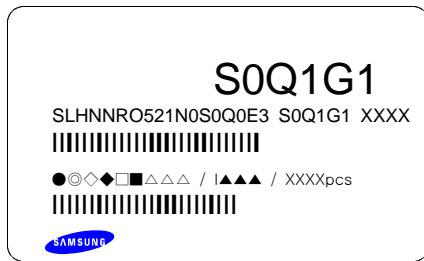

3) Inner Box

Material : Paper(SW3B(B))

TYPE	SIZE(mm)		
	L	W	H
13inch	335	45	335

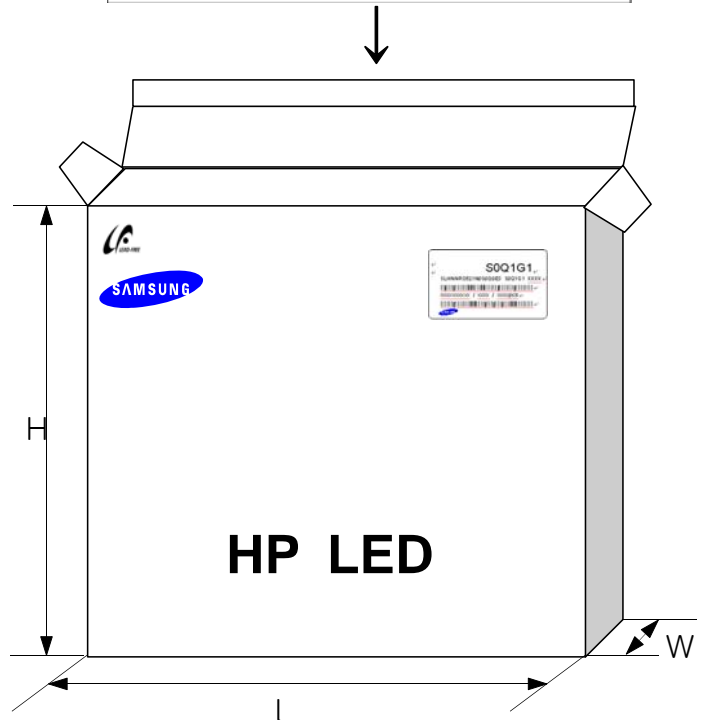
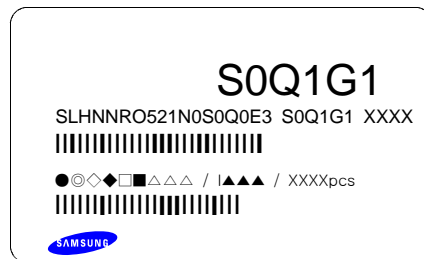

4) Carton Box

Material : Paper(SW3B(B))

TYPE	SIZE(mm)		
	L	W	H
13inch	350	350	350

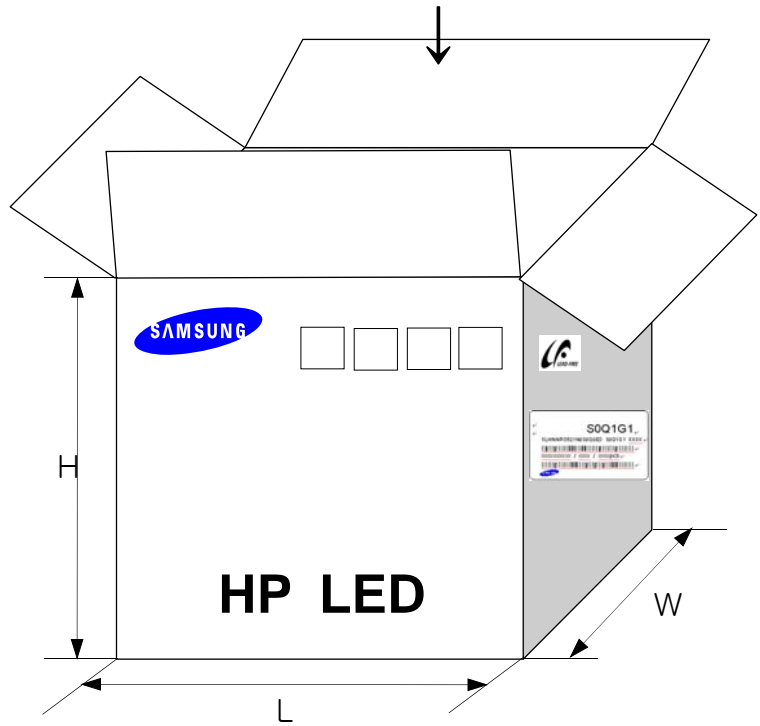

13. Precaution for Use

- 1) For over-current-proof function, customers are recommended to apply resistors to prevent sudden change of the current caused by slight shift of the voltage.
- 2) This device should not be used in any type of fluid such as water, oil, organic solvent, etc. When washing is required, IPA is recommended to use.
- 3) When the LEDs illuminate, operating current should be decided after considering the ambient maximum temperature.
- 4) LEDs must be stored in a clean environment. If the LEDs are to be stored for 3 months or more after being shipped from SAMSUNG LED, they should be packed by a sealed container with nitrogen gas injected. (Shelf life of sealed bags : 12 months, temp. 0~40°C, 20~70%RH)
- 5) After storage bag is open, device subjected to soldering, solder reflow, or other high temperature processes must be:
 - a. Mounted within 168 hours (7days) at an assembly line with a condition of no more than 30°C/60%RH,
 - b. Stored at <10% RH.
- 6) Repack unused Products with anti-moisture packing, fold to close any opening and then store in a dry place.
- 7) Devices require baking before mounting, if humidity card reading is >60% at 23±5°C.
- 8) Devices must be baked for 24hours at 65±5°C, if baking is required.
- 9) The LEDs are sensitive to the static electricity and surge. It is recommended to use a wrist band or anti-electrostatic glove when handling the LEDs.
 If voltage exceeding the absolute maximum rating is applied to LEDs, it may cause damage or even destruction to LED devices.
 Damaged LEDs may show some unusual characteristics such as increase in leak current, lowered turn-on voltage, or abnormal lighting of LEDs at low current.

- 10) When handling LED with tweezers, the LED Should only be held by the polymer body, not by the encapsulant or LENS.
- 11) The use of appropriate nozzle for the LED recommended. For the recommended nozzle size, refer to the figure at the below.
- 12) Do not stack assembled PCBs together. Since silicone is a soft material, abrasion between two PCB assembled with silicone encapsulated LED might cause catastrophic failure of the LEDs due to damage to encapsulant and wire and LED detachment.

14. Hazard Substance Analysis



Test Report No. F690501/LF-CTSAYAA09-01701R1

Issued Date: January 23, 2009 **Page 1 of 3**

To: SAMSUNG ELECTRO-MECHANICS CO., LTD.
 314, Maetan3-dong
 Yeongtong-gu
 Suwon-city
 GYEONGGI-DO 442-373
 Korea

The following merchandise was submitted and identified by the client as :

Product Name : LED
SGS File No. : AYAA09-01701R1
Received Date : January 16, 2009
Test Performing Date : January 19, 2009
Test Performed : SGS Testing Korea tested the sample(s) selected by applicant with following results
Test Results : For further details, please refer to following page(s)
Comments : By the applicant's specific request, the sampling and testing was performed only for the part indicated in the photo without disassembly. This Report supersedes the Report No. F690501/LF-CTSAYAA09-01701 dated January 23, 2009 issued by SGS Testing Korea Co., Ltd. The test result of Cd, Pb, Hg, Cr6+ are extracted from the test report number F690501/LF-CTSAYAA09-04859 where the sample is claimed to be identical.

Pluto Kim
 Cindy Park
 Jinee Song/ Testing Person

SGS Testing Korea Co. Ltd.

Jeff Jang / Chemical Lab Mgr

This document is issued by the Company subject to its General Conditions of Service printed elsewhere, available on request or accessible at www.sgstesting.com and www.sgs.com and to electronic format documents, subject to Terms and Conditions for Electronic Documents at www.sgstesting.com/electronic. Attention is drawn to the limitation of liability, indemnification and jurisdiction issues defined therein. Any failure of this document to adhere to the Minimum Standard format reflects the Company's liability in the form of its document only and shall be liable to Client's resolution, if any. The Company's sole responsibility is to its Client and this document does not constitute either a representation from nor a disclaimer from compliance with all laws, regulations and obligations under the contract documents. This document cannot be reproduced except in full, without prior written approval of the Company. Any unauthorized alteration, copying or distribution of the content is prohibited and may be prosecuted to the full extent of the law. Unless otherwise stated, the results shown in this test report refer only to the sample(s) tested and such sample(s) are retained for 90 days only.

Test Report No. F690501/LF-CTSAYAA09-01701R1

Issued Date: January 23, 2009

Page 2 of 3
Sample No. : AYAA09-01701R1.001

Sample Description : LED

Item No./Part No. : Red High Power LED

Heavy Metals

Test Items	Unit	Test Method	MDL	Results
Cadmium (Cd)	mg/kg	With reference to IEC 62321:2008, ICP-OES	0.5	N.D.
Lead (Pb)	mg/kg	With reference to IEC 62321:2008, ICP-OES	5	N.D.
Mercury (Hg)	mg/kg	With reference to IEC 62321:2008, ICP-OES	2	N.D.
Hexavalent Chromium (Cr VI)	mg/kg	With reference to IEC 62321:2008, UV-VIS	1	N.D.

Flame Retardants-PBBs/PBDEs

Test Items	Unit	Test Method	MDL	Results
Monobromobiphenyl	mg/kg	US EPA 3540C, GC/MS	5	N.D.
Dibromobiphenyl	mg/kg	US EPA 3540C, GC/MS	5	N.D.
Tribromobiphenyl	mg/kg	US EPA 3540C, GC/MS	5	N.D.
Tetrabromobiphenyl	mg/kg	US EPA 3540C, GC/MS	5	N.D.
Pentabromobiphenyl	mg/kg	US EPA 3540C, GC/MS	5	N.D.
Hexabromobiphenyl	mg/kg	US EPA 3540C, GC/MS	5	N.D.
Heptabromobiphenyl	mg/kg	US EPA 3540C, GC/MS	5	N.D.
Octabromobiphenyl	mg/kg	US EPA 3540C, GC/MS	5	N.D.
Nonabromobiphenyl	mg/kg	US EPA 3540C, GC/MS	5	N.D.
Decabromobiphenyl	mg/kg	US EPA 3540C, GC/MS	5	N.D.
Monobromodiphenyl ether	mg/kg	US EPA 3540C, GC/MS	5	N.D.
Dibromodiphenyl ether	mg/kg	US EPA 3540C, GC/MS	5	N.D.
Tribromodiphenyl ether	mg/kg	US EPA 3540C, GC/MS	5	N.D.
Tetrabromodiphenyl ether	mg/kg	US EPA 3540C, GC/MS	5	N.D.
Pentabromodiphenyl ether	mg/kg	US EPA 3540C, GC/MS	5	N.D.
Hexabromodiphenyl ether	mg/kg	US EPA 3540C, GC/MS	5	N.D.
Heptabromodiphenyl ether	mg/kg	US EPA 3540C, GC/MS	5	N.D.
Octabromodiphenyl ether	mg/kg	US EPA 3540C, GC/MS	5	N.D.
Nonabromodiphenyl ether	mg/kg	US EPA 3540C, GC/MS	5	N.D.
Decabromodiphenyl ether	mg/kg	US EPA 3540C, GC/MS	5	N.D.

- NOTE: (1) N.D. = Not detected.(<MDL)
 (2) mg/kg = ppm
 (3) MDL = Method Detection Limit
 (4) - = No regulation
 (5) ** = Qualitative analysis (No Unit)
 (6) Negative = Undetectable / Positive = Detectable

This document is issued by the Company subject to its General Conditions of Service printed elsewhere, available on request or accessible at www.sgs.com and www.sgs.com/sgsweb and, for electronic format documents, subject to Terms and Conditions for Electronic Documents at www.sgs.com/sgsweb/sgsweb.htm. Attention is drawn to the limitation of liability, indemnification and arbitration clause defined therein. Any failure of this document to address the attention required herein reflects the Company's liability in the line of its services only and under the laws of South Korea. In any case, the Company's sole responsibility is to its Client and this document does not constitute proof of a description from members of their rights and obligations under the applicable documents. This document cannot be reproduced except in full, without prior written approval of the Company. Any unauthorized alteration, copying or distribution of the content or appearance of this document is prohibited and offences may be prosecuted to the full extent of the law. Unless otherwise stated the results shown in this test report refer only to the samples tested and such samples are retained for 180 days only.

F052 Version3

SGS Testing Korea Co., Ltd.

 322, The O valley, 556-9, Hoggae-dong, Dongan-gu, Anyang-si, Gyeonggi-do, Korea 431-080
 T +82 (0)31 4908 000 F +82 (0)31 4908 059 <http://www.sgs.com> www.kr.sgs.com/sgsweb

Member of the SGS Group (Société Générale de Surveillance)



Test Report No. F690501/LF-CTSAYAA09-01701R1

Issued Date: January 23, 2009

Page 3 of 3

Sample No. : AYAA09-01701R1.001

Sample Description : LED

Item No./Part No. : Red High Power LED

Other(s)

Test Items	Unit	Test Method	MDL	Results
PFOS(Perfluorooctane Sulfonates-Acid/Metal Salt/Amide)	mg/kg	EPA 3550C & 8321B, LC/MS	1	N.D.

Picture of Sample as Received:



*** End ***

- NOTE:
- (1) N.D. = Not detected. (<MDL)
 - (2) mg/kg = ppm
 - (3) MDL = Method Detection Limit
 - (4) - = No regulation
 - (5) ** = Qualitative analysis (No Unit)
 - (6) Negative = Undetectable / Positive = Detectable

This document is issued by the Company subject to its General Conditions of Service posted on its website, available on request or accessible at www.sgs.com and www.sgs.com/sgsweb and, for electronic forest assessment, subject to Terms and Conditions for Electronic Declaration at www.sgs.com/sgsweb/declaration.htm. Attention is drawn to the limitation of liability, indemnification and jurisdiction clauses defined therein. Any holder of this document is advised that alteration rendered therein reflects the Company's findings in the line of its intervention only and within the limits of Client's instructions, if any. The Company's sole responsibility is to Client and this document does not constitute proof of a declaration from monitoring of the rights and obligations under the transaction documents. This document cannot be reproduced except in full, without prior written approval of the Company. Any unauthorized alteration, forgery or falsification of the content or appearance of this document is prohibited and offences may be prosecuted to the full extent of the law. Unless otherwise stated the results shown in this test report refer only to the sample(s) tested and such sample(s) are retained for 90 days only.

<h2>Revision History</h2> <p>(Model : SLHNNRO521N0S0Q0E3)</p>

Date	Revision History	Author	
		Drawn	Approved
2009.04.13	Initial Edition - Preliminary	S.H Lee	S.J Hong