

## IRS21844MPBF HALF-BRIDGE DRIVER

### Features

- Floating channel designed for bootstrap operation
- Fully operational to + 600 V
- Tolerant to negative transient voltage,  $dV/dt$  immune
- Gate drive supply range from 10 V to 20 V
- Undervoltage lockout for both channels
- 3.3 V and 5 V input logic compatible
- Matched propagation delay for both channels
- Logic and power ground +/- 5 V offset
- Lower  $di/dt$  gate driver for better noise immunity
- Output source/sink current capability 1.4 A/1.8 A
- Lead free, RoHS compliant

### Product Summary

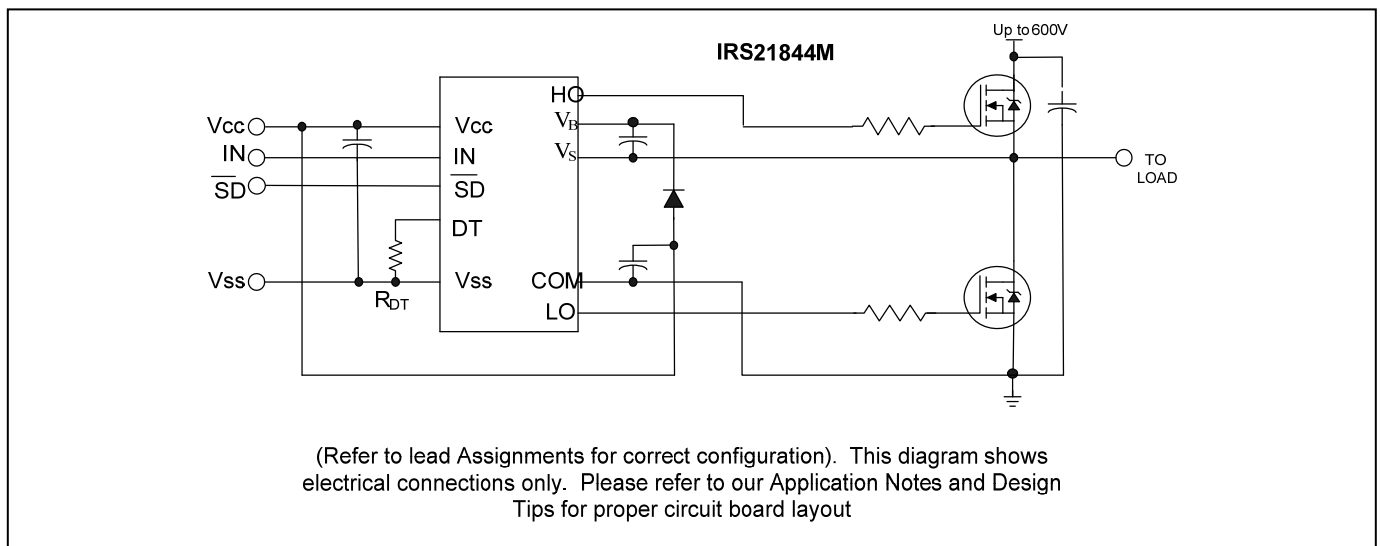
Topology	Half-Bridge
$V_{\text{OFFSET}}$	600 V
$V_{\text{OUT}}$	10 V – 20 V
$I_{\text{o+}}$ & $I_{\text{o-}}$ (typical)	1.9 A & 2.3 A
$t_{\text{on}}$ & $t_{\text{off}}$ (typical)	680 ns & 270 ns
Deadtime (typical)	400 ns ( $R_{\text{DT}} = 0 \Omega$ ) 5 $\mu\text{s}$ ( $R_{\text{DT}} = 200 \text{ k}\Omega$ )

### Package Options



MLPQ4x4 16- Leads  
(Without 2 leads)

### Typical Connection



## Description

The IRS21844MPBF is a high voltage, high speed power MOSFET and IGBT drivers with dependent high and low-side referenced output channels. Proprietary HVIC and latch immune CMOS technologies enable ruggedized monolithic construction. The logic input is compatible with standard CMOS or LSTTL output, down to 3.3 V logic. The output drivers feature a high pulse current buffer stage designed for minimum driver cross-conduction. The floating channel can be used to drive an N-channel power MOSFET or IGBT in the high-side configuration which operates up to 600 V.

## Feature Comparison: IRS2181(4)/IRS2183(4)/IRS2184(4)

Part	Input Logic	Cross-Conduction Prevention logic	Dead-Time	Ground Pins	Ton/Toff
2181	HIN/LIN	no	none	COM	180/220 ns
21814				V <sub>SS</sub> /COM	
2183	—	yes	Internal 500ns	COM	180/220 ns
21834	HIN/LIN		Programmable 0.4 – 5 us	V <sub>SS</sub> /COM	
2184	—	yes	Internal 500ns	COM	680/270 ns
21844	IN/SD		Programmable 0.4 – 5 us	V <sub>SS</sub> /COM	

## Qualification Information<sup>†</sup>

<b>Qualification Level</b>		Industrial <sup>††</sup> (per JEDEC JESD 47)	
		Comments: This IC has passed JEDEC's Industrial qualification. IR's Consumer qualification level is granted by extension of the higher Industrial level.	
<b>Moisture Sensitivity Level</b>		MLPQ4x4 14L	MSL2 <sup>†††</sup> (per IPC/JEDEC J-STD-020)
<b>ESD</b>	Machine Model	Class A (+/-100V) (per JEDEC standard JESD22-A115)	
	Human Body Model	Class 1C (+/-1500V) (per EIA/JEDEC standard EIA/JESD22-A114)	
	Charged Device Model	Class III (+/-1000V) (per JEDEC standard JESD22-C101)	
<b>IC Latch-Up Test</b>		Class II, Level A (per JESD78A)	
<b>RoHS Compliant</b>		Yes	

† Qualification standards can be found at International Rectifier's web site <http://www.irf.com/>

†† Higher qualification ratings may be available should the user have such requirements. Please contact your International Rectifier sales representative for further information.

††† Higher MSL ratings may be available for the specific package types listed here. Please contact your International Rectifier sales representative for further information.

### Absolute Maximum Ratings

Absolute Maximum Ratings indicate sustained limits beyond which damage to the device may occur. All voltage parameters are absolute voltages referenced to COM. The thermal resistance and power dissipation ratings are measured under board mounted and still air conditions.

Symbol	Definition	Min	Max	Units
$V_B$	High-side floating absolute voltage	-0.3	620	V
$V_S$	High-side floating supply offset voltage	$V_B - 25$	$V_B + 0.3$	
$V_{HO}$	High-side floating output voltage	$V_S - 0.3$	$V_B + 0.3$	
$V_{CC}$	Low-side and logic fixed supply voltage	-0.3	20 <sup>†</sup>	
$V_{LO}$	Low-side output voltage	-0.3	$V_{CC} + 0.3$	
DT	Programmable deadtime pin voltage	$V_{SS} - 0.3$	$V_{CC} + 0.3$	
$V_{IN}$	Logic input voltage (IN & $\overline{SD}$ )	$V_{SS} - 0.3$	$V_{CC} + 0.3$	
$V_{SS}$	Logic ground	$V_{CC} - 20$	$V_{CC} + 0.3$	
$dV_S/dt$	Allowable offset supply voltage transient	—	50	
$P_D$	Package power dissipation @ $T_A \leq 25^\circ\text{C}$	—	2.08	W
$R_{thJA}$	Thermal resistance, junction to ambient	—	36	$^\circ\text{C}/\text{W}$
$T_J$	Junction temperature	—	150	$^\circ\text{C}$
$T_S$	Storage temperature	-50	150	
$T_L$	Lead temperature (soldering, 10 seconds)	—	300	

† All supplies are fully tested at 25 V and an internal 20 V clamp exists for each supply.

### Recommended Operating Conditions

The input/output logic timing diagram is shown in Figure 1. For proper operation the device should be used within the recommended conditions. The  $V_S$  and  $V_{SS}$  offset rating are tested with all supplies biased at a 15 V differential.

Symbol	Definition	Min	Max	Units
$V_B$	High-side floating supply absolute voltage	$V_S + 10$	$V_S + 20$	V
$V_S$	High-side floating supply offset voltage	(††)	600	
$V_{HO}$	High-side floating output voltage	$V_S$	$V_B$	
$V_{CC}$	Low-side and logic fixed supply voltage	10	20	
$V_{LO}$	Low-side output voltage	0	$V_{CC}$	
$V_{IN}$	Logic input voltage (IN & $\overline{SD}$ ) (†††)	$V_{SS}$	$V_{CC}$	
DT	Programmable deadtime pin voltage	$V_{SS}$	$V_{CC}$	
$V_{SS}$	Logic ground	-5	5	
$T_A$	Ambient temperature	-40	125	$^\circ\text{C}$

†† Logic operational for  $V_S$  of -5 V to +600 V. Logic state held for  $V_S$  of -5 V to  $-V_{BS}$ . (Please refer to Design Tip DT97-3 for more details).

††† HIN and LIN are internally clamped with a 5.2 V zener diode.

### Dynamic Electrical Characteristics

$V_{BIAS}$  ( $V_{CC}$ ,  $V_{BS}$ ) = 15 V,  $V_{SS}$  = COM,  $C_L$  = 1000 pF,  $T_A$  = 25°C,  $DT = V_{SS}$  unless otherwise specified.

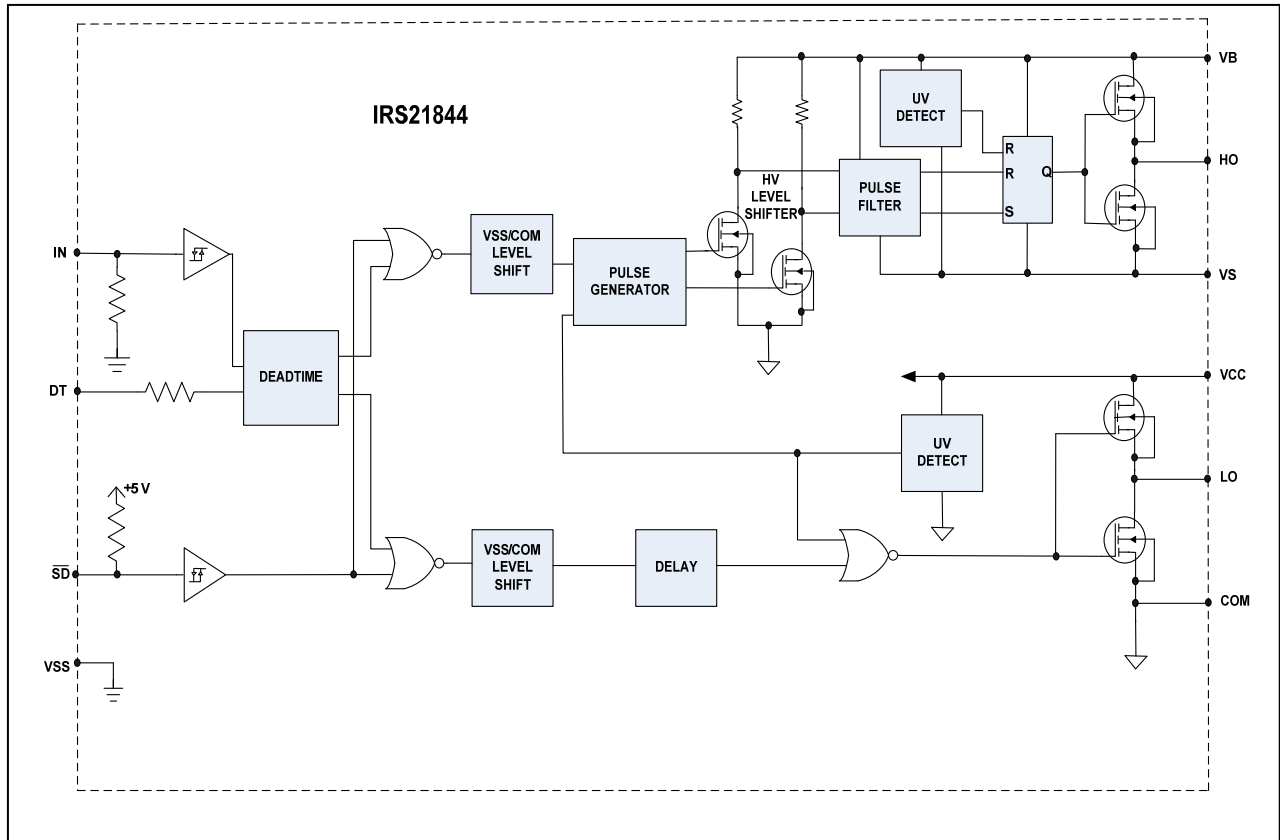
Symbol	Definition	Min	Typ	Max	Units	Test Conditions
$t_{on}$	Turn-on propagation delay	—	680	900	ns	$V_S = 0$ V
$t_{off}$	Turn-off propagation delay	—	270	400		$V_S = 0$ V or 600 V
$t_{sd}$	Shut-down propagation delay	—	180	270		
$MT_{on}$	Delay matching, HS & LS turn-on	—	0	90		
$MT_{off}$	Delay matching, HS & LS turn-off	—	0	40		
$t_r$	Turn-on rise time	—	40	60		$V_S = 0$ V
$t_f$	Turn-off fall time	—	20	35		
DT	Deadtime: LO turn-off to HO turn-on ( $DT_{LO-HO}$ ) & HO turn-off to LO turn-on ( $DT_{HO-LO}$ )	280	400	520	$\mu$ s	$R_{DT} = 0$ $\Omega$
		4	5	6		$R_{DT} = 200$ k $\Omega$
MDT	Deadtime matching $DT_{LO-HO} - DT_{HO-LO}$	—	0	50	ns	$R_{DT} = 0$ $\Omega$
		—	0	600		$R_{DT} = 200$ k $\Omega$

### Static Electrical Characteristics

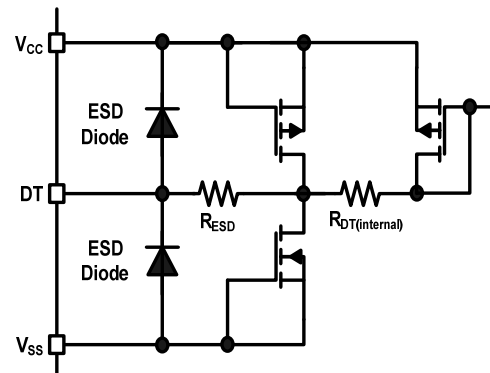
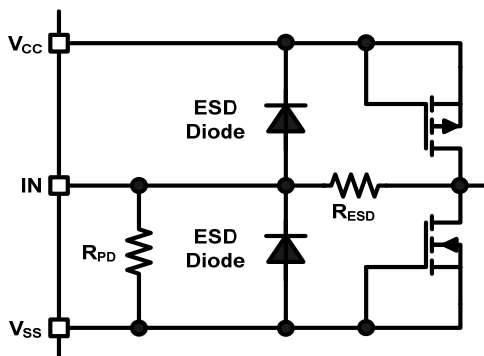
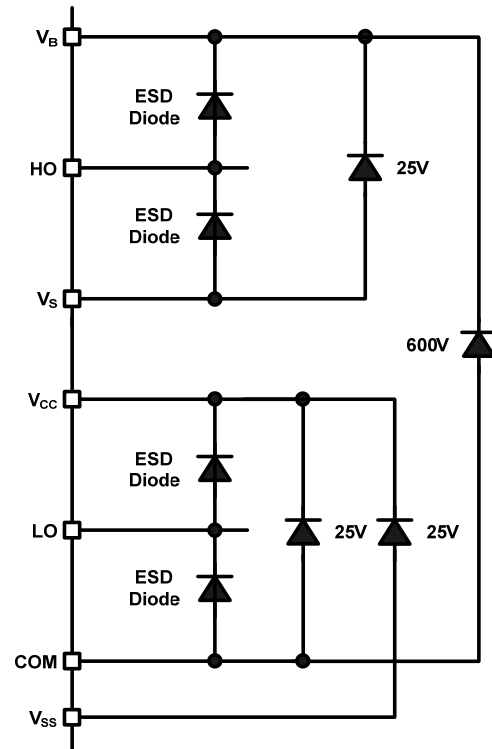
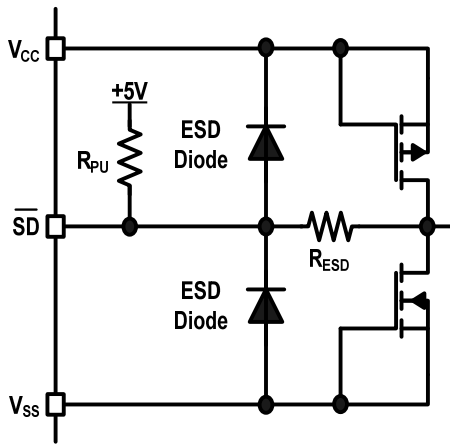
$V_{BIAS}$  ( $V_{CC}$ ,  $V_{BS}$ ) = 15 V,  $V_{SS}$  = COM,  $DT = V_{SS}$  and  $T_A = 25^\circ\text{C}$  unless otherwise specified. The  $V_{IL}$ ,  $V_{IH}$  and  $I_{IN}$  parameters are referenced to  $V_{SS}/\text{COM}$  and are applicable to the respective input leads: IN and  $\overline{SD}$ . The  $V_O$ ,  $I_O$  and  $R_{on}$  parameters are referenced to COM and are applicable to the respective output leads: HO and LO.

Symbol	Definition	Min	Typ	Max	Units	Test Conditions
$V_{IH}$	Logic "1" input voltage for HO & logic "0" for LO	2.5	—	—	V	$V_{CC} = 10$ V to 20 V
$V_{IL}$	Logic "0" input voltage for HO & logic "1" for LO	—	—	0.8		
$V_{SD,TH+}$	$\overline{SD}$ input positive going threshold	2.5	—	—		
$V_{SD,TH-}$	$\overline{SD}$ input negative going threshold	—	—	0.8		
$V_{OH}$	High level output voltage, $V_{BIAS} - V_O$	—	—	1.4		
$V_{OL}$	Low level output voltage, $V_O$	—	—	0.2		$I_O = 20$ mA
$I_{LK}$	Offset supply leakage current	—	—	50	$\mu$ A	$V_B = V_S = 600$ V
$I_{QBS}$	Quiescent $V_{BS}$ supply current	20	60	150		$V_{IN} = 0$ V or 5 V
$I_{QCC}$	Quiescent $V_{CC}$ supply current	0.4	1.0	1.6	mA	
$I_{IN+}$	Logic "1" input bias current	—	25	60	$\mu$ A	$IN = 5$ V, $\overline{SD} = 0$ V
$I_{IN-}$	Logic "0" input bias current	—	—	5.0		$IN = 0$ V, $\overline{SD} = 5$ V
$V_{CCUV+}$ $V_{BSUV+}$	$V_{CC}$ and $V_{BS}$ supply undervoltage positive going threshold	8.0	8.9	9.8	V	
$V_{CCUV-}$ $V_{BSUV-}$	$V_{CC}$ and $V_{BS}$ supply undervoltage negative going threshold	7.4	8.2	9.0		
$V_{CCUVH}$ $V_{BSUVH}$	Hysteresis	0.3	0.7	—		
$I_{O+}$	Output high short circuit pulsed current	1.4	1.9	—	A	$V_O = 0$ V, $PW \leq 10$ $\mu$ s
$I_{O-}$	Output low short circuit pulsed current	1.8	2.3	—		$V_O = 15$ V, $PW \leq 10$ $\mu$ s

**Functional Block Diagram: IRS21844**



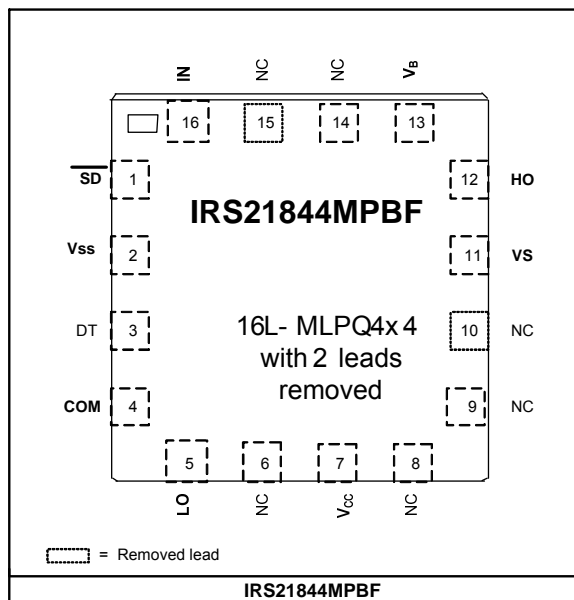
**Input/Output Pin Equivalent Circuit Diagrams: IRS21844**



**Lead Definitions**

PIN	Symbol	Description
1	$\overline{SD}$	Logic input for shutdown (referenced to $V_{SS}$ )
2	$V_{SS}$	Logic ground
3	DT	Programmable deadtime lead, referenced to $V_{SS}$
4	COM	Low-side return
5	LO	Low-side gate drive output
6	NC	No Connection
7	$V_{CC}$	Low-side and logic fixed supply
8	NC	No Connection
9	NC	No Connection
10	NC	No Connection (removed lead)
11	$V_S$	High-side floating supply return
12	HO	High-side gate drive output
13	$V_B$	High-side floating supply
14	NC	No Connection
15	NC	No Connection (removed lead)
16	IN	Logic input for high-side gate driver output (HO), in phase

**Lead Assignments: IRS21844**



### Application Information and Additional Details

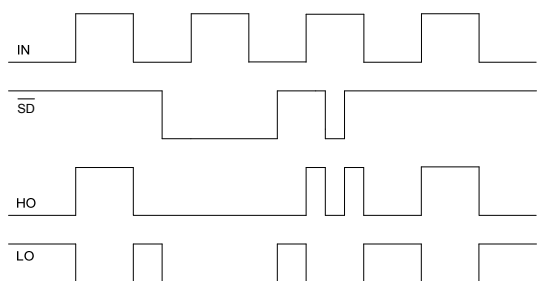


Figure 1: Input/Output Timing Diagram

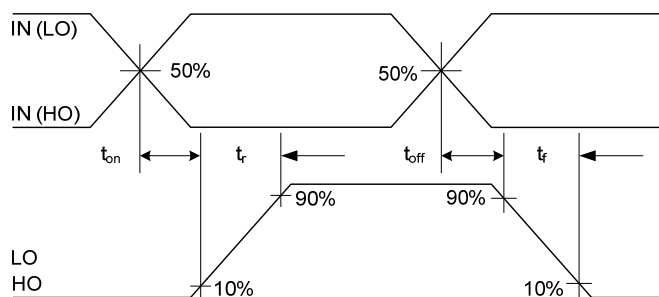


Figure 2: Switching Time Waveform Definitions

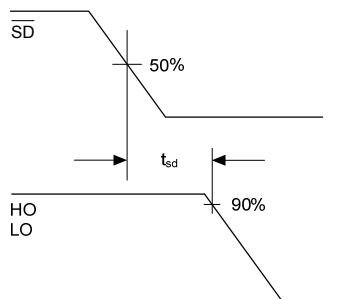


Figure 3: Shutdown Waveform Definitions

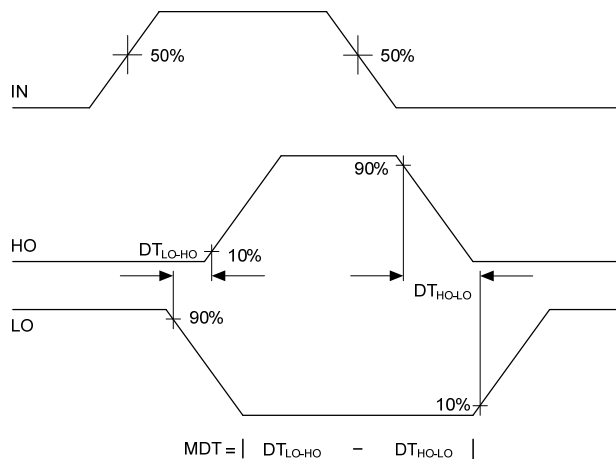


Figure 4: Deadtime Waveform Definitions

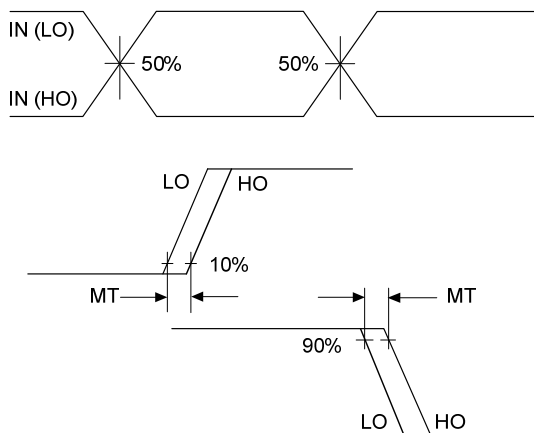
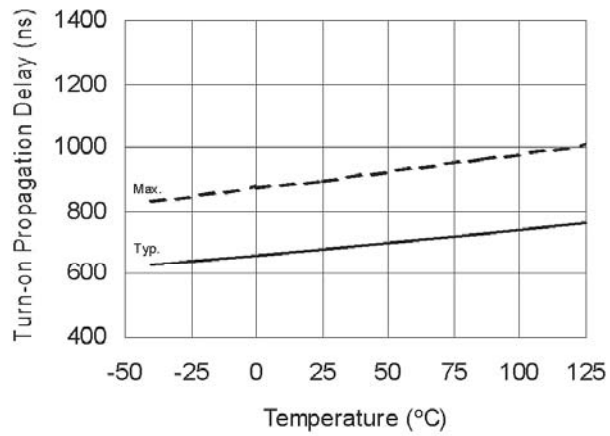
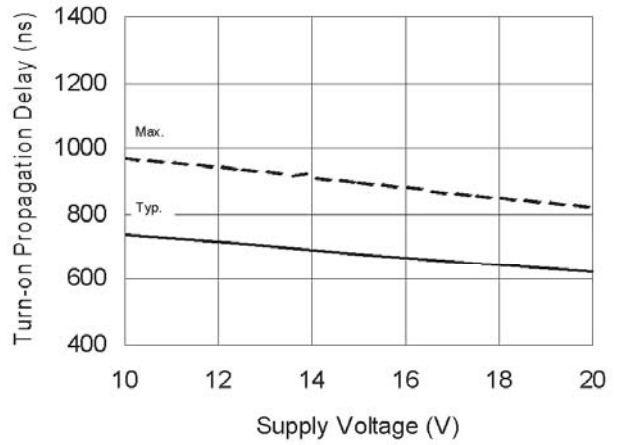


Figure 5: Delay Matching Waveform Definitions

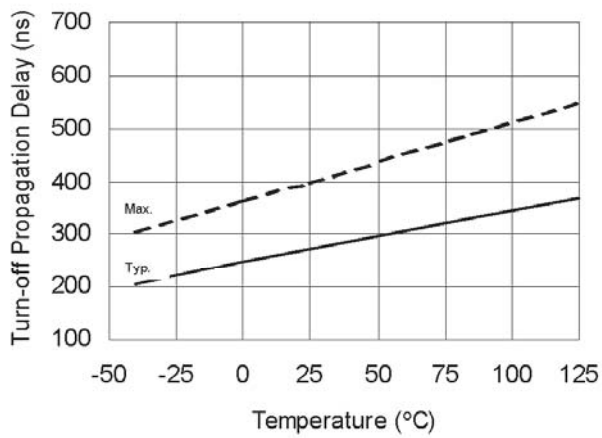




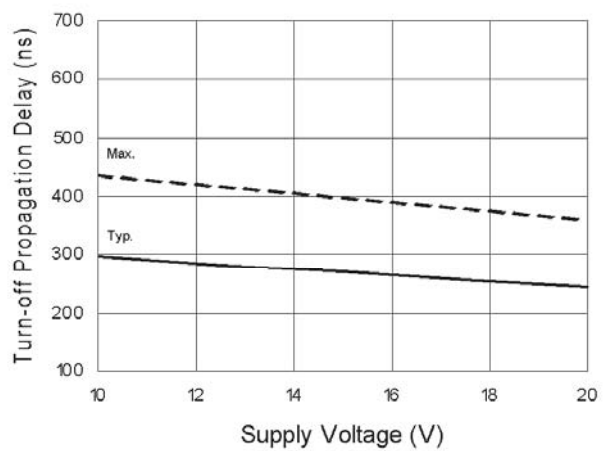
**Figure 6A. Turn-On Propagation Delay vs. Temperature**



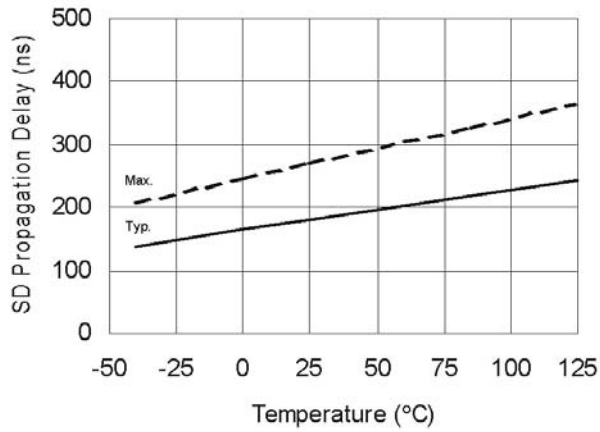
**Figure 6B. Turn-On Propagation Delay vs. Supply Voltage**



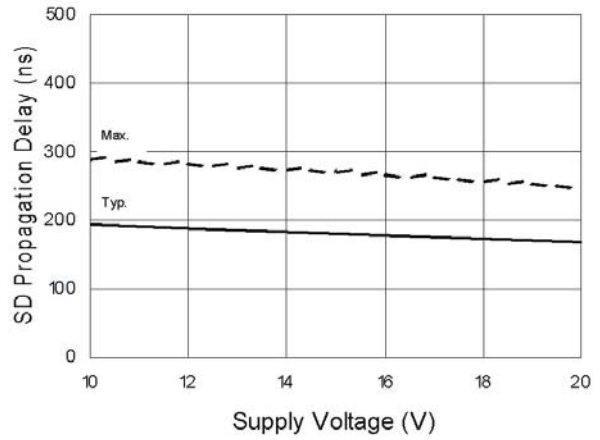
**Figure 7A. Turn-Off Propagation Delay vs. Temperature**



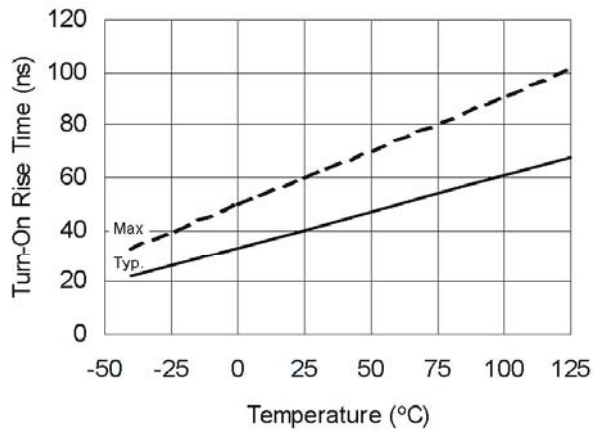
**Figure 7B. Turn-Off Propagation Delay vs. Supply Voltage**



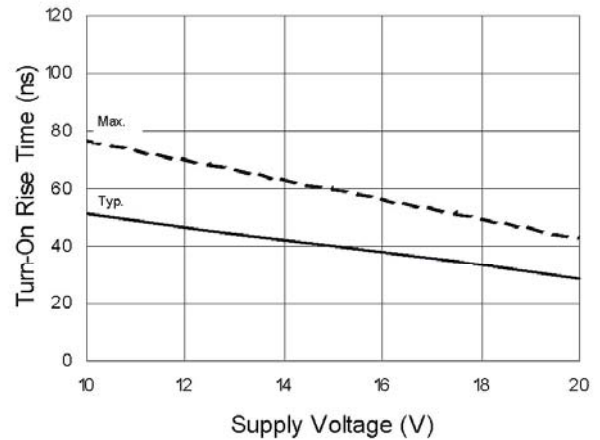
**Figure 8A. SD Propagation Delay vs. Temperature**



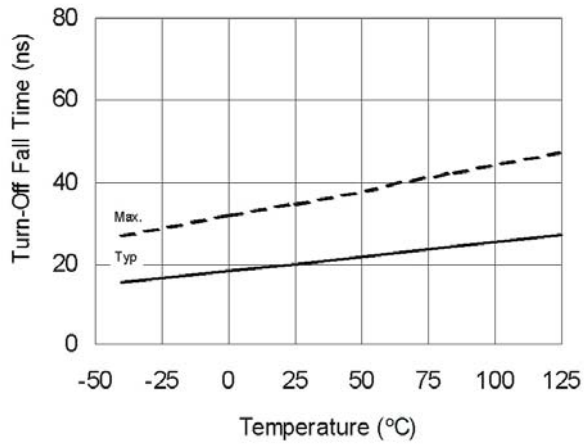
**Figure 8B. SD Propagation Delay vs. Supply Voltage**



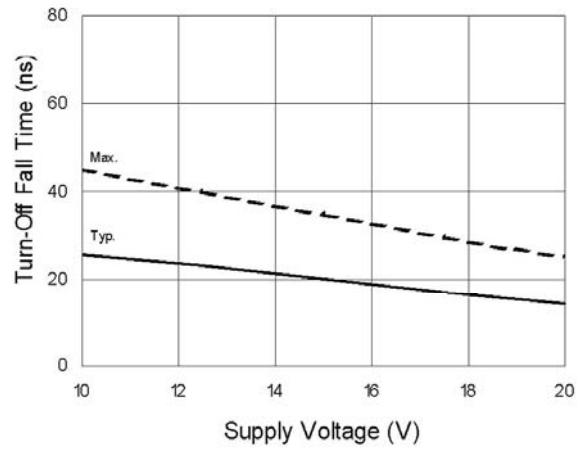
**Figure 9A. Turn-On Rise Time vs. Temperature**



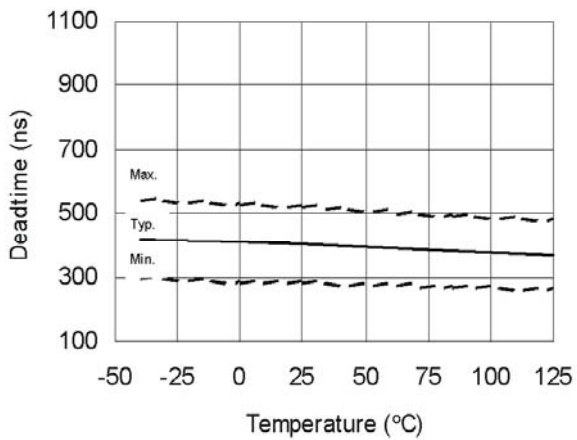
**Figure 9B. Turn-On Rise Time vs. Supply Voltage**



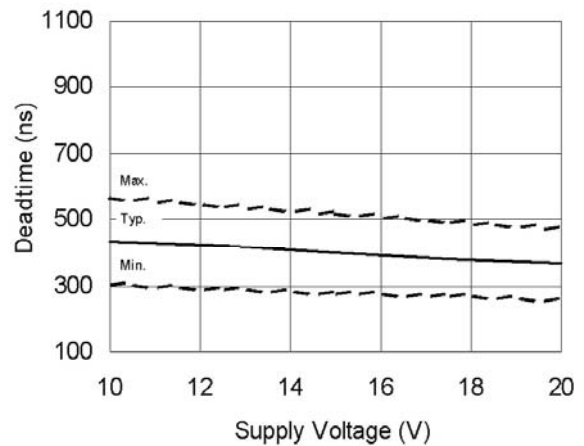
**Figure 10A. Turn-Off Fall Time vs. Temperature**



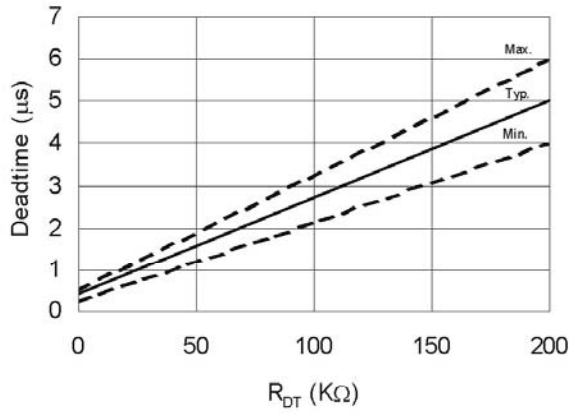
**Figure 10B. Turn-Off Fall Time vs. Supply Voltage**



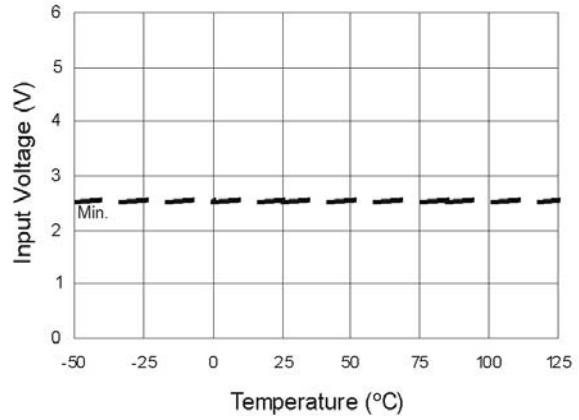
**Figure 11A. Deadtime vs. Temperature**



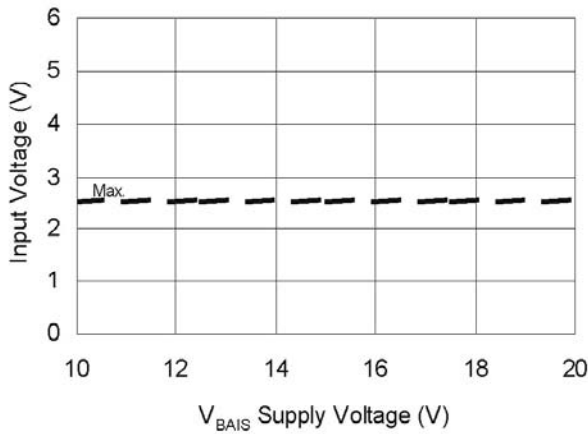
**Figure 11B. Deadtime vs. Supply Voltage**



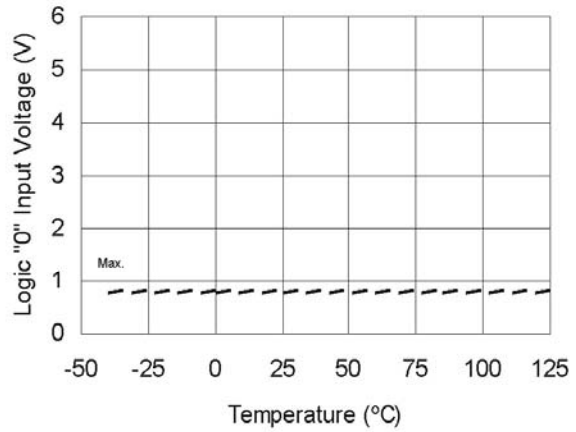
**Figure 11C. Deadtime vs.  $R_{DT}$**



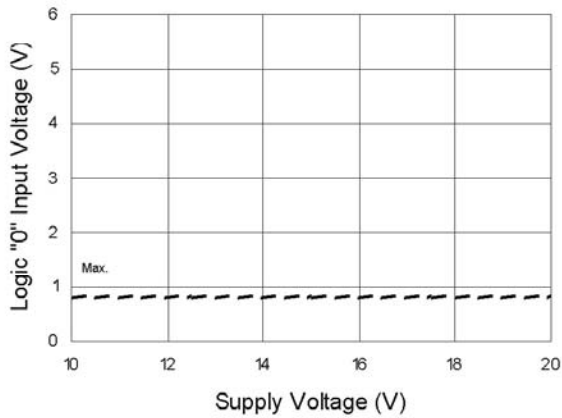
**Figure 12A. Logic "1" Input Voltage vs. Temperature**



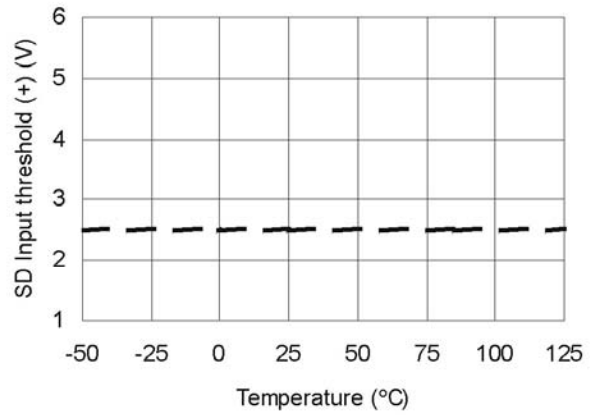
**Figure 12B. Logic "1" Input Voltage vs. Supply Voltage**



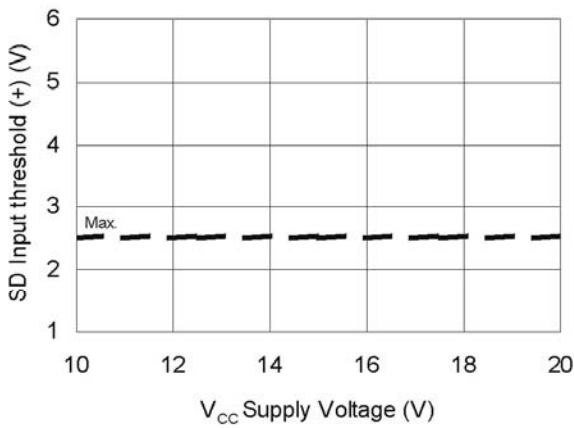
**Figure 13A. Logic "0" Input Voltage vs. Temperature**



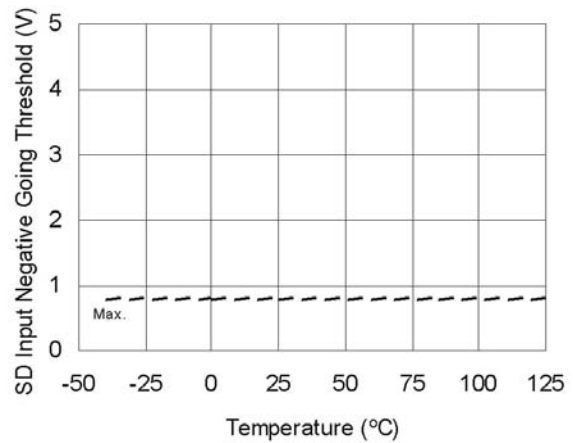
**Figure 13B. Logic "0" Input Voltage vs. Supply Voltage**



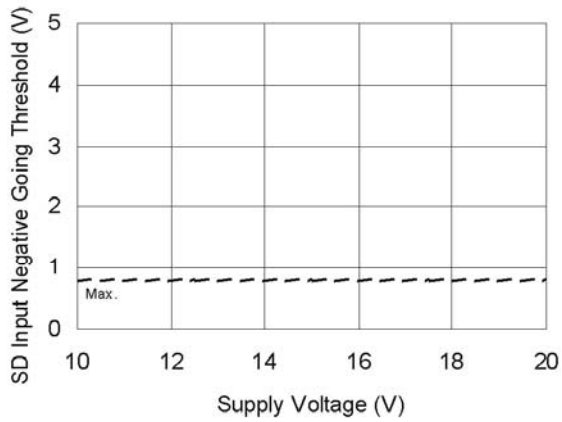
**Figure 14A. SD input positive going threshold (+) vs. Temperature**



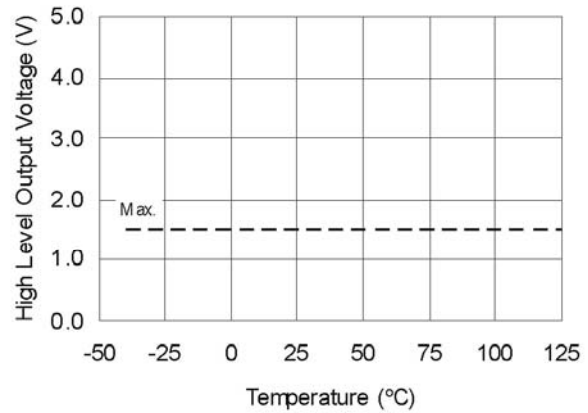
**Figure 14B. SD input positive going threshold (+) vs. Supply Voltage**



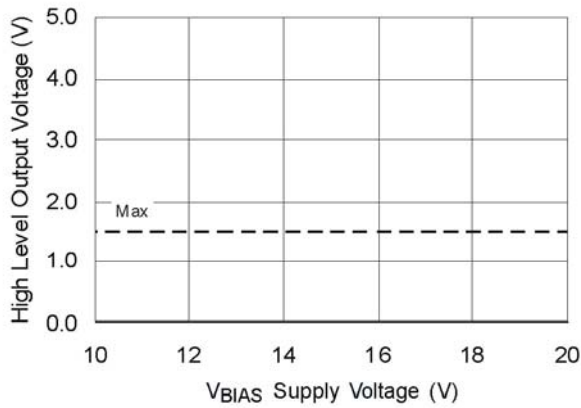
**Figure 15A. SD Input Negative Going Threshold vs. Temperature**



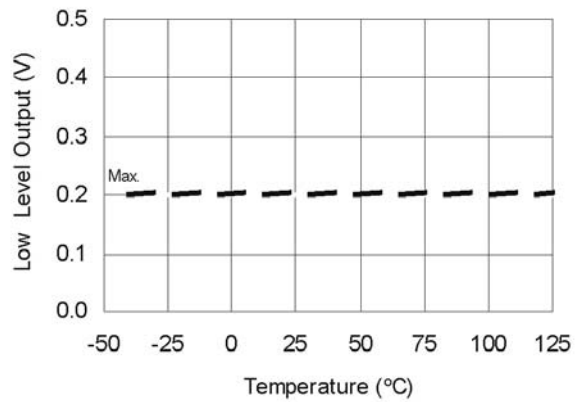
**Figure 15B. SD Input Negative Going Threshold vs. Supply Voltage**



**Figure 16A. High Level Output Voltage vs. Temperature (I<sub>O</sub> = 0 mA)**



**Figure 16B. High Level Output Voltage vs. Supply Voltage (I<sub>O</sub> = 0 mA)**



**Figure 17A. Low Level Output vs. Temperature**

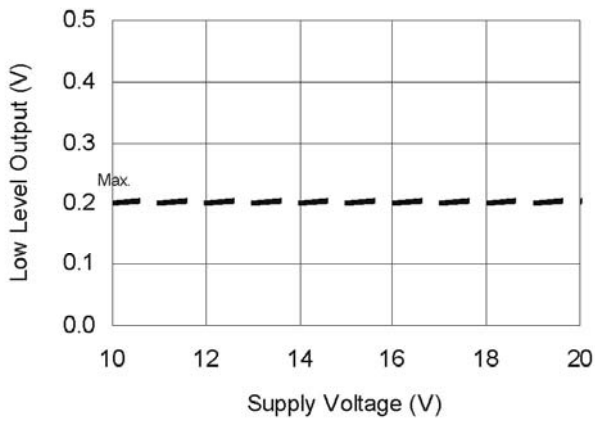


Figure 17B. Low Level Output vs. Supply Voltage

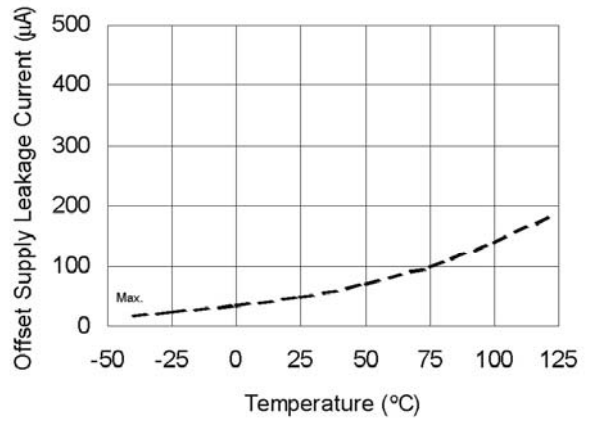


Figure 18A. Offset Supply Leakage Current vs. Temperature

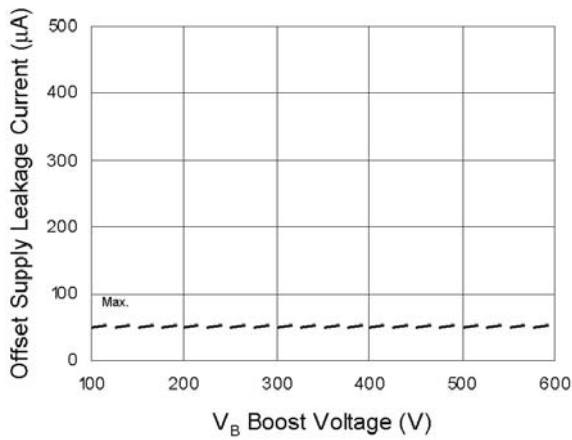


Figure 18B. Offset Supply Leakage Current vs. V<sub>B</sub> Boost Voltage

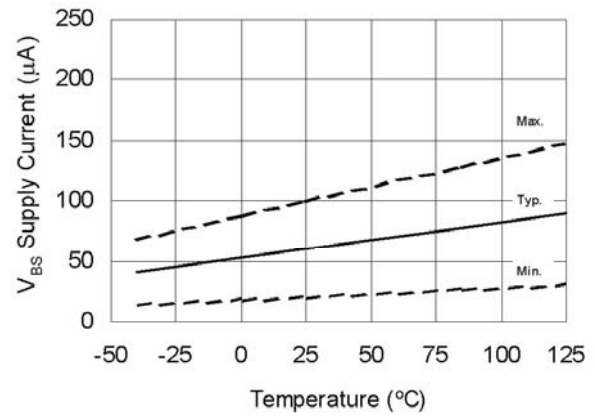
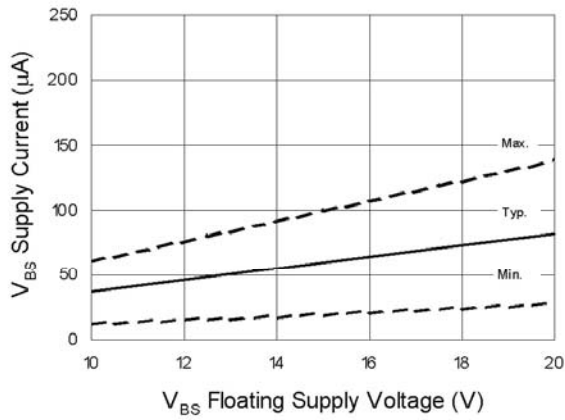
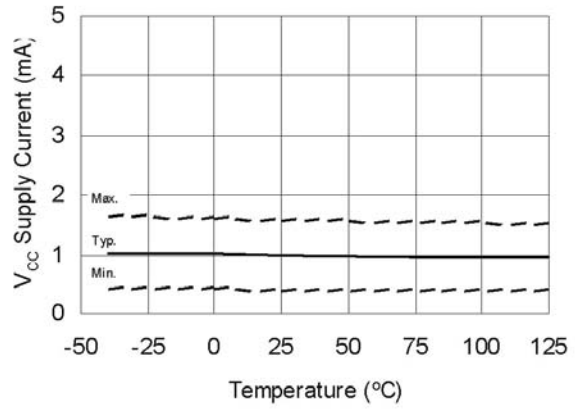


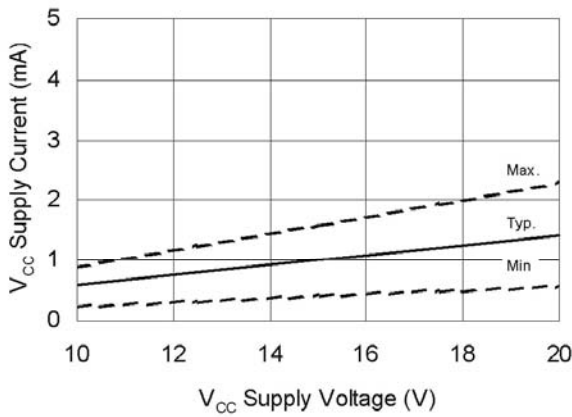
Figure 19A. V<sub>BS</sub> Supply Current vs. Temperature



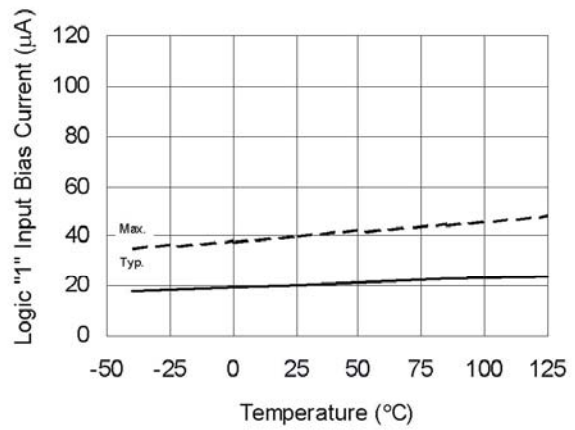
**Figure 19B. V<sub>BS</sub> Supply Current vs. V<sub>BS</sub> Floating Supply Voltage**



**Figure 20A. V<sub>CC</sub> Supply Current vs. Temperature**



**Figure 20B. V<sub>CC</sub> Supply Current vs. V<sub>CC</sub> Supply Voltage**



**Figure 21A. Logic "1" Input Bias Current vs. Temperature**



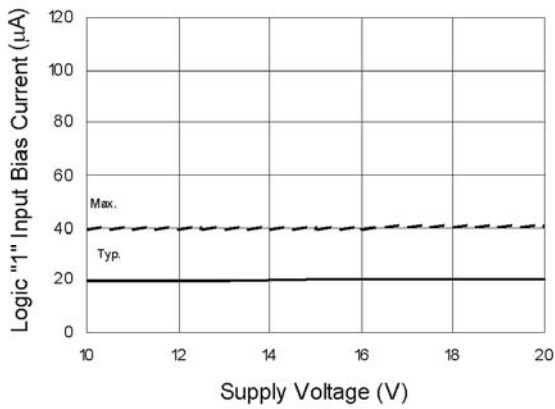


Figure 21B. Logic "1" Input Bias Current vs. Supply Voltage

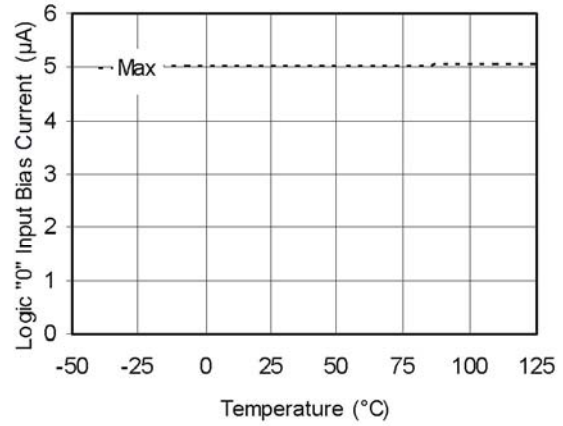


Figure 22A. Logic "0" Input Bias Current vs. Temperature

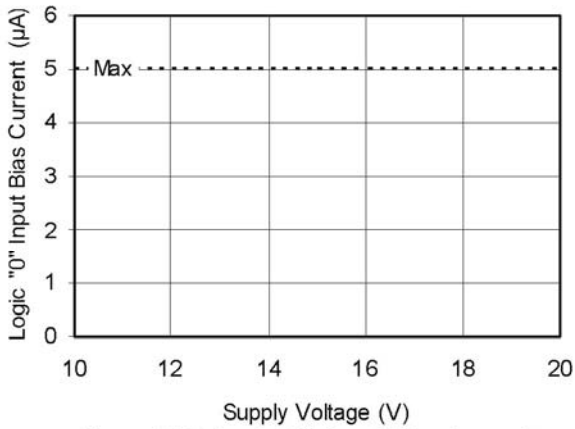


Figure 22B. Logic "0" Input Bias Current vs. Voltage

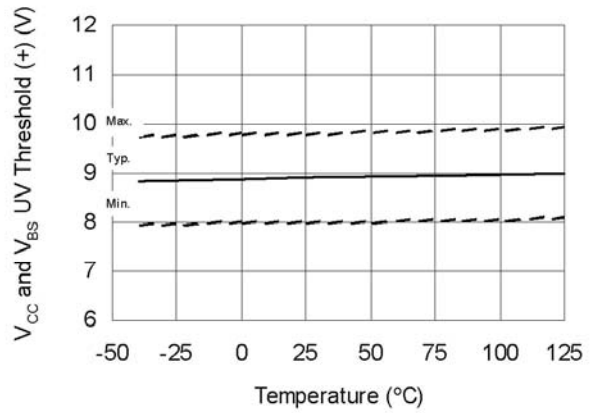
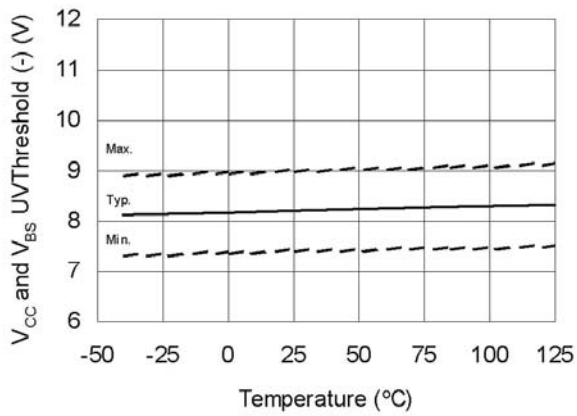
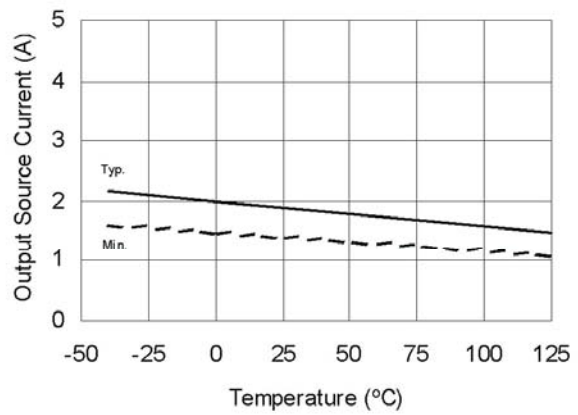


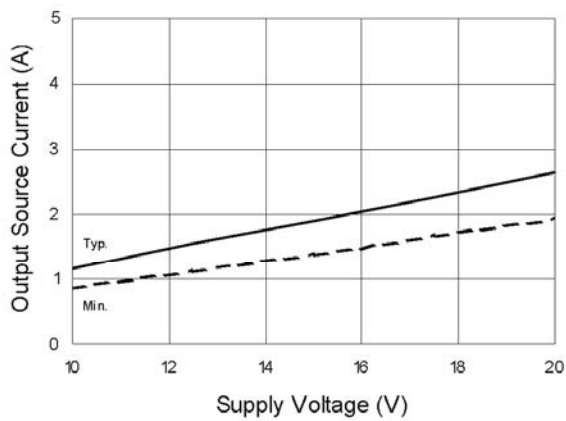
Figure 23. V<sub>CC</sub> and V<sub>BS</sub> Undervoltage Threshold (+) vs. Temperature



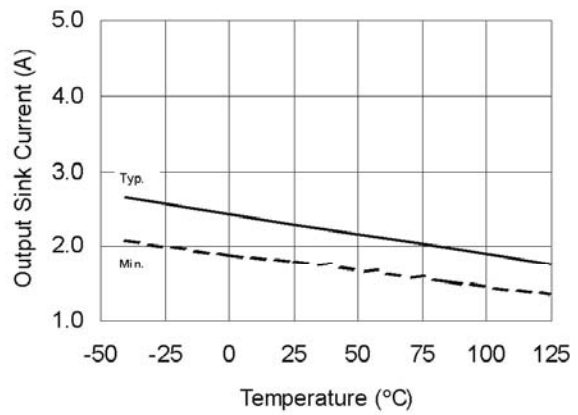
**Figure 24.  $V_{CC}$  and  $V_{BS}$  Undervoltage Threshold (-) vs. Temperature**



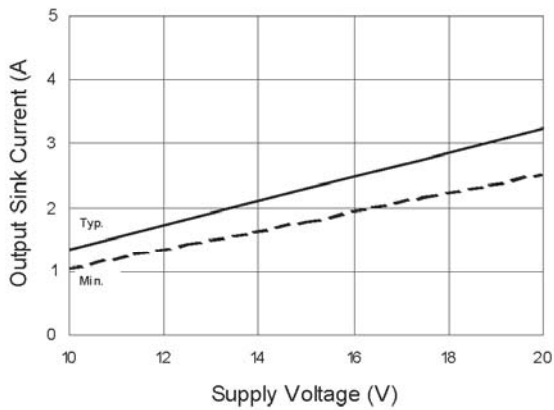
**Figure 25A. Output Source Current vs. Temperature**



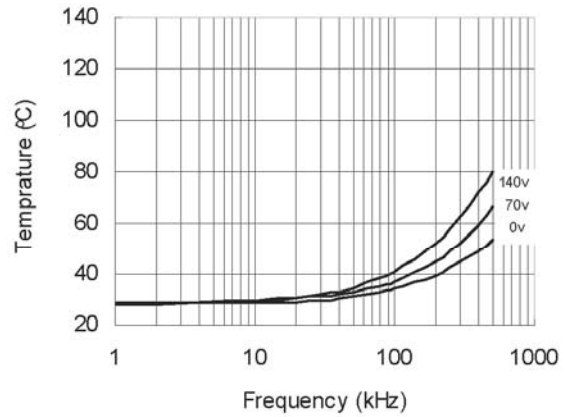
**Figure 25B. Output Source Current vs. Supply Voltage**



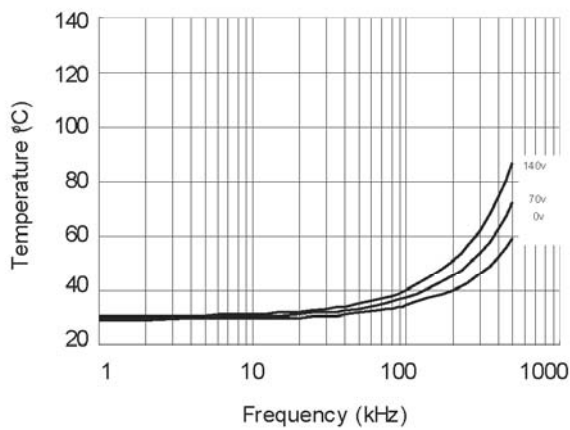
**Figure 26A. Output Sink Current vs. Temperature**



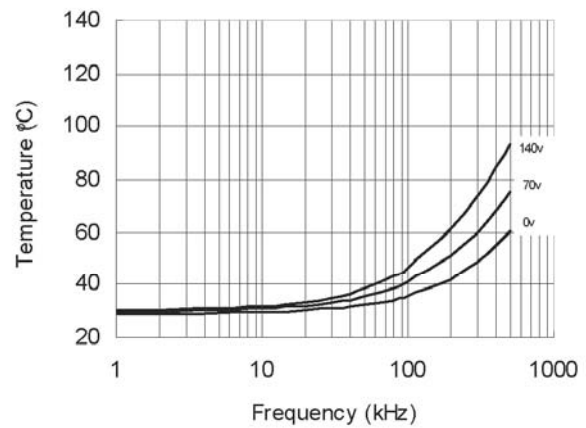
**Figure 26B. Output Sink Current vs. Supply Voltage**



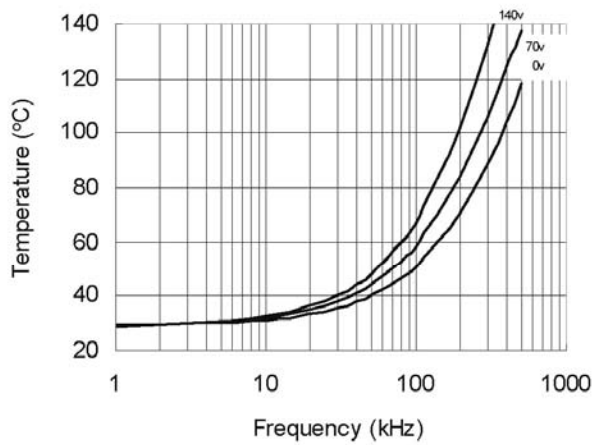
**Figure 27. IRS2181 vs. Frequency (IRFBC20),  $R_{gate}=33 \Omega$ ,  $V_{CC}=15 V$**



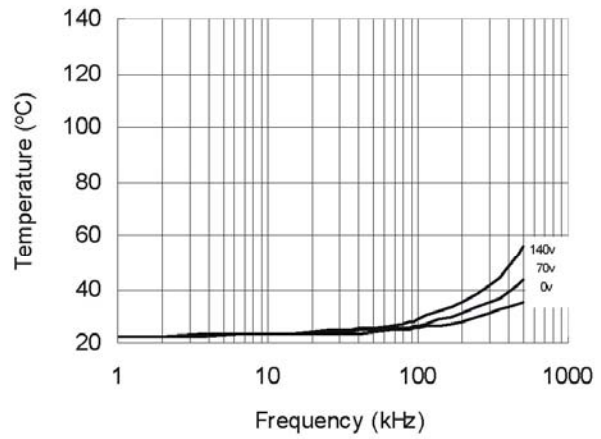
**Figure 28. IRS2181 vs. Frequency (IRFBC30),  $R_{gate}=22 \Omega$ ,  $V_{CC}=15 V$**



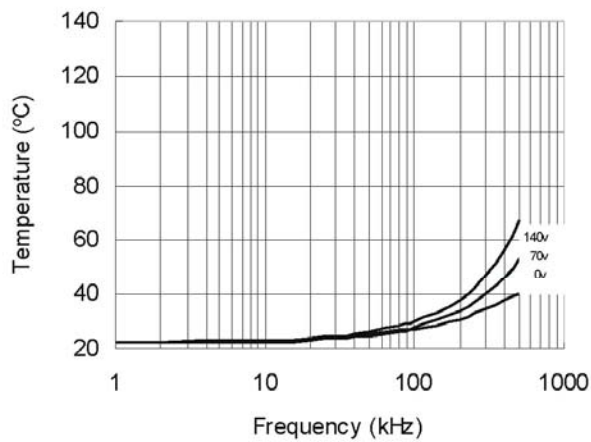
**Figure 29. IRS2181 vs. Frequency (IRFBC40),  $R_{gate}=15 \Omega$ ,  $V_{CC}=15 V$**



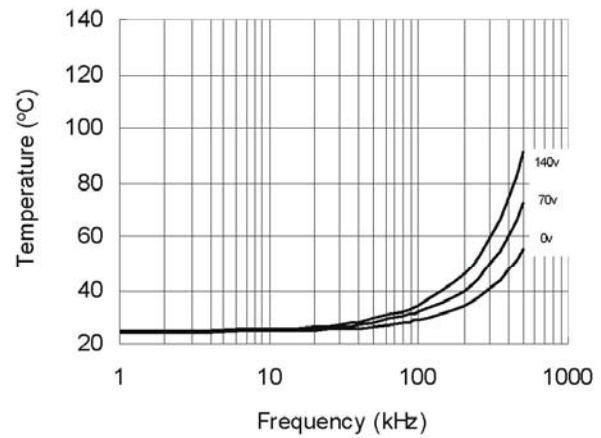
**Figure 30. IRS2181 vs. Frequency (IRFPE50),  
 $R_{gate}=10 \Omega, V_{CC}=15 V$**



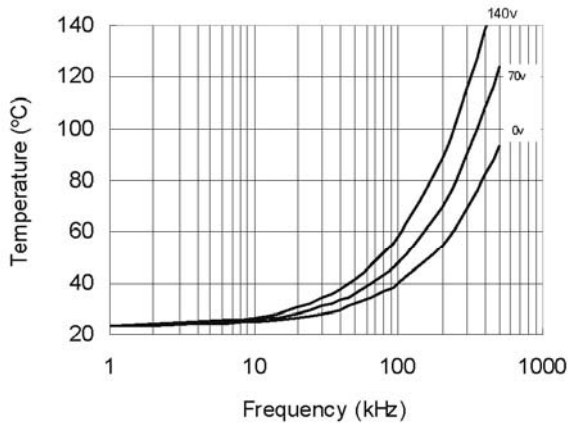
**Figure 31. IRS21814 vs. Frequency (IRFBC20),  
 $R_{gate}=33 \Omega, V_{CC}=15 V$**



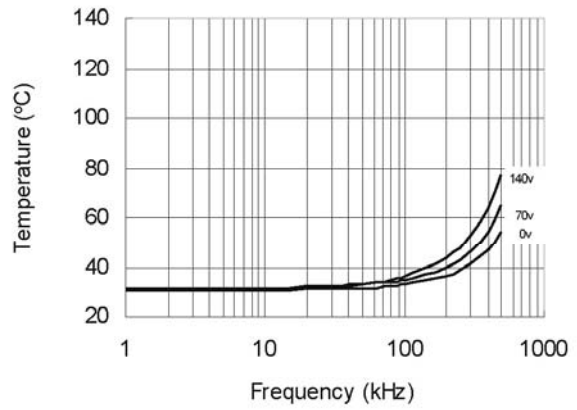
**Figure 32. IRS21814 vs. Frequency (IRFBC30),  
 $R_{gate}=22 \Omega, V_{CC}=15 V$**



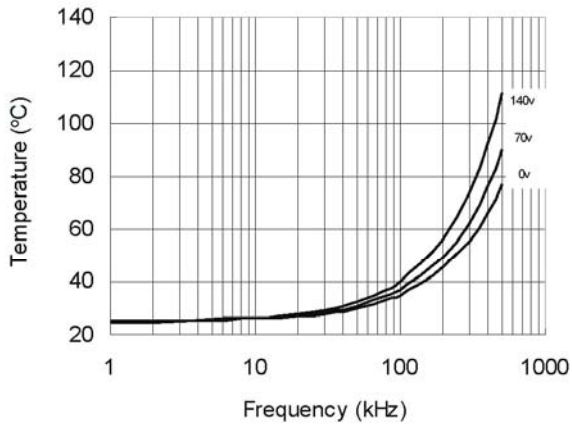
**Figure 33. IRS21814 vs. Frequency (IRFBC40),  
 $R_{gate}=15 \Omega, V_{CC}=15 V$**



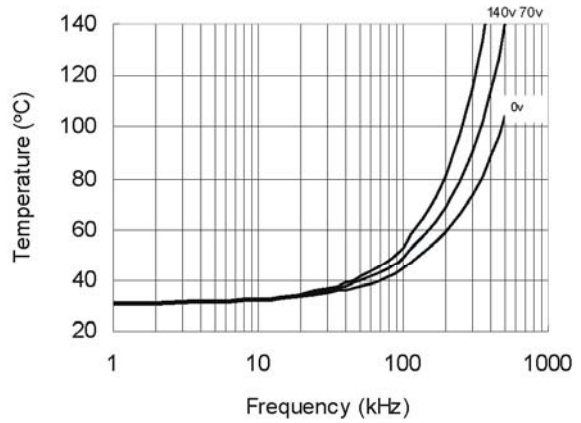
**Figure 34. IRS21814 vs. Frequency (IRFPE50),  
 $R_{gate}=10 \Omega, V_{CC}=15 V$**



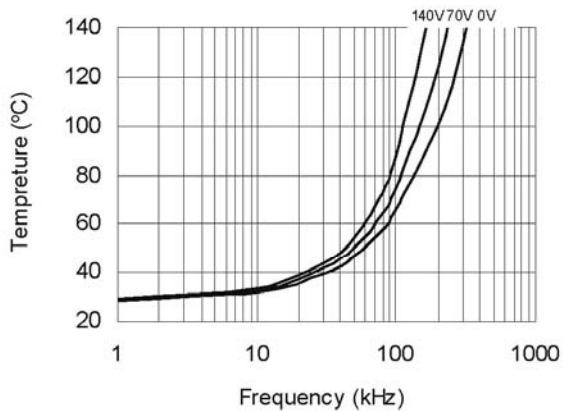
**Figure 35. IRS2181s vs. Frequency (IRFBC20),  
 $R_{gate}=33 \Omega, V_{CC}=15 V$**



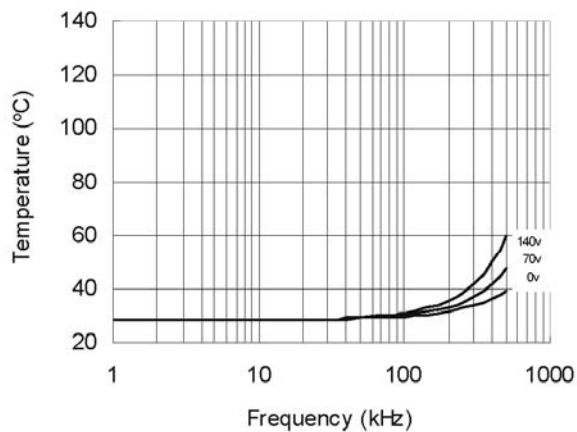
**Figure 36. IRS2181s vs. Frequency (IRFBC30),  
 $R_{gate}=22 \Omega, V_{CC}=15 V$**



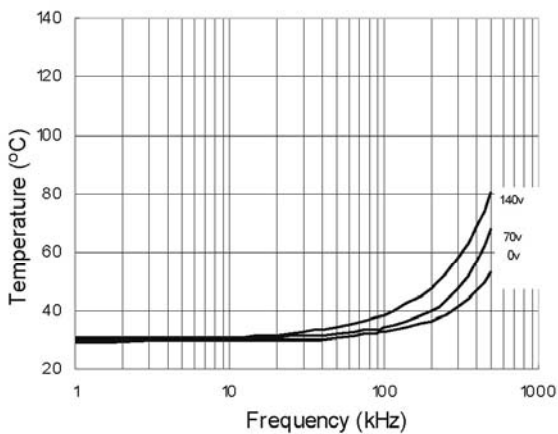
**Figure 37. IRS2181s vs. Frequency (IRFBC40),  
 $R_{gate}=15 \Omega, V_{CC}=15 V$**



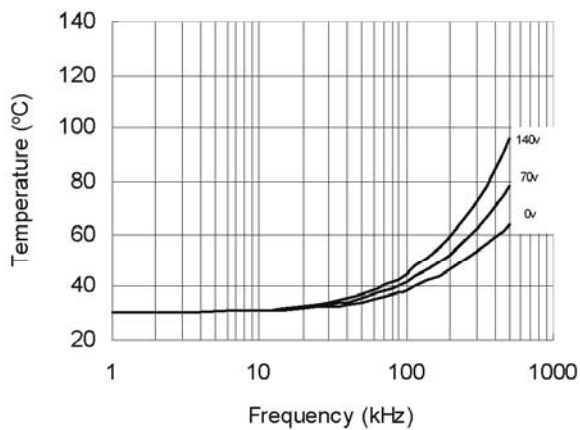
**Figure 38. IRS2181s vs. Frequency (IRFPE50),  
 $R_{gate}=10 \Omega, V_{CC}=15 V$**



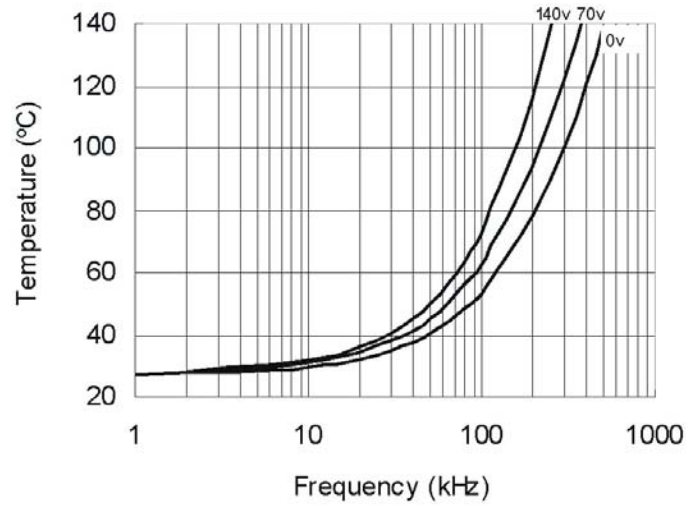
**Figure 39. IRS21814s vs. Frequency (IRFBC20),  
 $R_{gate}=33 \Omega, V_{CC}=15 V$**



**Figure 40. IRS21814s vs. Frequency (IRFBC30),  
 $R_{gate}=22 \Omega, V_{CC}=15 V$**

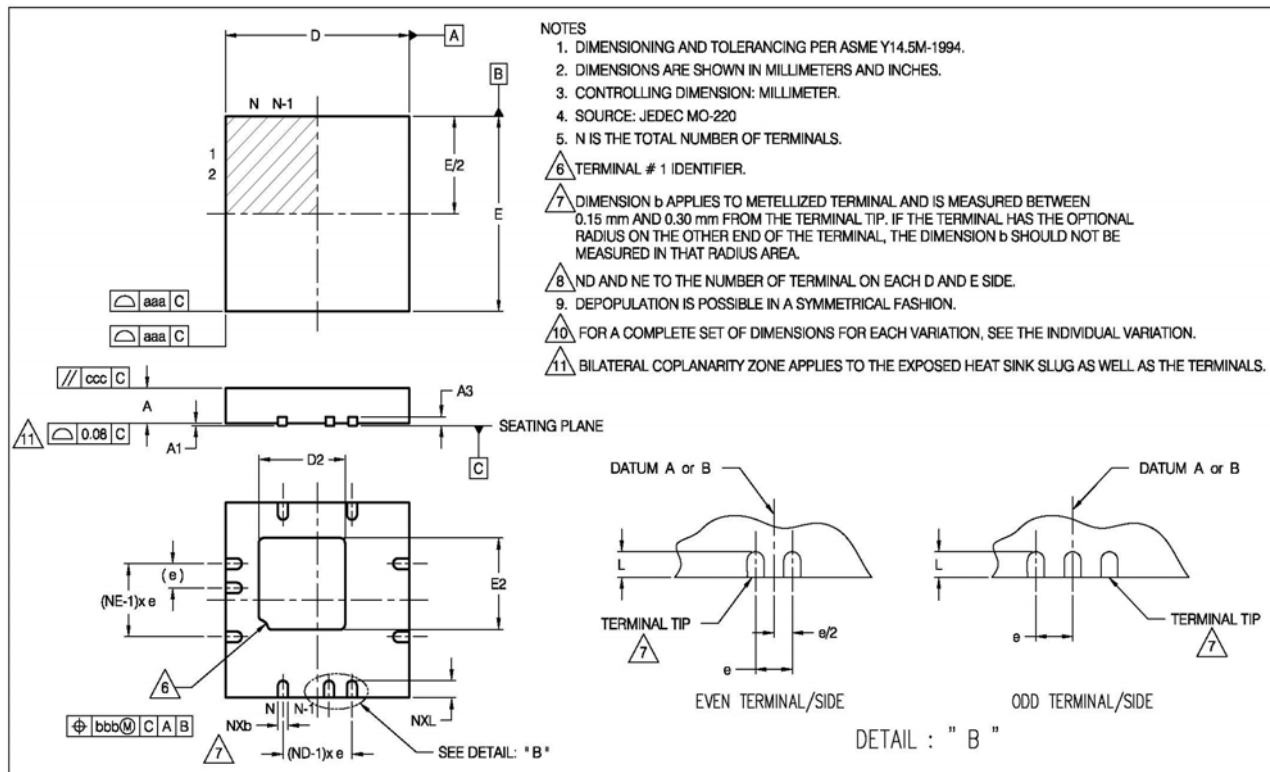


**Figure 41. IRS21814s vs. Frequency (IRFBC40),  
 $R_{gate}=15 \Omega, V_{CC}=15 V$**



**Figure 42. IRS21814s vs. Frequency (IRFPE50),  
 $R_{gate}=10 \Omega, V_{CC}=15 V$**

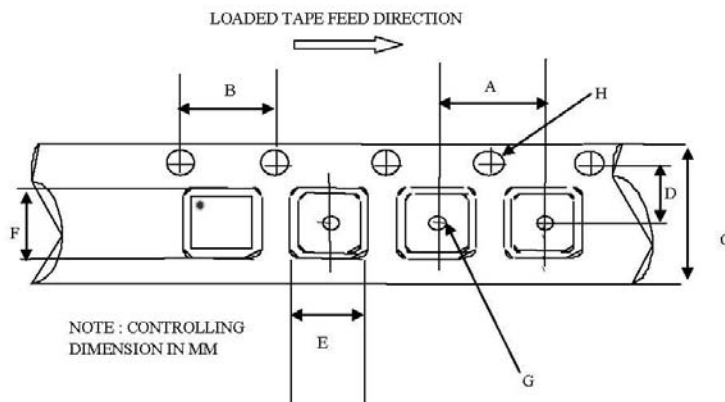
Package Details: MLPQ 4x4 -16L



SYMBOL	VGGD-10					
	MILLIMETERS			INCHES		
	MIN	NOM	MAX	MIN	NOM	MAX
A	0.80	0.90	1.00	.032	.035	.039
A1	0.00	0.02	0.05	.000	.0008	.0019
A3	0.20 REF			.008 REF		
b	0.18	0.25	0.30	.007	.010	.012
D2	1.78	1.88	1.98	.070	.074	.078
D	4.00 BSC			.157 BSC		
E	4.00 BSC			.157 BSC		
E2	1.78	1.88	1.98	.070	.074	.078
L	0.30	0.40	0.50	.012	.016	.020
e	0.50 PITCH			.020 PITCH		
N	16			16		
ND	4			4		
NE	4			4		
aaa	0.15			.0059		
bbb	0.10			.0039		
ccc	0.10			.0039		
ddd	0.05			.0019		

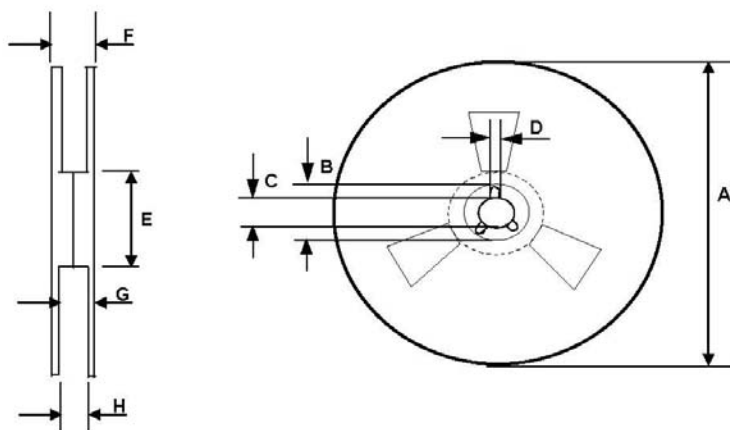


**Tape and Reel Details: MLPQ 4x4**



CARRIER TAPE DIMENSION FOR MLPQ4X4V

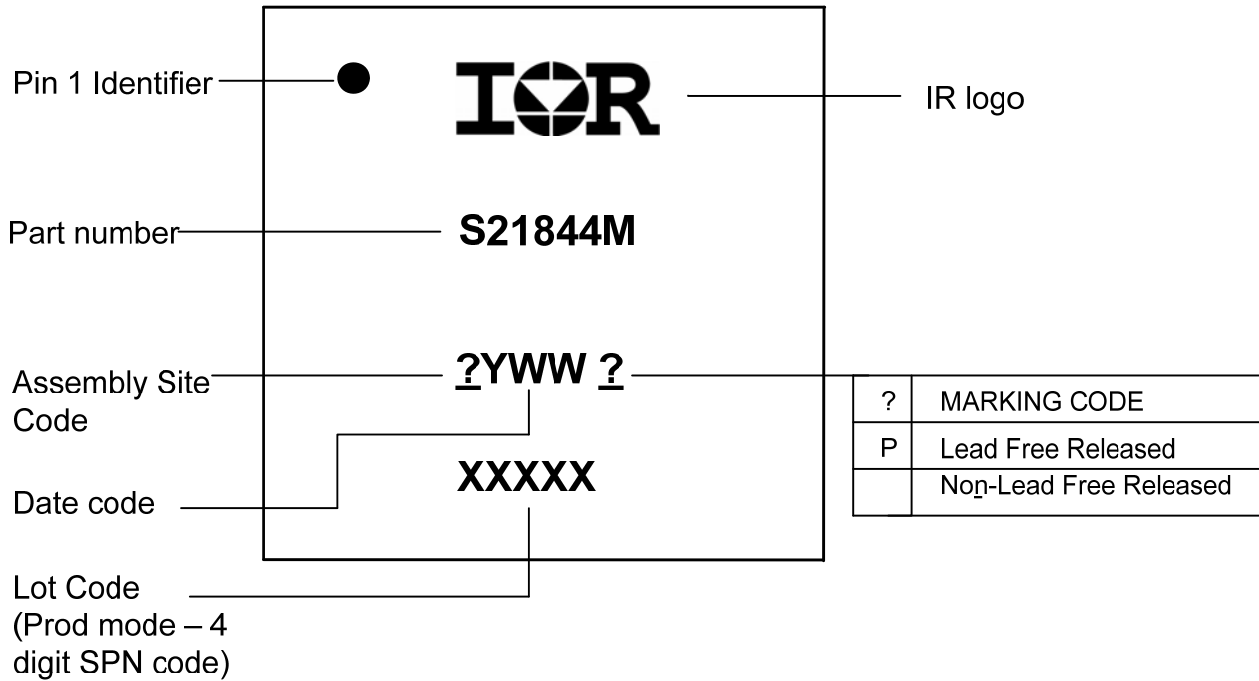
Code	Metric		Imperial	
	Min	Max	Min	Max
A	7.90	8.10	0.311	0.358
B	3.90	4.10	0.154	0.161
C	11.70	12.30	0.461	0.484
D	5.45	5.55	0.215	0.219
E	4.25	4.45	0.168	0.176
F	4.25	4.45	0.168	0.176
G	1.50	n/a	0.059	n/a
H	1.50	1.60	0.059	0.063



REEL DIMENSIONS FOR MLPQ4X4V

Code	Metric		Imperial	
	Min	Max	Min	Max
A	329.60	330.25	12.976	13.001
B	20.95	21.45	0.824	0.844
C	12.80	13.20	0.503	0.519
D	1.95	2.45	0.767	0.096
E	98.00	102.00	3.858	4.015
F	n/a	18.40	n/a	0.724
G	14.50	17.10	0.570	0.673
H	12.40	14.40	0.488	0.566

**Part Marking Information**



**Ordering Information**

Base Part Number	Package Type	Standard Pack		Complete Part Number
		Form	Quantity	
IRS21844	MLPQ 4x4-16L	Tube/Bulk	92	IRS21844MPBF
		<i>Tape and Reel</i>	<i>3,000</i>	IRS21844MTRPBF

The information provided in this document is believed to be accurate and reliable. However, International Rectifier assumes no responsibility for the consequences of the use of this information. International Rectifier assumes no responsibility for any infringement of patents or of other rights of third parties which may result from the use of this information. No license is granted by implication or otherwise under any patent or patent rights of International Rectifier. The specifications mentioned in this document are subject to change without notice. This document supersedes and replaces all information previously supplied.

For technical support, please contact IR's Technical Assistance Center  
<http://www.irf.com/technical-info/>

**WORLD HEADQUARTERS:**  
 233 Kansas St., El Segundo, California 90245  
 Tel: (310) 252-7105