

# IRLR/U120NPbF

HEXFET® Power MOSFET

- Surface Mount (IRLR120N)
- Straight Lead (IRLU120N)
- Advanced Process Technology
- Fast Switching
- Fully Avalanche Rated
- Lead-Free

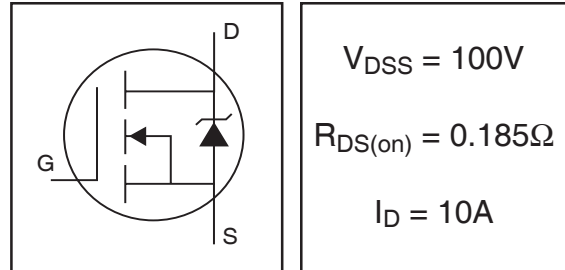

## Description

Fifth Generation HEXFETs from International Rectifier utilize advanced processing techniques to achieve the lowest possible on-resistance per silicon area. This benefit, combined with the fast switching speed and ruggedized device design that HEXFET Power MOSFETs are well known for, provides the designer with an extremely efficient device for use in a wide variety of applications.

The D-PAK is designed for surface mounting using vapor phase, infrared, or wave soldering techniques. The straight lead version (IRFU series) is for through-hole mounting applications. Power dissipation levels up to 1.5 watts are possible in typical surface mount applications.

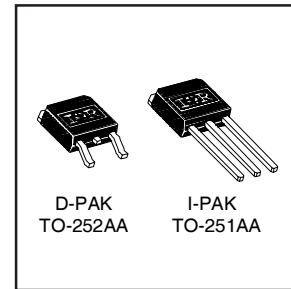

## Absolute Maximum Ratings

	Parameter	Max.	Units
$I_D @ T_C = 25^\circ\text{C}$	Continuous Drain Current, $V_{GS} @ 10\text{V}$	10	A
$I_D @ T_C = 100^\circ\text{C}$	Continuous Drain Current, $V_{GS} @ 10\text{V}$	7.0	
$I_{DM}$	Pulsed Drain Current ①⑥	35	
$P_D @ T_C = 25^\circ\text{C}$	Power Dissipation	48	W
	Linear Derating Factor	0.32	W/°C
$V_{GS}$	Gate-to-Source Voltage	$\pm 16$	V
$E_{AS}$	Single Pulse Avalanche Energy②⑥	85	mJ
$I_{AR}$	Avalanche Current①⑥	6.0	A
$E_{AR}$	Repetitive Avalanche Energy①⑥	4.8	mJ
dv/dt	Peak Diode Recovery dv/dt ③	5.0	V/ns
$T_J$	Operating Junction and	-55 to + 175	°C
$T_{STG}$	Storage Temperature Range		
	Soldering Temperature, for 10 seconds	300 (1.6mm from case )	

## Thermal Resistance

	Parameter	Typ.	Max.	Units
$R_{\theta JC}$	Junction-to-Case	—	3.1	°C/W
$R_{\theta JA}$	Junction-to-Ambient (PCB mount) **	—	50	
$R_{\theta JA}$	Junction-to-Ambient	—	110	

## Electrical Characteristics @ T<sub>J</sub> = 25°C (unless otherwise specified)

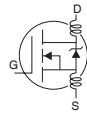
	Parameter	Min.	Typ.	Max.	Units	Conditions
V <sub>(BR)DSS</sub>	Drain-to-Source Breakdown Voltage	100	—	—	V	V <sub>GS</sub> = 0V, I <sub>D</sub> = 250μA
ΔV <sub>(BR)DSS</sub> /ΔT <sub>J</sub>	Breakdown Voltage Temp. Coefficient	—	0.12	—	V/°C	Reference to 25°C, I <sub>D</sub> = 1mA
R <sub>DS(on)</sub>	Static Drain-to-Source On-Resistance	—	—	0.185	W	V <sub>GS</sub> = 10V, I <sub>D</sub> = 6.0A ④
		—	—	0.225		V <sub>GS</sub> = 5.0V, I <sub>D</sub> = 6.0A ④
		—	—	0.265		V <sub>GS</sub> = 4.0V, I <sub>D</sub> = 5.0A ④
V <sub>GS(th)</sub>	Gate Threshold Voltage	1.0	—	2.0	V	V <sub>DS</sub> = V <sub>GS</sub> , I <sub>D</sub> = 250μA
g <sub>fs</sub>	Forward Transconductance	3.1	—	—	S	V <sub>DS</sub> = 25V, I <sub>D</sub> = 6.0A⑥
I <sub>DSS</sub>	Drain-to-Source Leakage Current	—	—	25	μA	V <sub>DS</sub> = 100V, V <sub>GS</sub> = 0V
		—	—	250		V <sub>DS</sub> = 80V, V <sub>GS</sub> = 0V, T <sub>J</sub> = 150°C
I <sub>GSS</sub>	Gate-to-Source Forward Leakage	—	—	100	nA	V <sub>GS</sub> = 16V
	Gate-to-Source Reverse Leakage	—	—	-100		V <sub>GS</sub> = -16V
Q <sub>g</sub>	Total Gate Charge	—	—	20	nC	I <sub>D</sub> = 6.0A
Q <sub>gs</sub>	Gate-to-Source Charge	—	—	4.6		V <sub>DS</sub> = 80V
Q <sub>gd</sub>	Gate-to-Drain ("Miller") Charge	—	—	10		V <sub>GS</sub> = 5.0V, See Fig. 6 and 13 ④⑥
t <sub>d(on)</sub>	Turn-On Delay Time	—	4.0	—	ns	V <sub>DD</sub> = 50V
t <sub>r</sub>	Rise Time	—	35	—		I <sub>D</sub> = 6.0A
t <sub>d(off)</sub>	Turn-Off Delay Time	—	23	—		R <sub>G</sub> = 11Ω, V <sub>GS</sub> = 5.0V
t <sub>f</sub>	Fall Time	—	22	—		R <sub>D</sub> = 8.2Ω, See Fig. 10 ④⑥
L <sub>D</sub>	Internal Drain Inductance	—	4.5	—	nH	Between lead, 6mm (0.25in.) from package and center of die contact⑤
L <sub>S</sub>	Internal Source Inductance	—	7.5	—		
C <sub>iss</sub>	Input Capacitance	—	440	—	pF	V <sub>GS</sub> = 0V
C <sub>oss</sub>	Output Capacitance	—	97	—		V <sub>DS</sub> = 25V
C <sub>rss</sub>	Reverse Transfer Capacitance	—	50	—		f = 1.0MHz, See Fig. 5⑥

## Source-Drain Ratings and Characteristics

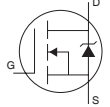
	Parameter	Min.	Typ.	Max.	Units	Conditions
I <sub>S</sub>	Continuous Source Current (Body Diode)	—	—	10	A	MOSFET symbol showing the integral reverse p-n junction diode. 
I <sub>SM</sub>	Pulsed Source Current (Body Diode) ①⑥	—	—	35		
V <sub>SD</sub>	Diode Forward Voltage	—	—	1.3	V	T <sub>J</sub> = 25°C, I <sub>S</sub> = 6.0A, V <sub>GS</sub> = 0V ④
t <sub>rr</sub>	Reverse Recovery Time	—	110	160	ns	T <sub>J</sub> = 25°C, I <sub>F</sub> = 6.0A
Q <sub>rr</sub>	Reverse Recovery Charge	—	410	620	nC	di/dt = 100A/μs ④⑥
t <sub>on</sub>	Forward Turn-On Time	Intrinsic turn-on time is negligible (turn-on is dominated by L <sub>S</sub> +L <sub>D</sub> )				

### Notes:

- ① Repetitive rating; pulse width limited by max. junction temperature. ( See fig. 11 )
- ② V<sub>DD</sub> = 25V, starting T<sub>J</sub> = 25°C, L = 4.7mH R<sub>G</sub> = 25Ω, I<sub>AS</sub> = 6.0A. (See Figure 12)
- ③ I<sub>SD</sub> ≤ 6.0A, di/dt ≤ 340A/μs, V<sub>DD</sub> ≤ V<sub>(BR)DSS</sub>, T<sub>J</sub> ≤ 175°C
- ④ Pulse width ≤ 300μs; duty cycle ≤ 2%.
- ⑤ This is applied for I-PAK, L<sub>S</sub> of D-PAK is measured between lead and center of die contact
- ⑥ Uses IRL520N data and test conditions.

\*\* When mounted on 1" square PCB (FR-4 or G-10 Material ) .  
For recommended footprint and soldering techniques refer to application note #AN-994

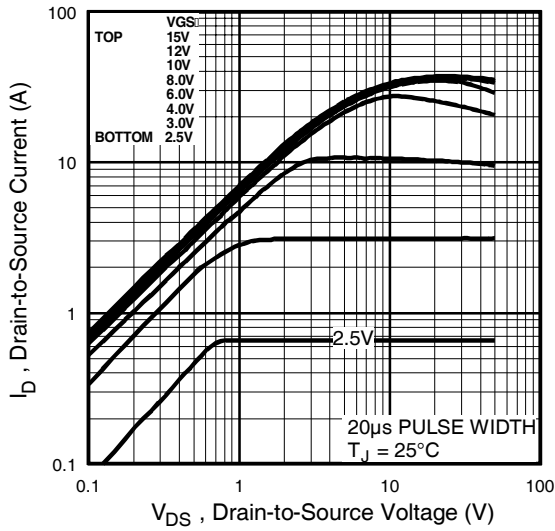

Fig 1. Typical Output Characteristics

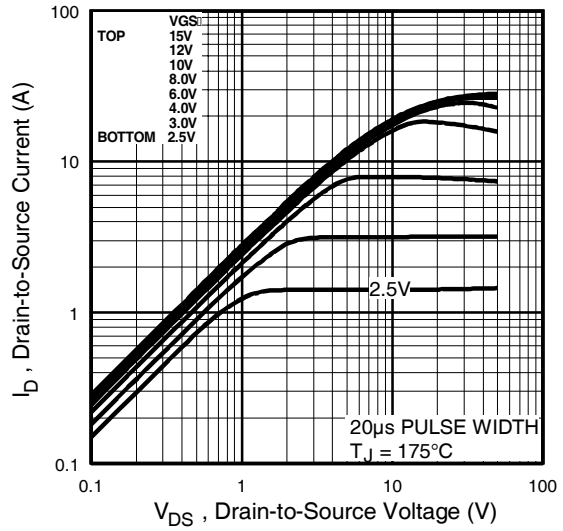

Fig 2. Typical Output Characteristics

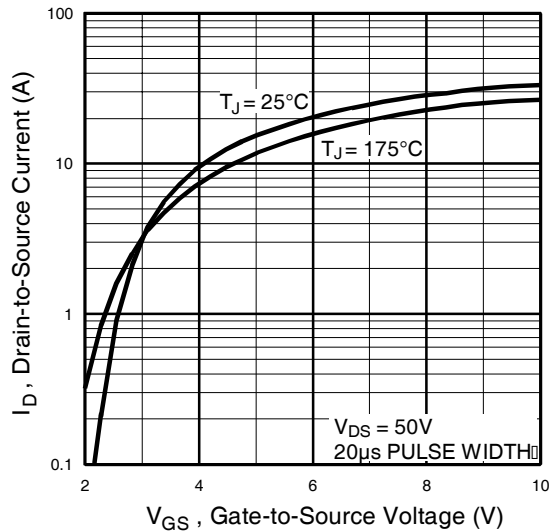

Fig 3. Typical Transfer Characteristics

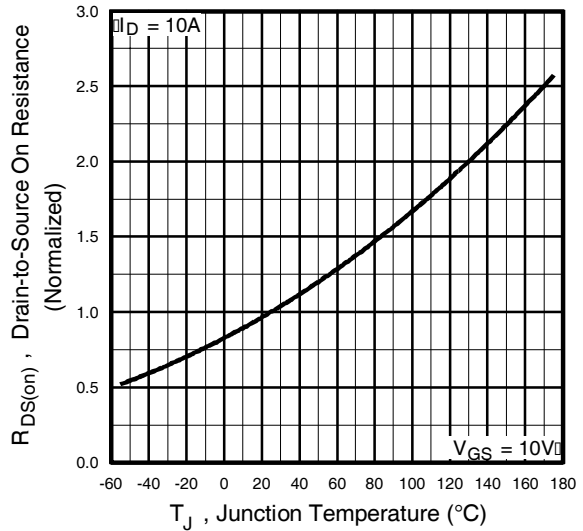
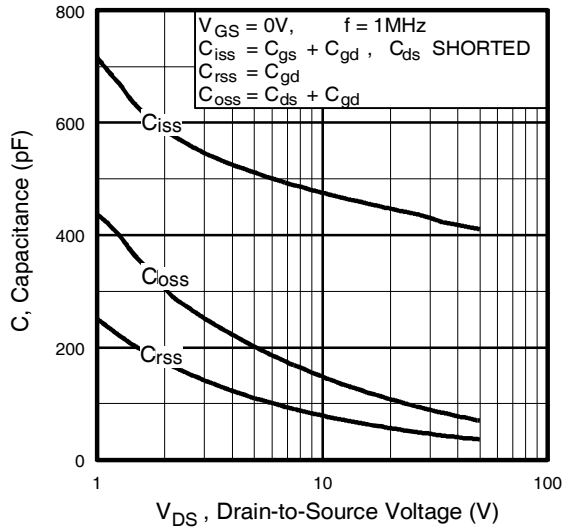
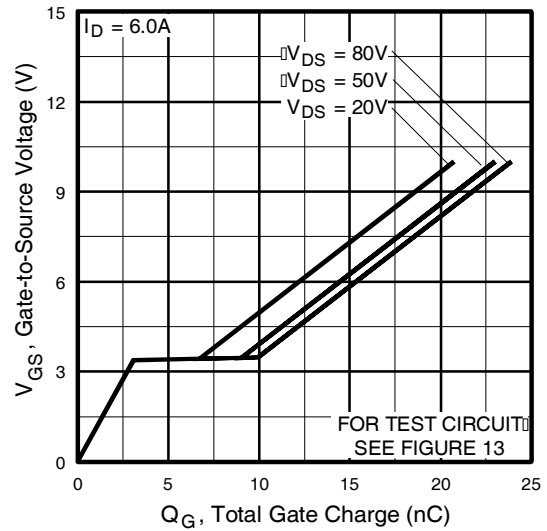

Fig 4. Normalized On-Resistance Vs. Temperature



**Fig 5.** Typical Capacitance Vs. Drain-to-Source Voltage



**Fig 6.** Typical Gate Charge Vs. Gate-to-Source Voltage

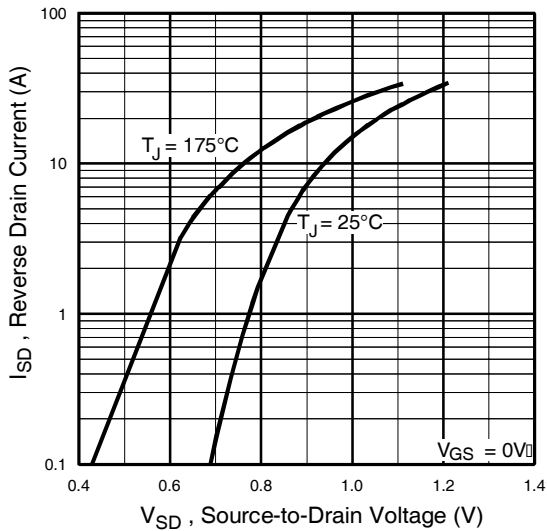

**Fig 7.** Typical Source-Drain Diode Forward Voltage

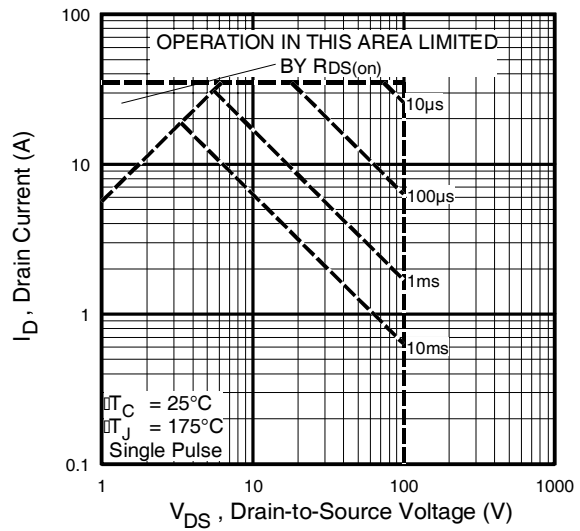

**Fig 8.** Maximum Safe Operating Area

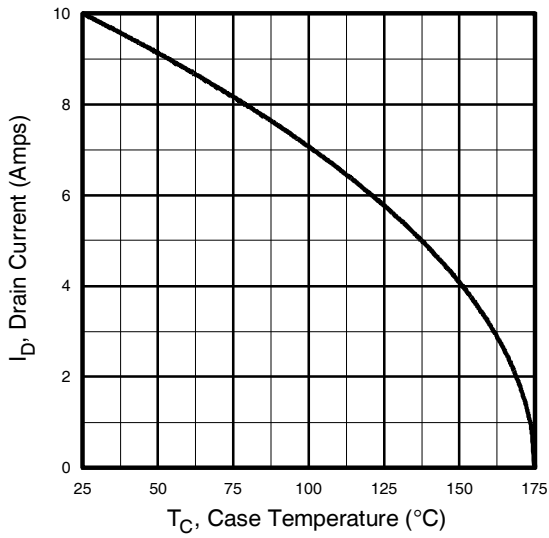

**Fig 9.** Maximum Drain Current Vs. Case Temperature

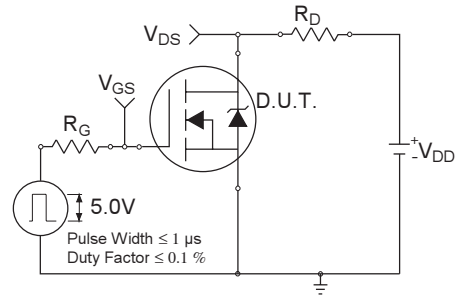

**Fig 10a.** Switching Time Test Circuit

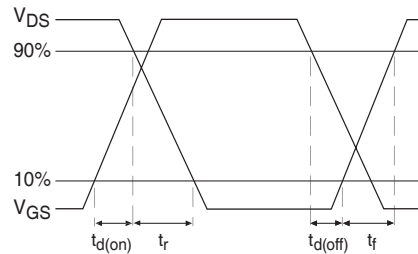

**Fig 10b.** Switching Time Waveforms

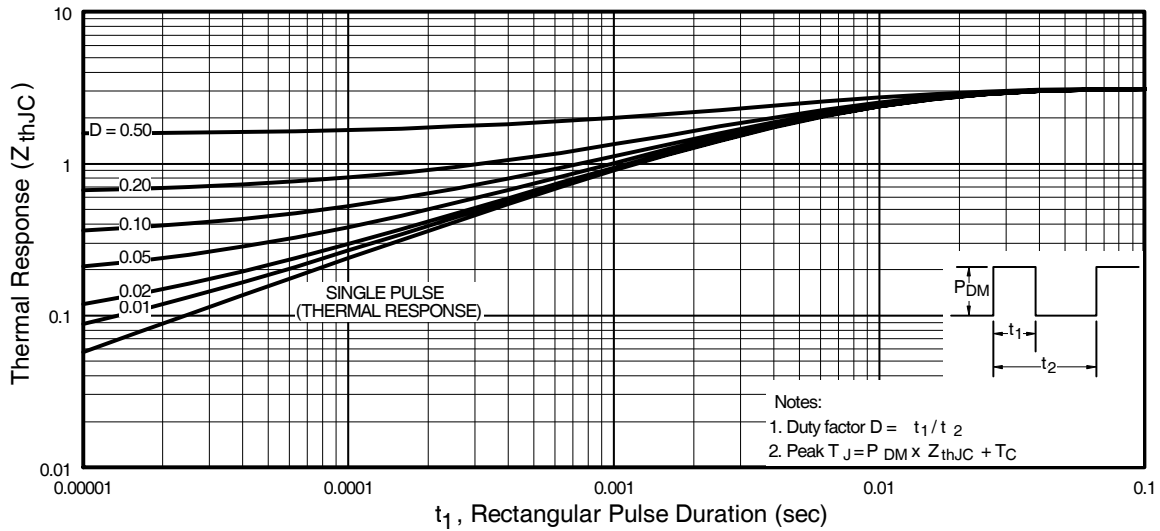

**Fig 11.** Maximum Effective Transient Thermal Impedance, Junction-to-Case

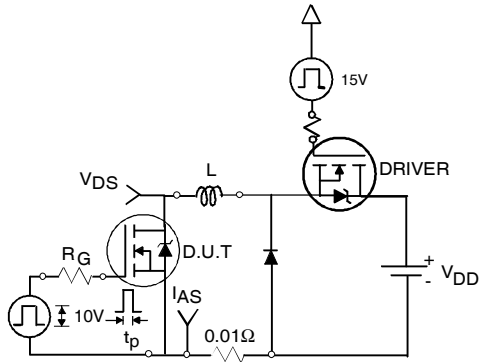

Fig 12a. Unclamped Inductive Test Circuit

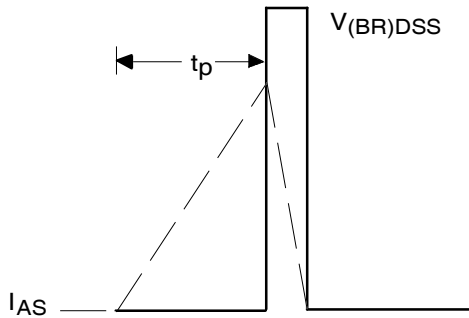

Fig 12b. Unclamped Inductive Waveforms

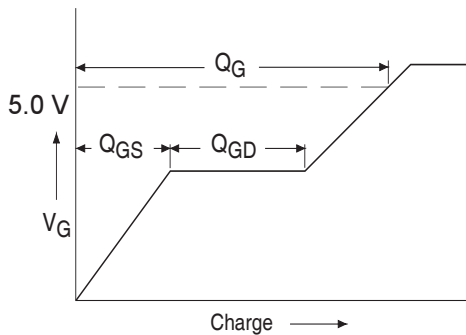

Fig 13a. Basic Gate Charge Waveform

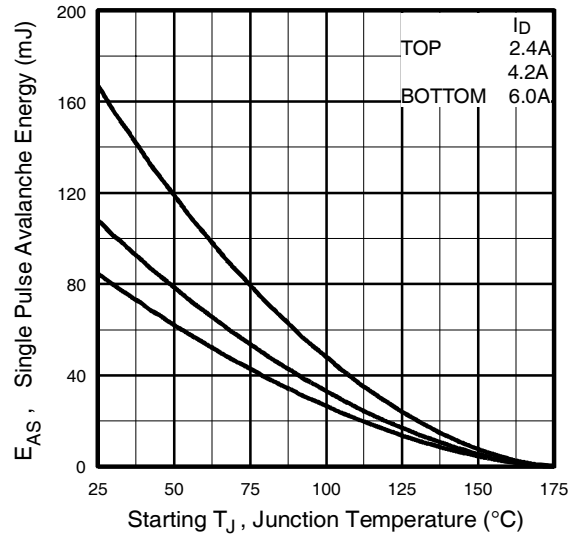

Fig 12c. Maximum Avalanche Energy Vs. Drain Current

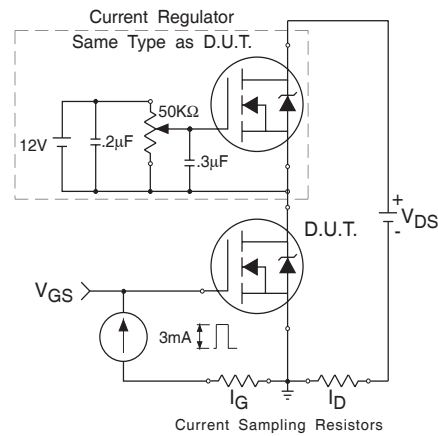
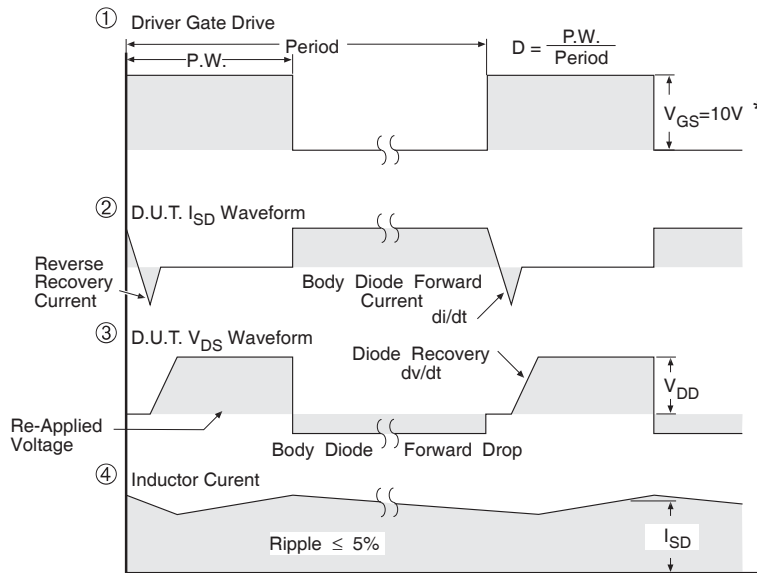
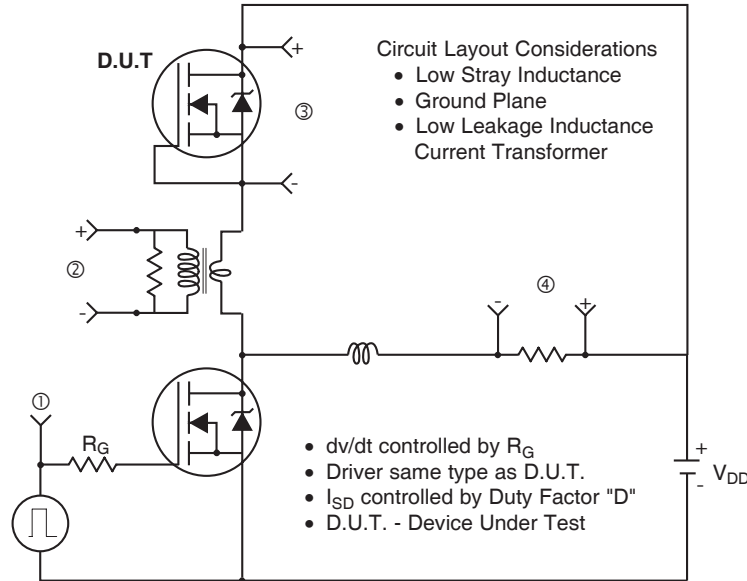

Fig 13b. Gate Charge Test Circuit

**Peak Diode Recovery dv/dt Test Circuit**



\*  $V_{GS} = 5V$  for Logic Level Devices

**Fig 14. For N-Channel HEXFETS**

# IRLR/U120NPbF

International  
**IRF** Rectifier

## D-Pak (TO-252AA) Package Outline

Dimensions are shown in millimeters (inches)

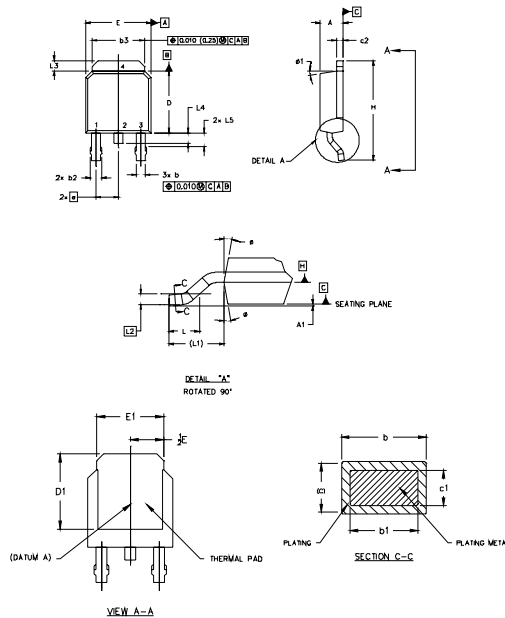

NOTES:  
1.0 DIMENSIONING AND TOLERANCING PER ASME Y14.5 M-1994.  
2.0 DIMENSIONS ARE SHOWN IN INCHES (MILLIMETERS).  
3.0 LEAD DIMENSION UNCONTROLLED IN L5.  
4.0 DIMENSION D1 AND E1 ESTABLISH A MINIMUM MOUNTING SURFACE FOR THERMAL PAD.  
5.0 SECTION C-C DIMENSIONS APPLY TO THE FLAT SECTION OF THE LEAD BETWEEN .005 (0.127) AND .010 (0.254) FROM THE LEAD TIP.  
6.0 DIMENSION D & E DO NOT INCLUDE MOLD FLASH. MOLD FLASH SHALL NOT EXCEED .005" (0.127) PER SIDE. THESE DIMENSIONS ARE MEASURED AT THE OUTERMOST EXTREMES OF THE PLASTIC BODY.  
7.0 OUTLINE CONFORMS TO JEDEC OUTLINE TO-252AA.

SYMBOL	DIMENSIONS				NOTES
	MILLIMETERS		INCHES		
	MIN.	MAX.	MIN.	MAX.	
A	2.18	2.39	.086	.094	
A1	0.15	0.15	.006	.006	
B	0.64	0.89	.025	.035	5
b1	0.64	0.79	.025	0.031	5
b2	0.76	1.14	.030	.045	
b3	4.95	5.46	.195	.215	
C	0.48	0.51	.018	.020	5
c1	0.41	0.36	.016	.014	5
c2	.046	0.09	.018	.036	5
D	5.97	6.32	.235	.249	6
D1	5.21	-	.205	-	4
E	6.35	6.73	.250	.265	6
E1	4.52	-	.178	-	4
H	-	2.29	-	.090 BSC	
Jc	9.40	10.41	.370	.410	
L	1.40	1.78	.055	.070	
L1	2.74 REF	-	108 REF	-	
L2	0.01 BSC	-	.010 BSC	-	
L3	0.89	1.27	.035	.050	
L4	-	1.02	-	.040	
L5	1.14	1.52	.045	.060	3
#	07	107	07	107	
#1	07	107	07	107	

LEAD ASSIGNMENTS  
HEXFET  
1- GATE  
2- DRAIN  
3- SOURCE  
4- DRAIN  
G2Bts, G2PACK  
1- GATE  
2- COLLECTOR  
3- EMITTER  
4- COLLECTOR

## D-Pak (TO-252AA) Part Marking Information

EXAMPLE: THIS IS AN IRFR120  
WITH ASSEMBLY  
LOT CODE 1234  
ASSEMBLED ON WW 16, 1999  
IN THE ASSEMBLY LINE "A"

Note: "P" in assembly line position  
indicates "Lead-Free"

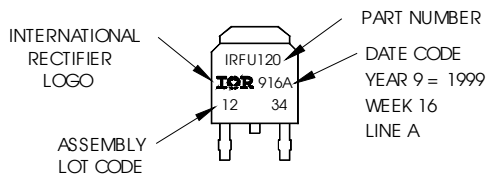

OR

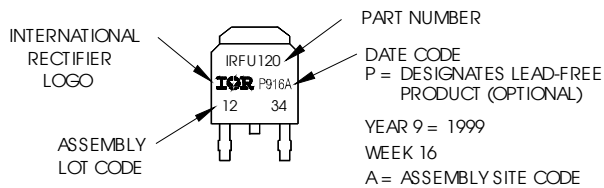



## I-Pak (TO-251AA) Package Outline

Dimensions are shown in millimeters (inches)

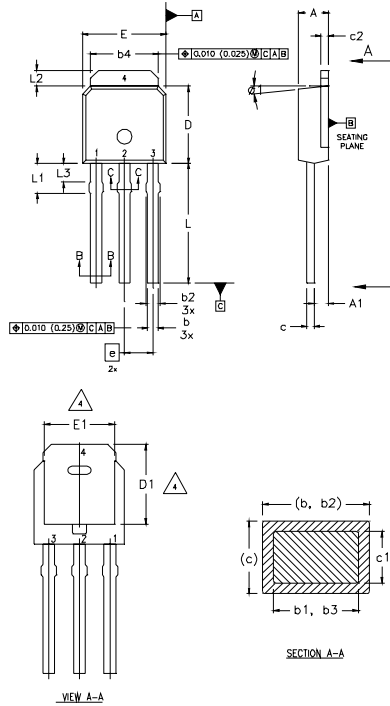

**NOTES:**

- 1 DIMENSIONING AND TOLERANCING PER ASME Y14.5 M- 1994.
- 2 DIMENSIONS ARE SHOWN IN MILLIMETERS [INCHES].
- 3 DIMENSION D & E DO NOT INCLUDE MOLD FLASH. MOLD FLASH SHALL NOT EXCEED 0.005" (0.127) PER SIDE. THESE DIMENSIONS ARE MEASURED AT THE OUTERMOST EXTREMES OF THE PLASTIC BODY.
- 4 THERMAL PAD CONTOUR OPTION WITHIN DIMENSION b4, L2, E1 & D1.
- 5 LEAD DIMENSION UNCONTROLLED IN L3.
- 6 DIMENSION b1, b3 APPLY TO BASE METAL ONLY.
- 7 OUTLINE CONFORMS TO JEDEC OUTLINE TO-251AA.
- 8 CONTROLLING DIMENSION : INCHES.

**LEAD ASSIGNMENTS**

- HEXFEET**
- 1.- GATE
  - 2.- DRAIN
  - 3.- SOURCE
  - 4.- DRAIN

SYMBOL	DIMENSIONS				NOTES
	MILLIMETERS		INCHES		
	MIN.	MAX.	MIN.	MAX.	
A	2.18	2.39	0.086	.094	
A1	0.89	1.14	0.035	0.045	
b	0.64	0.89	0.025	0.035	
b1	0.64	0.79	0.025	0.031	4
b2	0.76	1.14	0.030	0.045	
b3	0.76	1.04	0.030	0.041	
b4	5.00	5.46	0.196	0.215	4
c	0.46	0.61	0.018	0.024	
c1	0.41	0.56	0.016	0.022	
c2	.046	0.06	0.018	0.035	3, 4
D	5.97	6.22	0.235	0.245	4
D1	5.21	-	0.205	-	4
E	6.35	6.73	0.250	0.265	3, 4
E1	4.32	-	0.170	-	4
e	2.29		0.090 BSC		
L	8.89	9.60	0.350	0.380	
L1	1.91	2.29	0.075	0.090	
L2	0.89	1.27	0.035	0.050	4
L3	1.14	1.52	0.045	0.060	5
ø1	0'	15'	0'	15'	

## I-Pak (TO-251AA) Part Marking Information

EXAMPLE: THIS IS AN IRFU120 WITH ASSEMBLY LOT CODE 5678 ASSEMBLED ON WW19, 1999 IN THE ASSEMBLY LINE "A"

**Note:** "P" in assembly line position indicates "Lead-Free"

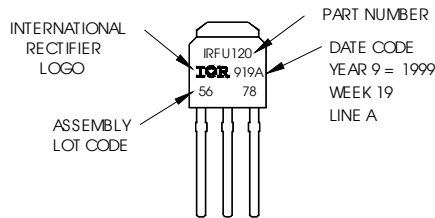

**OR**

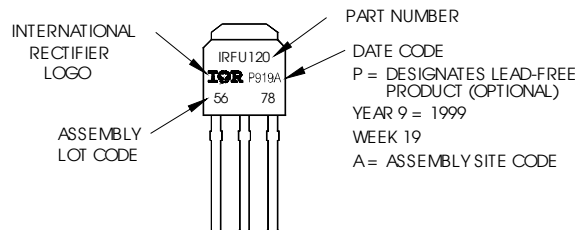

## D-Pak (TO-252AA) Tape & Reel Information

Dimensions are shown in millimeters (inches)

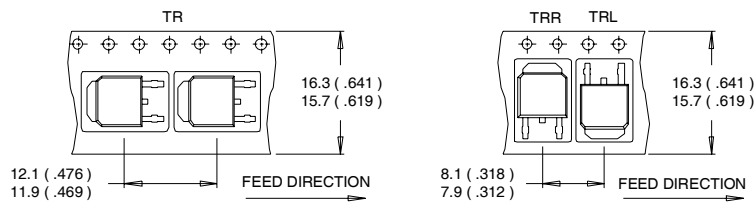

- NOTES:
1. CONTROLLING DIMENSION : MILLIMETER.
  2. ALL DIMENSIONS ARE SHOWN IN MILLIMETERS ( INCHES ).
  3. OUTLINE CONFORMS TO EIA-481 & EIA-541.

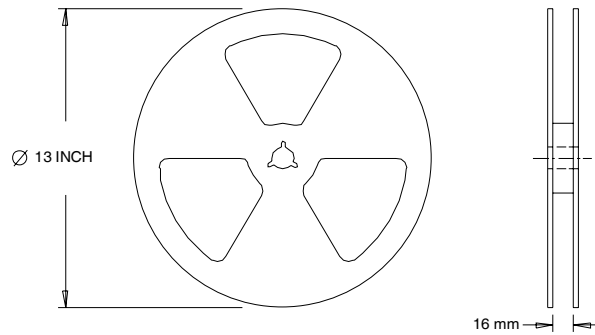

- NOTES:
1. OUTLINE CONFORMS TO EIA-481.

Data and specifications subject to change without notice.

International  
**IR** Rectifier

**IR WORLD HEADQUARTERS:** 233 Kansas St., El Segundo, California 90245, USA Tel: (310) 252-7105  
TAC Fax: (310) 252-7903

Visit us at [www.irf.com](http://www.irf.com) for sales contact information.12/04

[www.irf.com](http://www.irf.com)

Note: For the most current drawings please refer to the IR website at:  
<http://www.irf.com/package/>