

IRFH7921PbF

HEXFET® Power MOSFET

Applications

- High Frequency Point-of-Load Synchronous Buck Converter for Applications in Networking & Computing Systems
- Optimized for Control FET Applications

V_{DSS}	$R_{DS(on)}$ max	Qg
30V	8.5mΩ @ $V_{GS} = 10V$	9.3nC

Benefits

- Very low $R_{DS(ON)}$ at 4.5V V_{GS}
- Low Gate Charge
- Fully Characterized Avalanche Voltage and Current
- 100% Tested for R_G
- Lead-Free (Qualified up to 260°C Reflow)
- RoHS compliant (Halogen Free)
- Low Thermal Resistance
- Large Source Lead for more reliable Soldering

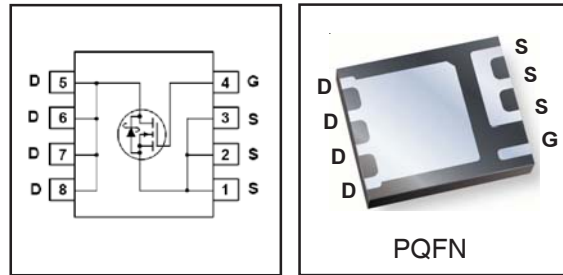

Absolute Maximum Ratings

	Parameter	Max.	Units
V_{DS}	Drain-to-Source Voltage	30	V
V_{GS}	Gate-to-Source Voltage	± 20	
$I_D @ T_A = 25^\circ C$	Continuous Drain Current, $V_{GS} @ 10V$	15	A
$I_D @ T_A = 70^\circ C$	Continuous Drain Current, $V_{GS} @ 10V$	12	
$I_D @ T_C = 25^\circ C$	Continuous Drain Current, $V_{GS} @ 10V$	34	
I_{DM}	Pulsed Drain Current ①	120	
$P_D @ T_A = 25^\circ C$	Power Dissipation ⑤	3.1	W
$P_D @ T_A = 70^\circ C$	Power Dissipation ⑤	2.0	
	Linear Derating Factor ⑤	0.025	W/°C
T_J	Operating Junction and	-55 to + 150	°C
T_{STG}	Storage Temperature Range		

Thermal Resistance

	Parameter	Typ.	Max.	Units
$R_{\theta JC}$	Junction-to-Case ④	—	7.9	°C/W
$R_{\theta JA}$	Junction-to-Ambient ⑤	—	40	

Notes ① through ⑤ are on page 9

www.irf.com

IRFH7921PbF

International
IR Rectifier

Static @ $T_J = 25^\circ\text{C}$ (unless otherwise specified)

	Parameter	Min.	Typ.	Max.	Units	Conditions
BV_{DSS}	Drain-to-Source Breakdown Voltage	30	—	—	V	$V_{GS} = 0V, I_D = 250\mu A$
$\Delta BV_{DSS}/\Delta T_J$	Breakdown Voltage Temp. Coefficient	—	0.02	—	$V/^\circ\text{C}$	Reference to $25^\circ\text{C}, I_D = 1\text{mA}$
$R_{DS(on)}$	Static Drain-to-Source On-Resistance	—	7.1	8.5	$m\Omega$	$V_{GS} = 10V, I_D = 15A$ ③
		—	10.4	12.5		$V_{GS} = 4.5V, I_D = 12A$ ③
$V_{GS(th)}$	Gate Threshold Voltage	1.35	1.8	2.35	V	$V_{DS} = V_{GS}, I_D = 25\mu A$
$\Delta V_{GS(th)}$	Gate Threshold Voltage Coefficient	—	-6.2	—	$mV/^\circ\text{C}$	
I_{DSS}	Drain-to-Source Leakage Current	—	—	1.0	μA	$V_{DS} = 24V, V_{GS} = 0V$
		—	—	150		$V_{DS} = 24V, V_{GS} = 0V, T_J = 125^\circ\text{C}$
I_{GSS}	Gate-to-Source Forward Leakage	—	—	100	nA	$V_{GS} = 20V$
	Gate-to-Source Reverse Leakage	—	—	-100		$V_{GS} = -20V$
g_{fs}	Forward Transconductance	27	—	—	S	$V_{DS} = 15V, I_D = 12A$
Q_g	Total Gate Charge	—	9.3	14	nC	$V_{DS} = 15V$ $V_{GS} = 4.5V$ $I_D = 12A$ See Fig.17 & 18
Q_{gs1}	Pre-Vth Gate-to-Source Charge	—	2.2	—		
Q_{gs2}	Post-Vth Gate-to-Source Charge	—	1.2	—		
Q_{gd}	Gate-to-Drain Charge	—	3.2	—		
Q_{godr}	Gate Charge Overdrive	—	2.7	—		
Q_{sw}	Switch Charge ($Q_{gs2} + Q_{gd}$)	—	4.4	—		
Q_{oss}	Output Charge	—	5.0	—	nC	$V_{DS} = 16V, V_{GS} = 0V$
R_G	Gate Resistance	—	1.4	2.4	Ω	
$t_{d(on)}$	Turn-On Delay Time	—	12	—	ns	$V_{DD} = 15V, V_{GS} = 4.5V$ $I_D = 12A$ $R_G = 1.8\Omega$ See Fig.15
t_r	Rise Time	—	7.6	—		
$t_{d(off)}$	Turn-Off Delay Time	—	14	—		
t_f	Fall Time	—	4.7	—		
C_{iss}	Input Capacitance	—	1210	—	pF	$V_{GS} = 0V$
C_{oss}	Output Capacitance	—	240	—		$V_{DS} = 15V$
C_{riss}	Reverse Transfer Capacitance	—	120	—		$f = 1.0\text{MHz}$

Avalanche Characteristics

	Parameter	Typ.	Max.	Units
E_{AS}	Single Pulse Avalanche Energy ②	—	29	mJ
I_{AR}	Avalanche Current ①	—	12	A

Diode Characteristics

	Parameter	Min.	Typ.	Max.	Units	Conditions
I_S	Continuous Source Current (Body Diode)	—	—	3.9	A	MOSFET symbol showing the integral reverse p-n junction diode.
I_{SM}	Pulsed Source Current (Body Diode) ①	—	—	120		
V_{SD}	Diode Forward Voltage	—	—	1.0	V	$T_J = 25^\circ\text{C}, I_S = 12A, V_{GS} = 0V$ ③
t_{rr}	Reverse Recovery Time	—	12	18	ns	$T_J = 25^\circ\text{C}, I_F = 12A, V_{DD} = 15V$
Q_{rr}	Reverse Recovery Charge	—	11	17	nC	$di/dt = 300A/\mu s$ ③
t_{on}	Forward Turn-On Time	Intrinsic turn-on time is negligible (turn-on is dominated by LS+LD)				

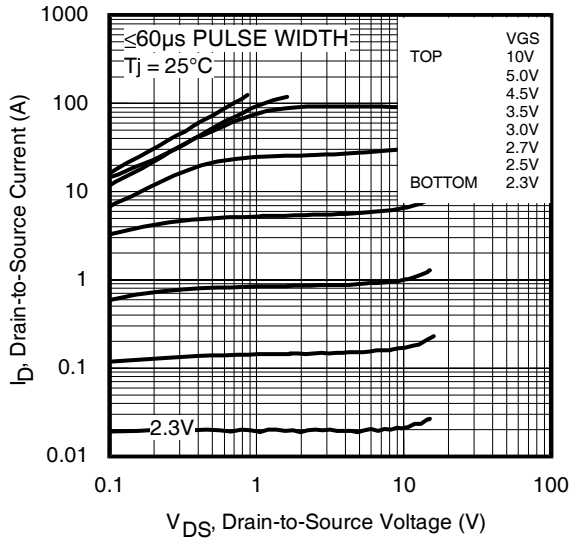

Fig 1. Typical Output Characteristics

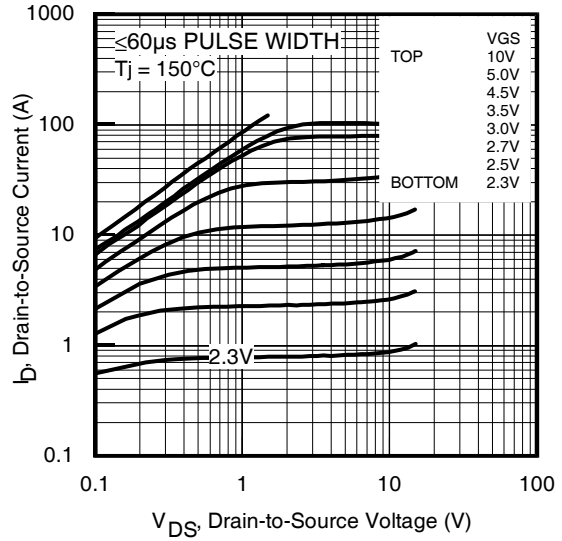

Fig 2. Typical Output Characteristics

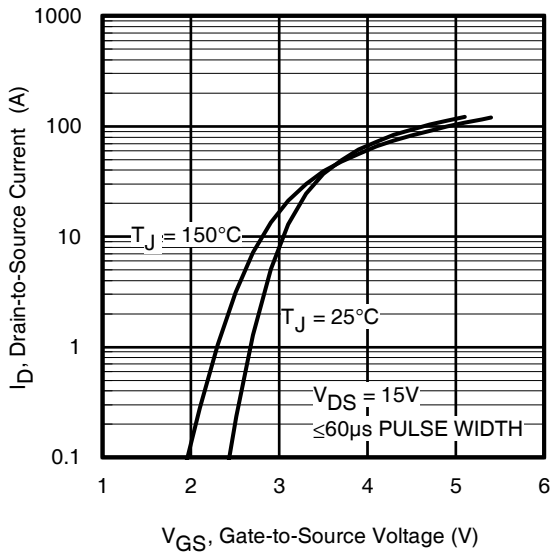

Fig 3. Typical Transfer Characteristics

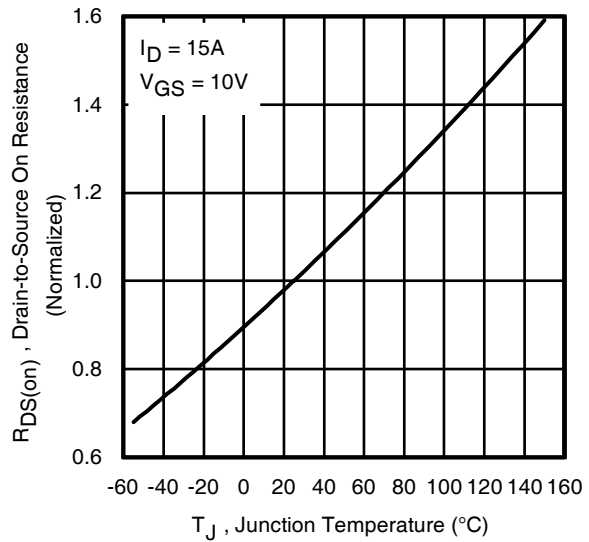

Fig 4. Normalized On-Resistance vs. Temperature

IRFH7921PbF

International
IR Rectifier

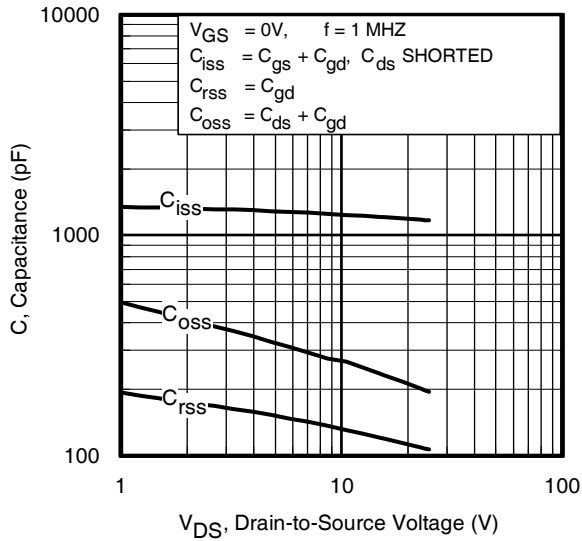

Fig 5. Typical Capacitance vs. Drain-to-Source Voltage

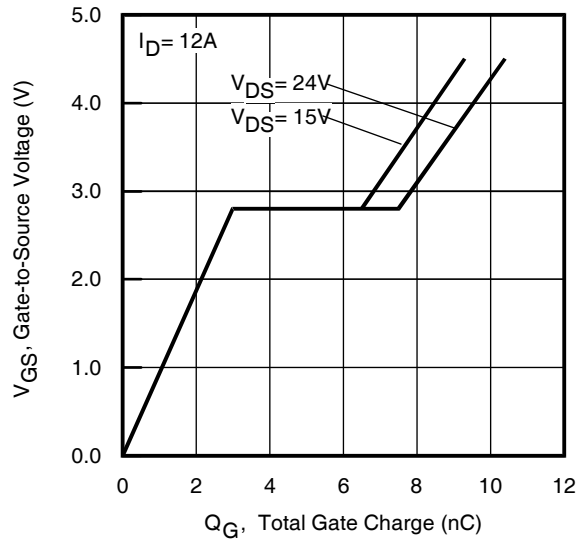

Fig 6. Typical Gate Charge vs. Gate-to-Source Voltage

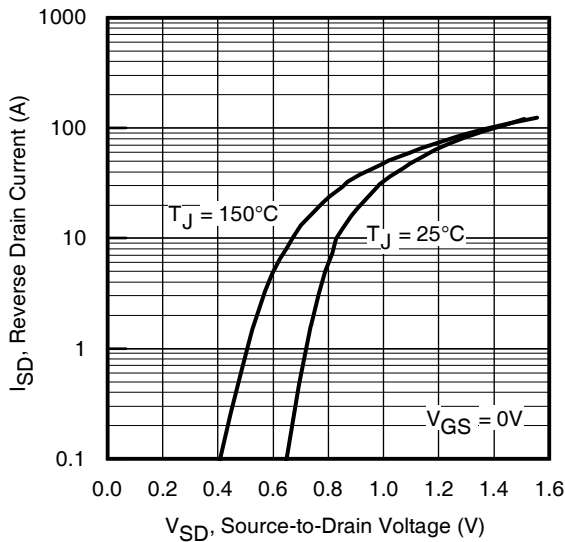

Fig 7. Typical Source-Drain Diode Forward Voltage

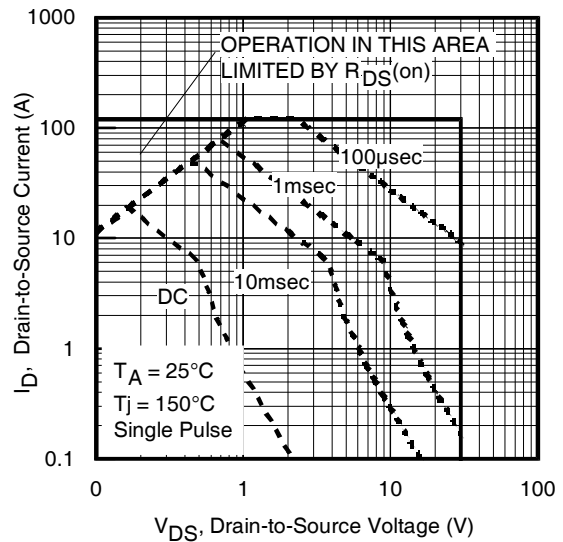

Fig 8. Maximum Safe Operating Area

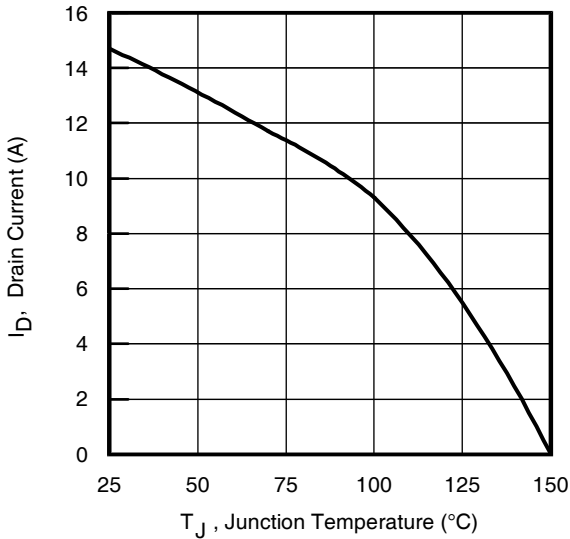

Fig 9. Maximum Drain Current vs. Ambient Temperature

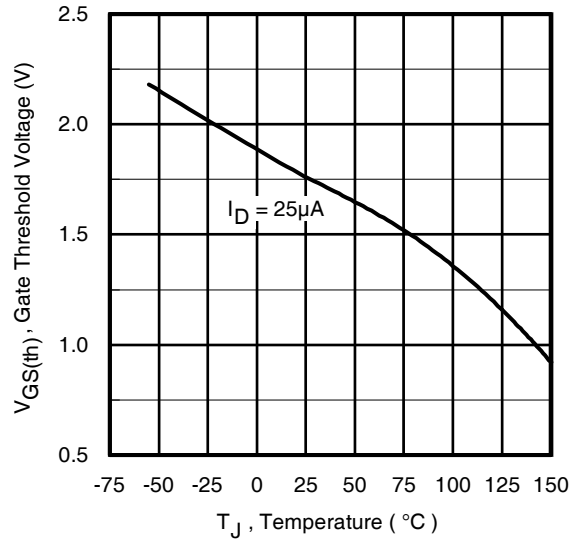

Fig 10. Threshold Voltage vs. Temperature

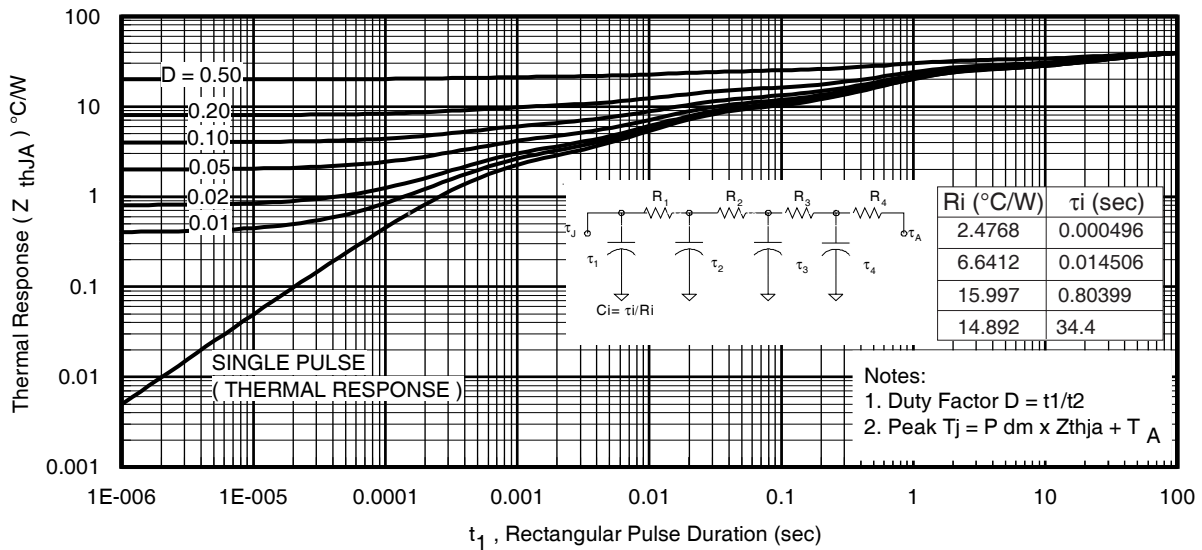

Fig 11. Maximum Effective Transient Thermal Impedance, Junction-to-Ambient

IRFH7921PbF

International
IR Rectifier

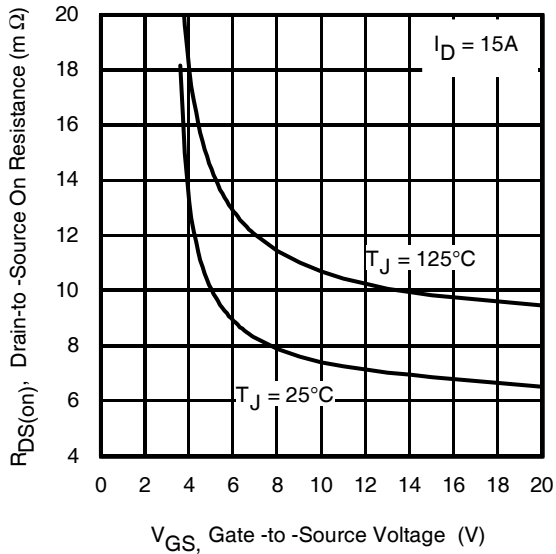

Fig 12. On-Resistance vs. Gate Voltage

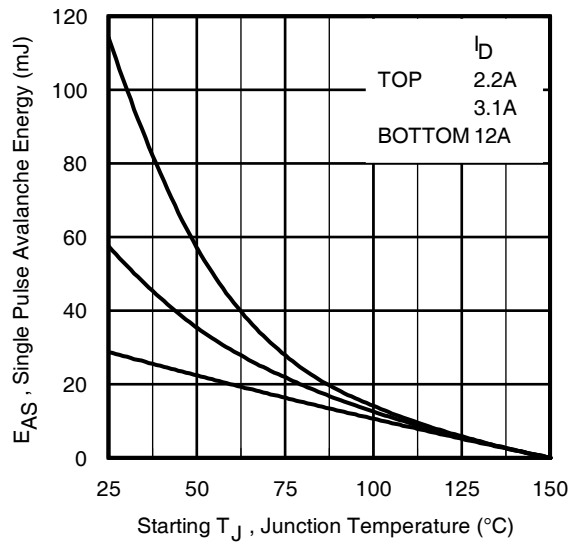

Fig 13. Maximum Avalanche Energy vs. Drain Current

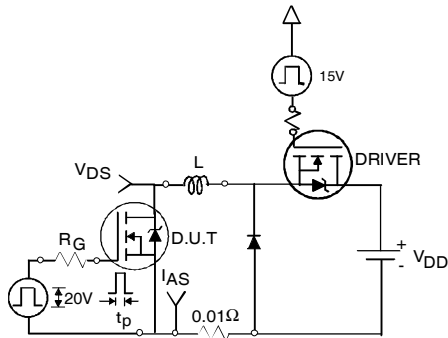

Fig 14a. Unclamped Inductive Test Circuit

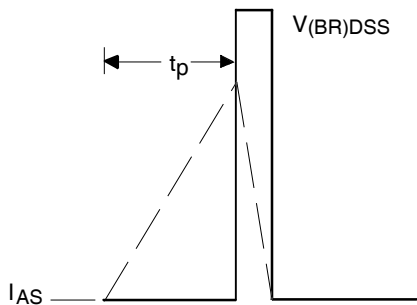

Fig 14b. Unclamped Inductive Waveforms

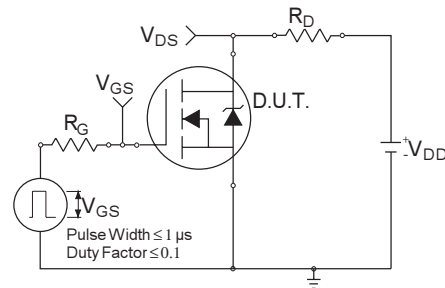

Fig 15a. Switching Time Test Circuit

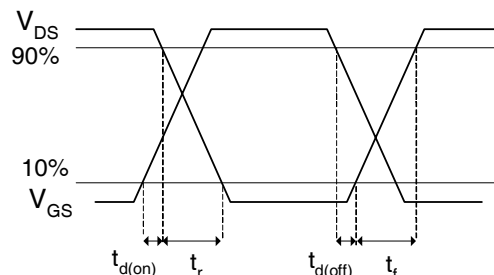

Fig 15b. Switching Time Waveforms

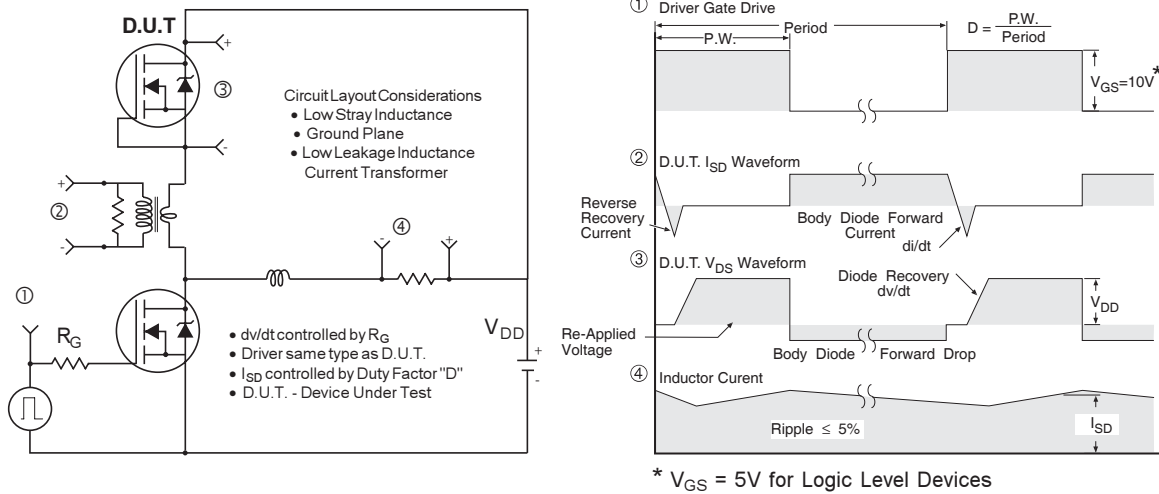

Fig 16. Peak Diode Recovery dv/dt Test Circuit for N-Channel HEXFET® Power MOSFETs

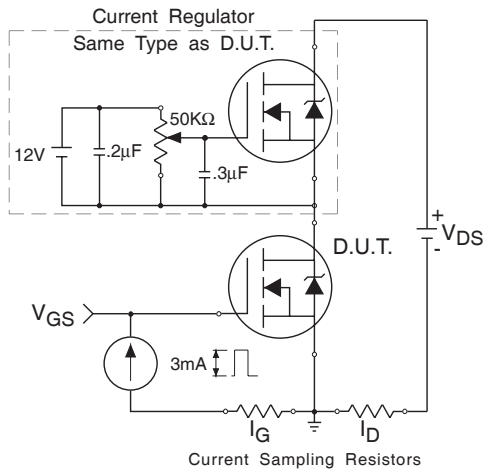

Fig 17. Gate Charge Test Circuit

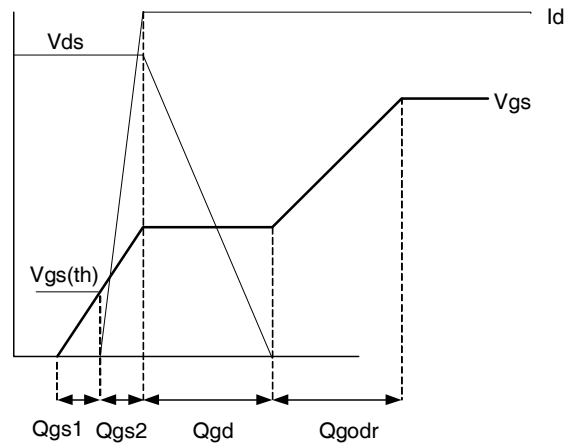
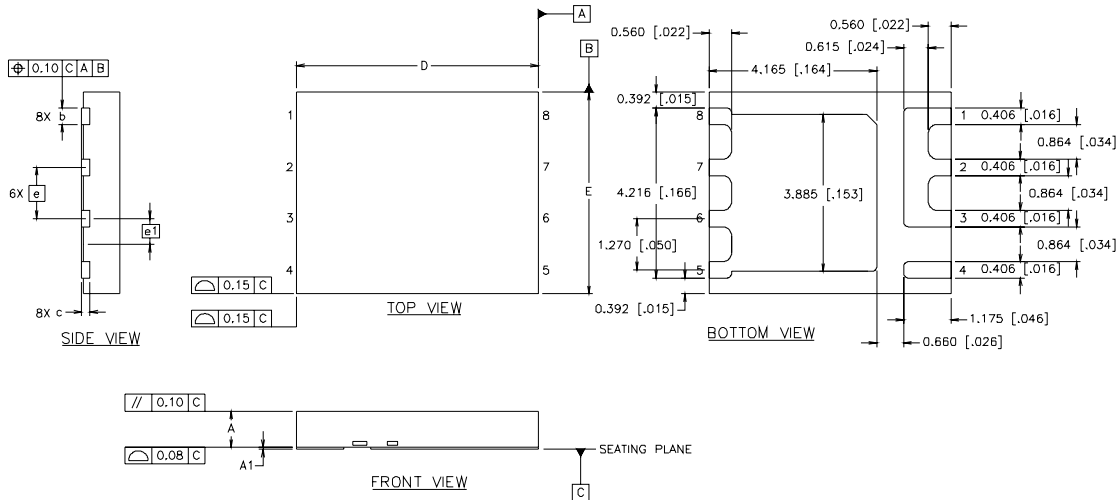

Fig 18. Gate Charge Waveform

IRFH7921PbF

PQFN Package Details

International
IR Rectifier



DIM	INCHES		MILLIMETERS	
	MIN	MAX	MIN	MAX
A	.0315	.0394	0.800	1.000
A1	.0000	.0020	0.000	0.050
b	.0140	.0180	0.356	0.456
c	.0080 REF.		0.203 REF.	
D	.2362 BASIC		6.0 BASIC	
E	.1969 BASIC		5.0 BASIC	
e	.0500 BASIC		1.270 BASIC	
e1	.0250 BASIC		0.635 BASIC	

PQFN Part Marking

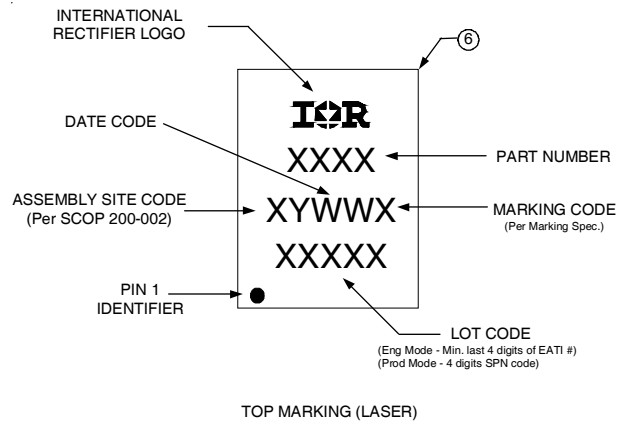

Note: For the most current drawing please refer to IR website at <http://www.irf.com/package/>

PQFN Tape and Reel

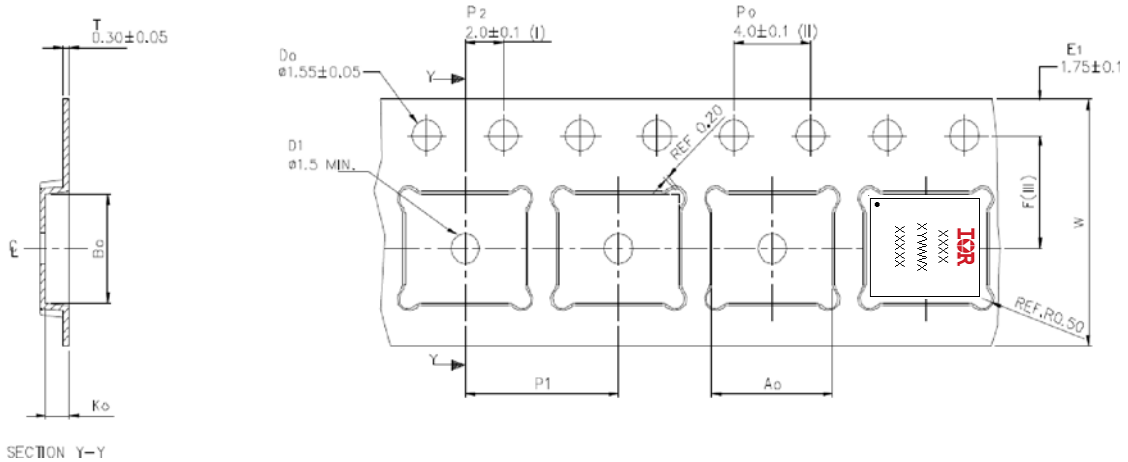

A_0	6.30 +/− 0.1
B_0	5.30 +/− 0.1
K_0	1.20 +/− 0.1
F	5.50 +/− 0.1
P_1	8.00 +/− 0.1
W	12.00 +/− 0.3

- (I) Measured from centreline of sprocket hole to centreline of pocket.
- (II) Cumulative tolerance of 10 sprocket holes is ± 0.20 .
- (III) Measured from centreline of sprocket hole to centreline of pocket.
- (IV) Other material available.
- (V) Typical SR of form tape Max 10^9 OHM/SQ

ALL DIMENSIONS IN MILLIMETRES UNLESS OTHERWISE STATED.

Note: For the most current drawing please refer to IR website at <http://www.irf.com/package/>

Notes:

- ① Repetitive rating; pulse width limited by max. junction temperature.
- ② Starting $T_J = 25^\circ\text{C}$, $L = 0.39\text{mH}$, $R_G = 25\Omega$, $I_{AS} = 12\text{A}$.
- ③ Pulse width ≤ 400µs; duty cycle ≤ 2%.
- ④ R_{thjc} is guaranteed by design
- ⑤ When mounted on 1 inch square 2 oz copper pad on 1.5x1.5 in. board of FR-4 material.

Data and specifications subject to change without notice.
 This product has been designed and qualified for the Consumer market.
 Qualification Standards can be found on IR's Web site.

International
IR Rectifier

IR WORLD HEADQUARTERS: 233 Kansas St., El Segundo, California 90245, USA Tel: (310) 252-7105
 TAC Fax: (310) 252-7903

Visit us at www.irf.com for sales contact information.07/08