

IRF3808S
IRF3808L

HEXFET® Power MOSFET

Typical Applications

- Integrated Starter Alternator
- 42 Volts Automotive Electrical Systems

Benefits

- Advanced Process Technology
- Ultra Low On-Resistance
- Dynamic dv/dt Rating
- 175°C Operating Temperature
- Fast Switching
- Repetitive Avalanche Allowed up to Tjmax

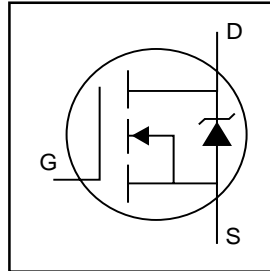

$V_{DSS} = 75V$
$R_{DS(on)} = 0.007\Omega$
$I_D = 106A\text{⑥}$

Description

Designed specifically for Automotive applications, this Advanced Planar Stripe HEXFET® Power MOSFET utilizes the latest processing techniques to achieve extremely low on-resistance per silicon area. Additional features of this HEXFET power MOSFET are a 175°C junction operating temperature, low RθJC, fast switching speed and improved repetitive avalanche rating. This combination makes the design an extremely efficient and reliable choice for use in higher power Automotive electronic systems and a wide variety of other applications.

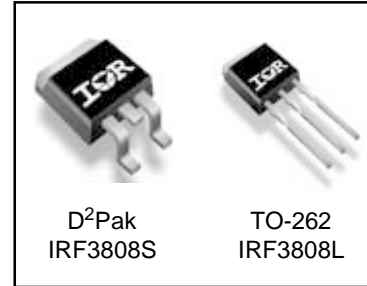

Absolute Maximum Ratings

	Parameter	Max.	Units
$I_D @ T_C = 25^\circ C$	Continuous Drain Current, $V_{GS} @ 10V$	106⑥	A
$I_D @ T_C = 100^\circ C$	Continuous Drain Current, $V_{GS} @ 10V$	75⑥	
I_{DM}	Pulsed Drain Current ①	550	
$P_D @ T_C = 25^\circ C$	Power Dissipation	200	W
	Linear Derating Factor	1.3	W/°C
V_{GS}	Gate-to-Source Voltage	± 20	V
E_{AS}	Single Pulse Avalanche Energy②	430	mJ
I_{AR}	Avalanche Current①	82	A
E_{AR}	Repetitive Avalanche Energy⑦	See Fig.12a, 12b, 15, 16	mJ
dv/dt	Peak Diode Recovery dv/dt ③	5.5	V/ns
T_J	Operating Junction and	-55 to + 175	°C
T_{STG}	Storage Temperature Range		
	Soldering Temperature, for 10 seconds	300 (1.6mm from case)	

Thermal Resistance

	Parameter	Typ.	Max.	Units
$R_{\theta JC}$	Junction-to-Case	—	0.75	°C/W
$R_{\theta JA}$	Junction-to-Ambient (PCB Mounted, Steady State)**	—	40	

HEXFET(R) is a registered trademark of International Rectifier.

Electrical Characteristics @ T_J = 25°C (unless otherwise specified)

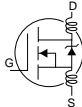
	Parameter	Min.	Typ.	Max.	Units	Conditions
V _{(BR)DSS}	Drain-to-Source Breakdown Voltage	75	—	—	V	V _{GS} = 0V, I _D = 250μA
ΔV _{(BR)DSS} /ΔT _J	Breakdown Voltage Temp. Coefficient	—	0.086	—	V/°C	Reference to 25°C, I _D = 1mA
R _{DS(on)}	Static Drain-to-Source On-Resistance	—	5.9	7.0	mΩ	V _{GS} = 10V, I _D = 82A ④
V _{GS(th)}	Gate Threshold Voltage	2.0	—	4.0	V	V _{DS} = 10V, I _D = 250μA
g _{fs}	Forward Transconductance	100	—	—	S	V _{DS} = 25V, I _D = 82A
I _{DSS}	Drain-to-Source Leakage Current	—	—	20	μA	V _{DS} = 75V, V _{GS} = 0V
		—	—	250		V _{DS} = 60V, V _{GS} = 0V, T _J = 150°C
I _{GSS}	Gate-to-Source Forward Leakage	—	—	200	nA	V _{GS} = 20V
	Gate-to-Source Reverse Leakage	—	—	-200		V _{GS} = -20V
Q _g	Total Gate Charge	—	150	220	nC	I _D = 82A
Q _{gs}	Gate-to-Source Charge	—	31	47		V _{DS} = 60V
Q _{gd}	Gate-to-Drain ("Miller") Charge	—	50	76		V _{GS} = 10V④
t _{d(on)}	Turn-On Delay Time	—	16	—	ns	V _{DD} = 38V
t _r	Rise Time	—	140	—		I _D = 82A
t _{d(off)}	Turn-Off Delay Time	—	68	—		R _G = 2.5Ω
t _f	Fall Time	—	120	—		V _{GS} = 10V ④
L _D	Internal Drain Inductance	—	4.5	—	nH	Between lead, 6mm (0.25in.) from package and center of die contact
L _S	Internal Source Inductance	—	7.5	—		
C _{iss}	Input Capacitance	—	5310	—	pF	V _{GS} = 0V
C _{oss}	Output Capacitance	—	890	—		V _{DS} = 25V
C _{rss}	Reverse Transfer Capacitance	—	130	—		f = 1.0MHz, See Fig. 5
C _{oss}	Output Capacitance	—	6010	—		V _{GS} = 0V, V _{DS} = 1.0V, f = 1.0MHz
C _{oss}	Output Capacitance	—	570	—		V _{GS} = 0V, V _{DS} = 60V, f = 1.0MHz
C _{oss eff.}	Effective Output Capacitance ⑤	—	1140	—		V _{GS} = 0V, V _{DS} = 0V to 60V

Source-Drain Ratings and Characteristics

	Parameter	Min.	Typ.	Max.	Units	Conditions
I _S	Continuous Source Current (Body Diode)	—	—	106⑥	A	MOSFET symbol showing the integral reverse p-n junction diode.
I _{SM}	Pulsed Source Current (Body Diode) ①	—	—	550		
V _{SD}	Diode Forward Voltage	—	—	1.3	V	T _J = 25°C, I _S = 82A, V _{GS} = 0V ④
t _{rr}	Reverse Recovery Time	—	93	140	ns	T _J = 25°C, I _F = 82A
Q _{rr}	Reverse Recovery Charge	—	340	510	nC	di/dt = 100A/μs ④
t _{on}	Forward Turn-On Time	Intrinsic turn-on time is negligible (turn-on is dominated by L _S +L _D)				

Notes:

- ① Repetitive rating; pulse width limited by max. junction temperature. (See fig. 11).
- ② Starting T_J = 25°C, L = 0.130mH
R_G = 25Ω, I_{AS} = 82A. (See Figure 12).
- ③ I_{SD} ≤ 82A, di/dt ≤ 310A/μs, V_{DD} ≤ V_{(BR)DSS},
T_J ≤ 175°C
- ④ Pulse width ≤ 400μs; duty cycle ≤ 2%.

- ⑤ C_{oss eff.} is a fixed capacitance that gives the same charging time as C_{oss} while V_{DS} is rising from 0 to 80% V_{DSS}.
 - ⑥ Calculated continuous current based on maximum allowable junction temperature. Package limitation current is 75A.
 - ⑦ Limited by T_{Jmax}, see Fig.12a, 12b, 15, 16 for typical repetitive avalanche performance.
- ** When mounted on 1" square PCB (FR-4 or G-10 Material).
For recommended footprint and soldering techniques refer to application note #AN-994.

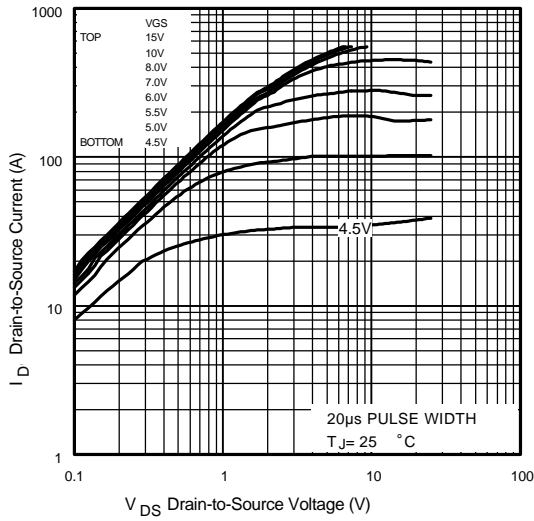

Fig 1. Typical Output Characteristics

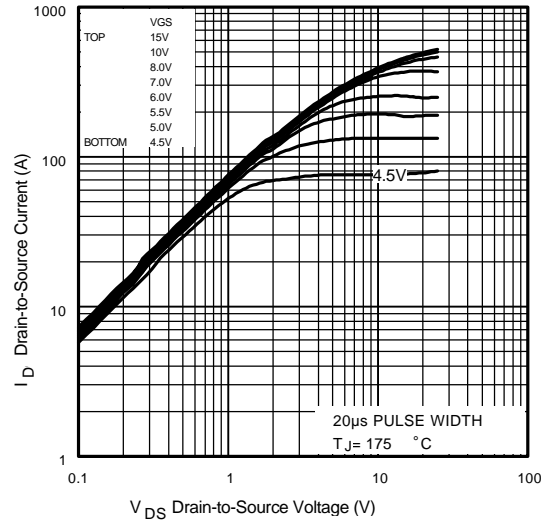

Fig 2. Typical Output Characteristics

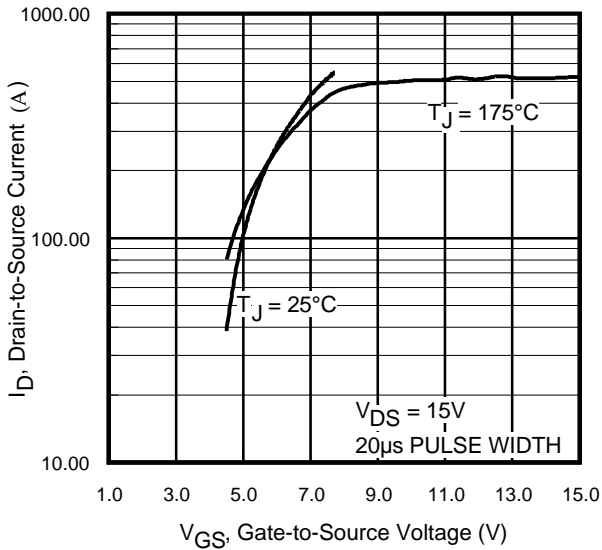

Fig 3. Typical Transfer Characteristics

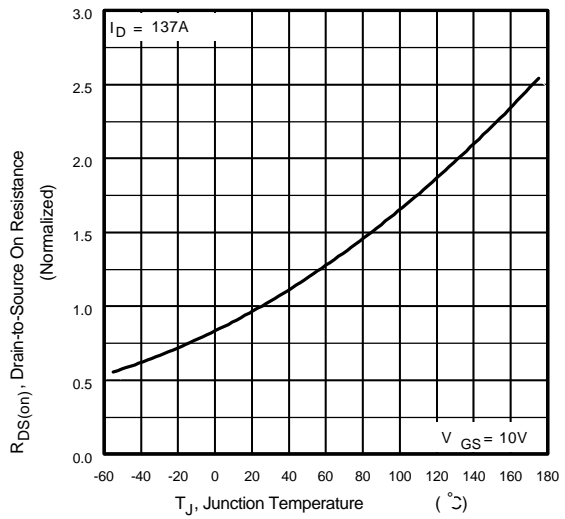

Fig 4. Normalized On-Resistance Vs. Temperature

IRF3808S/IRF3808L

International
IR Rectifier

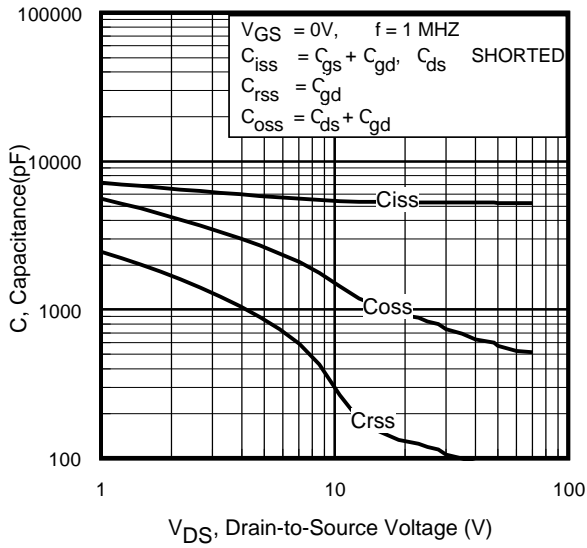

Fig 5. Typical Capacitance Vs. Drain-to-Source Voltage

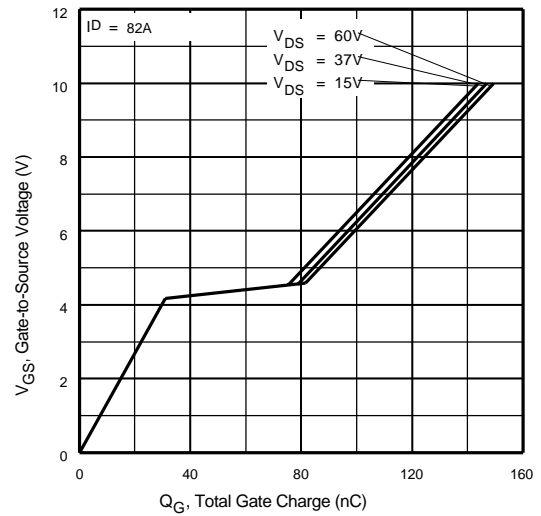

Fig 6. Typical Gate Charge Vs. Gate-to-Source Voltage

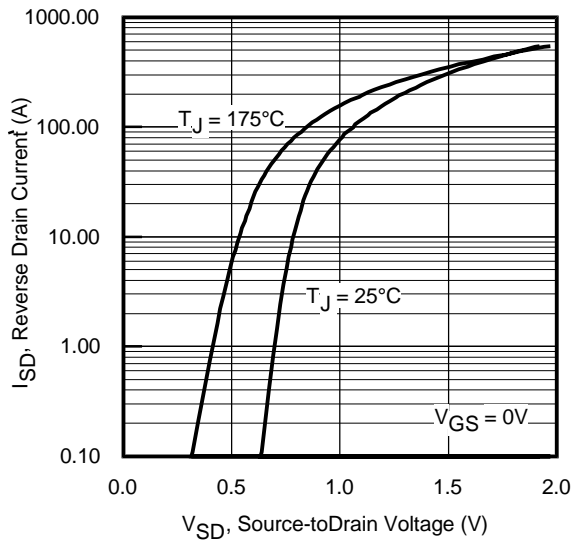

Fig 7. Typical Source-Drain Diode Forward Voltage

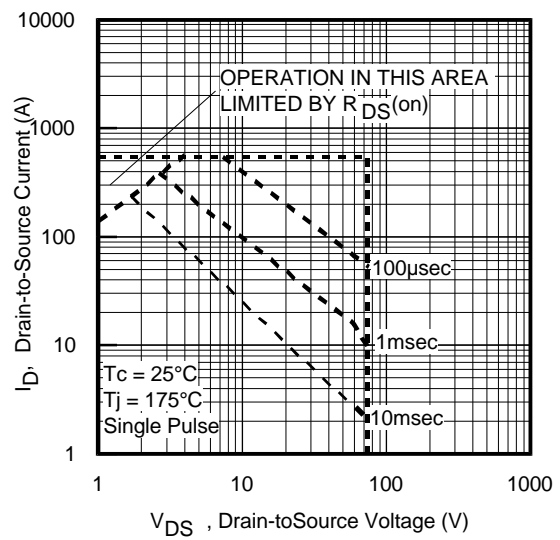

Fig 8. Maximum Safe Operating Area

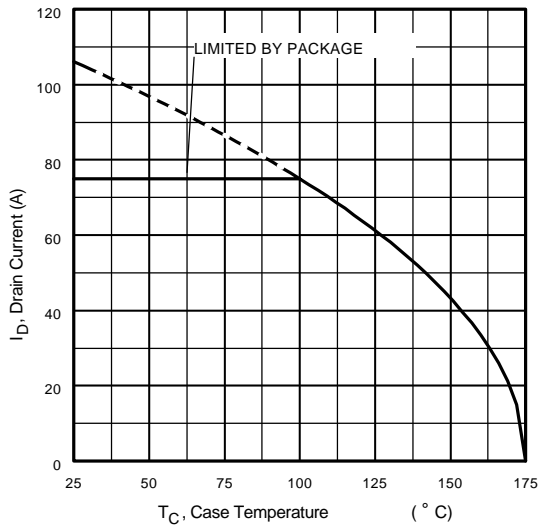

Fig 9. Maximum Drain Current Vs. Case Temperature

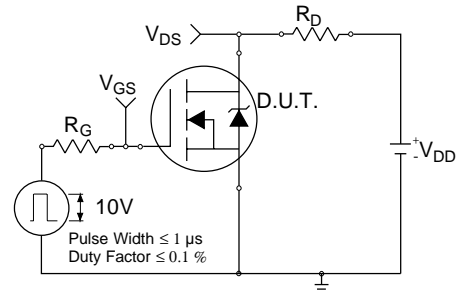

Fig 10a. Switching Time Test Circuit



Fig 10b. Switching Time Waveforms

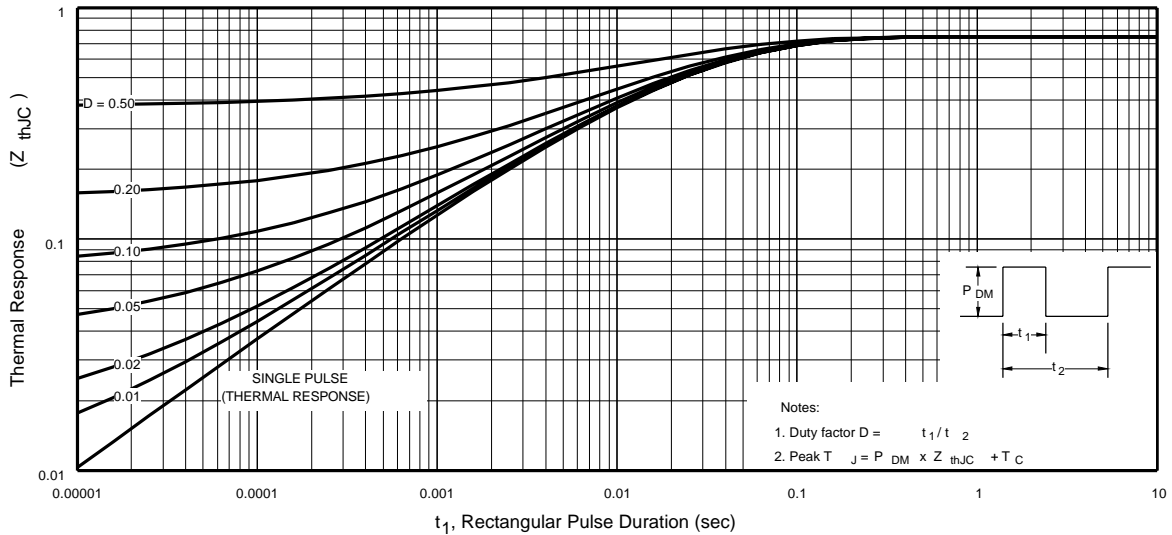

Fig 11. Maximum Effective Transient Thermal Impedance, Junction-to-Case

IRF3808S/IRF3808L

International
IR Rectifier

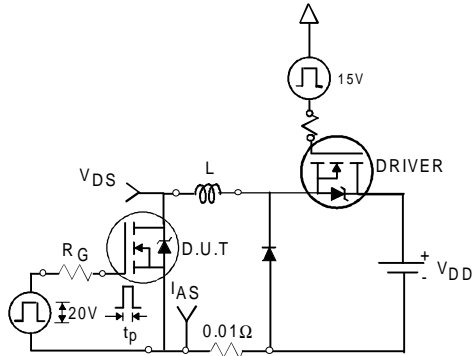

Fig 12a. Unclamped Inductive Test Circuit



Fig 12b. Unclamped Inductive Waveforms

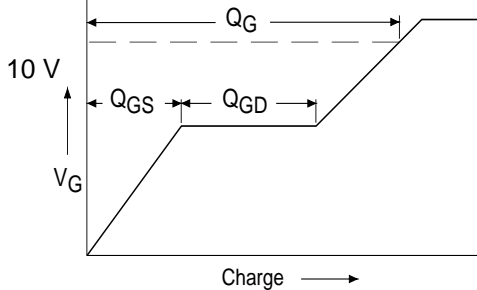

Fig 13a. Basic Gate Charge Waveform



Fig 13b. Gate Charge Test Circuit

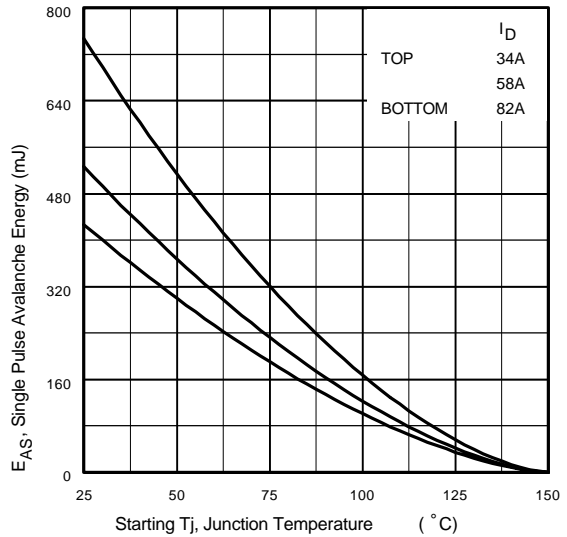

Fig 12c. Maximum Avalanche Energy Vs. Drain Current

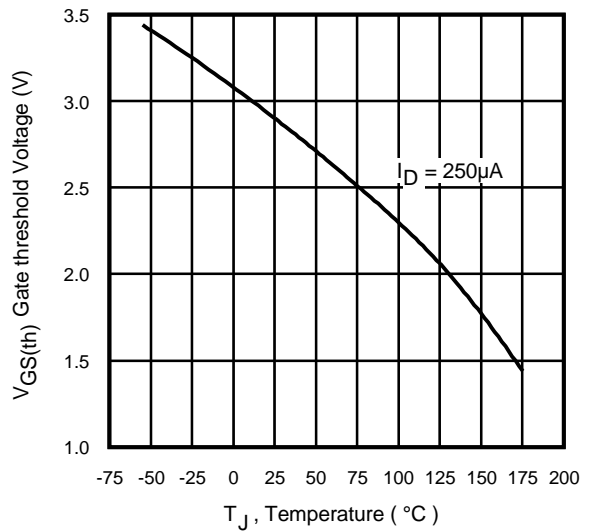

Fig 14. Threshold Voltage Vs. Temperature

www.irf.com

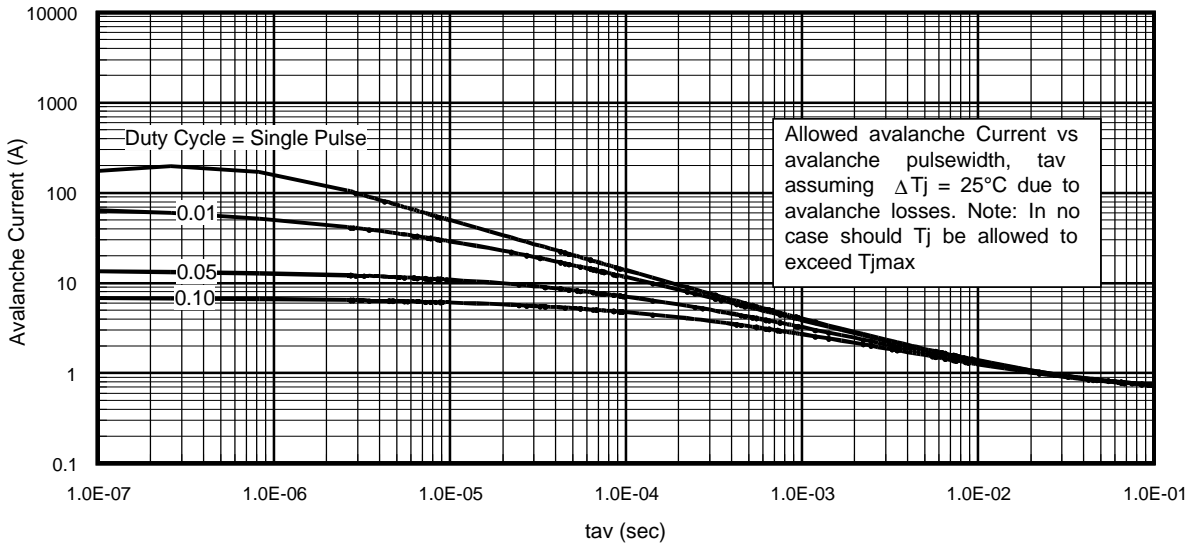

Fig 15. Typical Avalanche Current Vs.Pulsewidth

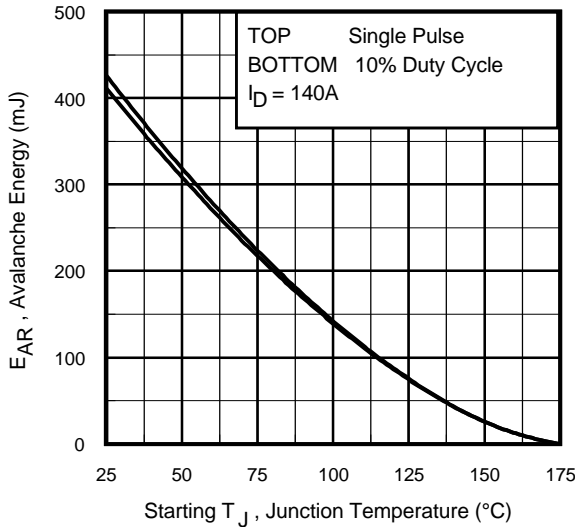

Fig 16. Maximum Avalanche Energy Vs. Temperature

**Notes on Repetitive Avalanche Curves , Figures 15, 16:
(For further info, see AN-1005 at www.irf.com)**

1. Avalanche failures assumption:
Purely a thermal phenomenon and failure occurs at a temperature far in excess of T_{jmax} . This is validated for every part type.
2. Safe operation in Avalanche is allowed as long as T_{jmax} is not exceeded.
3. Equation below based on circuit and waveforms shown in Figures 12a, 12b.
4. $P_{D(ave)}$ = Average power dissipation per single avalanche pulse.
5. BV = Rated breakdown voltage (1.3 factor accounts for voltage increase during avalanche).
6. I_{av} = Allowable avalanche current.
7. ΔT = Allowable rise in junction temperature, not to exceed T_{jmax} (assumed as 25°C in Figure 15, 16).
 t_{av} = Average time in avalanche.
 D = Duty cycle in avalanche = $t_{av} \cdot f$
 $Z_{thJC}(D, t_{av})$ = Transient thermal resistance, see figure 11)

$$P_{D(ave)} = 1/2 (1.3 \cdot BV \cdot I_{av}) = \Delta T / Z_{thJC}$$

$$I_{av} = 2 \Delta T / [1.3 \cdot BV \cdot Z_{th}]$$

$$E_{AS(AR)} = P_{D(ave)} \cdot t_{av}$$

Peak Diode Recovery dv/dt Test Circuit

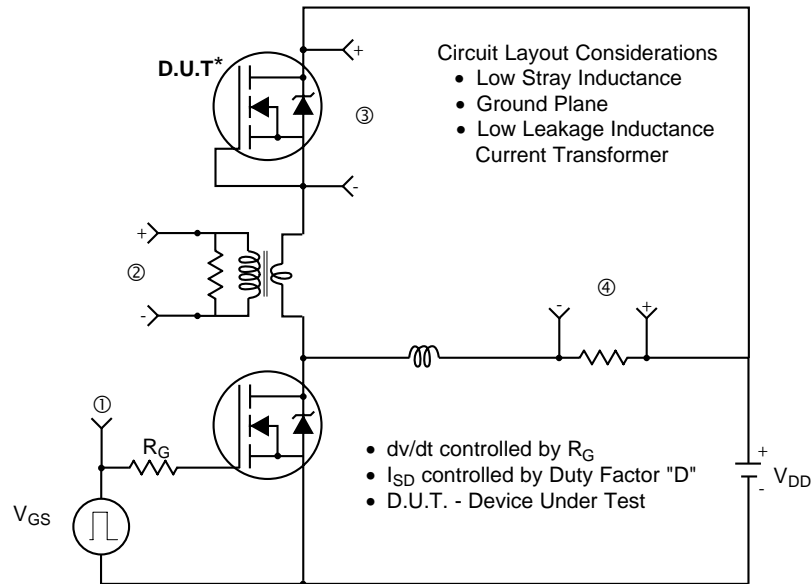

* Reverse Polarity of D.U.T for P-Channel

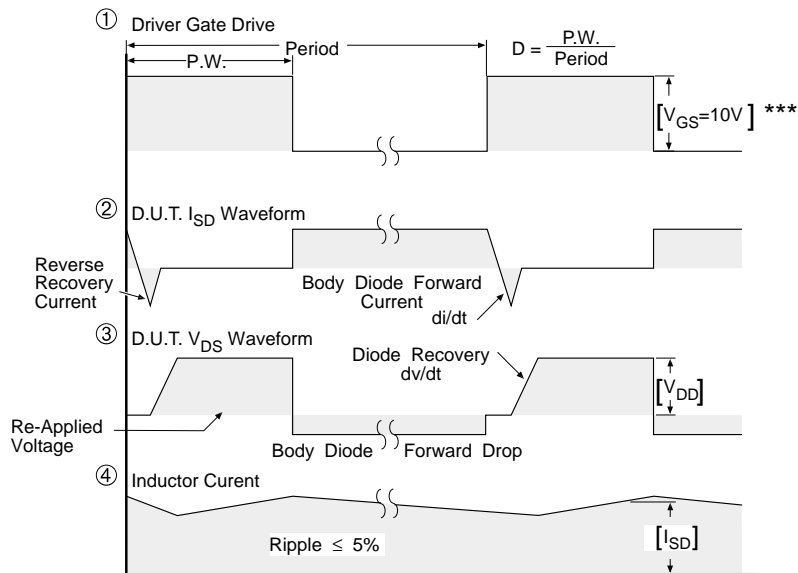

*** $V_{GS} = 5.0V$ for Logic Level and 3V Drive Devices

Fig 17. For N-channel HEXFET® power MOSFETs

D²Pak Package Outline

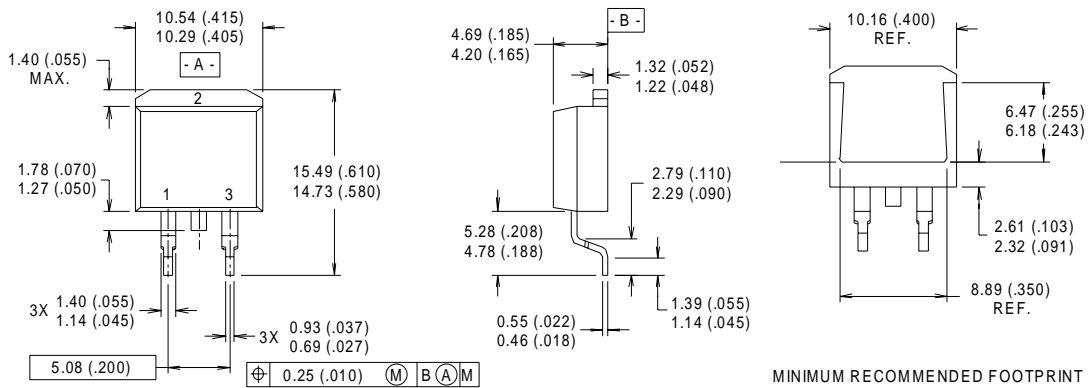

NOTES:

- 1 DIMENSIONS AFTER SOLDER DIP.
- 2 DIMENSIONING & TOLERANCING PER ANS Y14.5M, 1982.
- 3 CONTROLLING DIMENSION : INCH.
- 4 HEATSINK & LEAD DIMENSIONS DO NOT INCLUDE BURRS.

LEAD ASSIGNMENTS

- 1 - GATE
- 2 - DRAIN
- 3 - SOURCE

MINIMUM RECOMMENDED FOOTPRINT

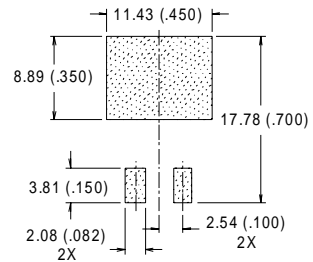

D²Pak Part Marking Information

EXAMPLE: THIS IS AN IRF530S WITH
 LOT CODE 8024
 ASSEMBLED ON WW02, 2000
 IN THE ASSEMBLY LINE "L"

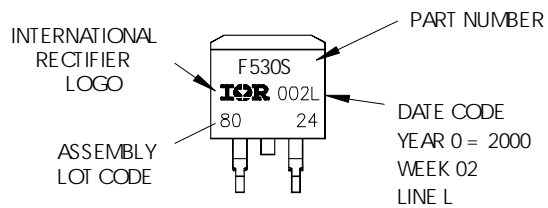

IRF3808S/IRF3808L

International
IR Rectifier

TO-262 Package Outline

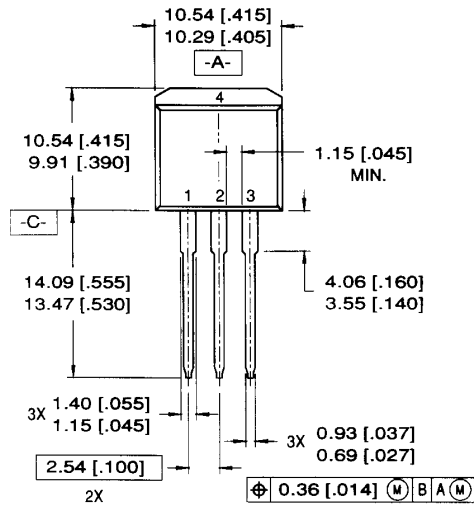

LEAD ASSIGNMENTS
 1 = GATE 3 = SOURCE
 2 = DRAIN 4 = DRAIN

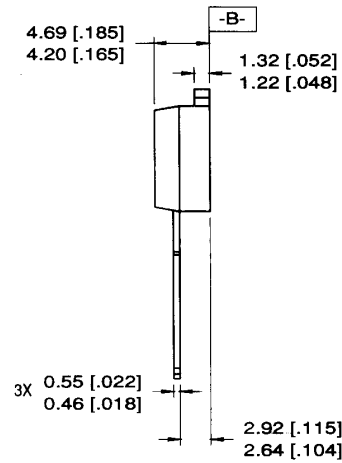

NOTES:

1. DIMENSIONING & TOLERANCING PER ANSI Y14.5M-1982
2. CONTROLLING DIMENSION: INCH.
3. DIMENSIONS ARE SHOWN IN MILLIMETERS [INCHES].
4. HEATSINK & LEAD DIMENSIONS DO NOT INCLUDE BURRS.

TO-262 Part Marking Information

EXAMPLE: THIS IS AN IRL3103L
 LOT CODE 1789
 ASSEMBLED ON WW19, 1997
 IN THE ASSEMBLY LINE "C"

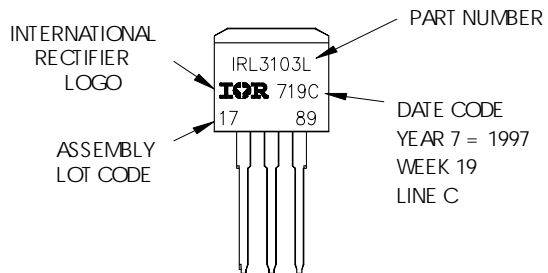

D²Pak Tape & Reel Information

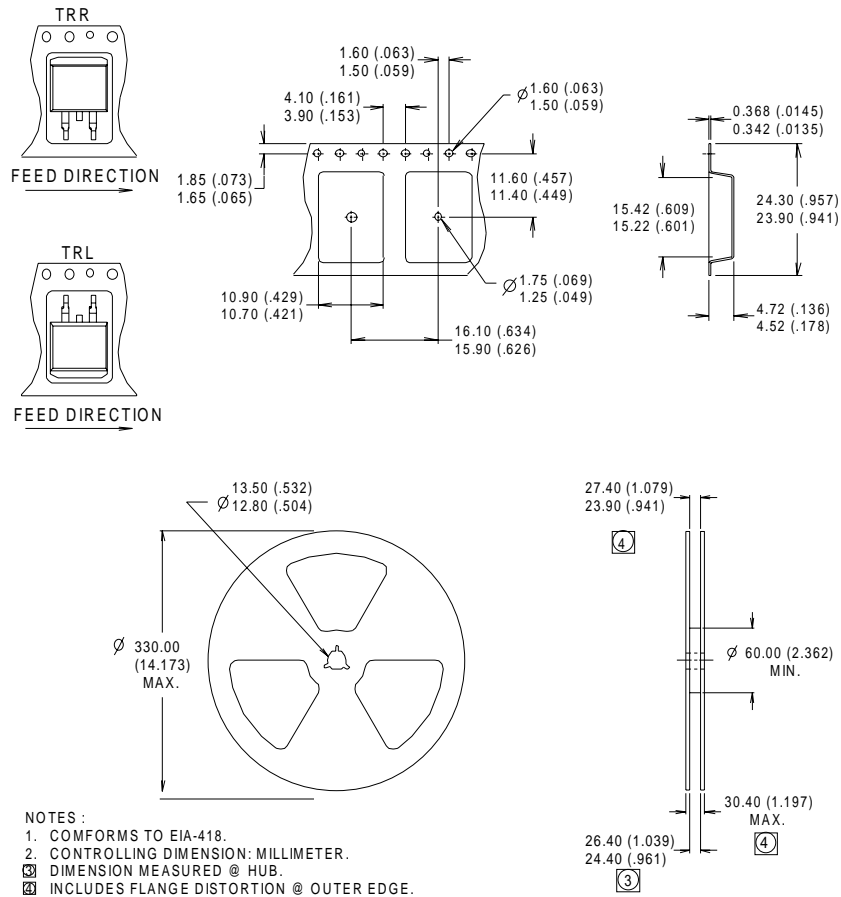

Data and specifications subject to change without notice.
 This product has been designed and qualified for the Industrial market.
 Qualification Standards can be found on IR's Web site.

Note: For the most current drawings please refer to the IR website at:
<http://www.irf.com/package/>