

ROHM GROUP

Best Selection of General-purpose ICs

Ver.2.0



General Purpose IC Family

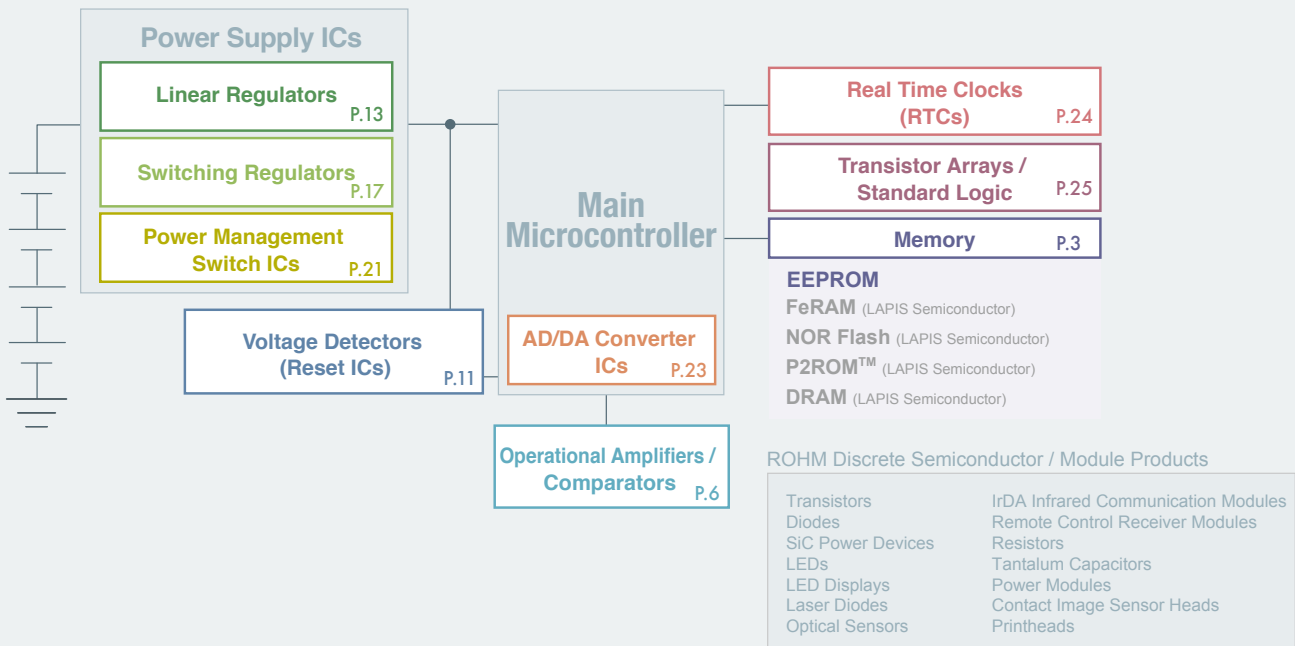

Memory

The ROHM Group offers a broad range of memory products, from EEPROM, FeRAM, and P2ROM™ to NOR Flash, DRAM, and more. EEPROMs are a type of rewriteable non-volatile memory that offer superior access for small-scale units, making them ideal for storing initial data, manufacturing control numbers, and/or status information.

Operational Amplifiers / Comparators

Analog circuits are utilized in a number of applications that require amplification of ultra-small signals received from sensors. ROHM's family of operational amplifiers and comparators includes bipolar and CMOS types optimized for a variety of applications, from general-purpose to automotive-grade requiring ultra-high reliability.

Voltage Detectors (Reset ICs)

ROHM voltage detectors (Reset ICs) monitors the power supply voltage to prevent system errors and ensure stable operation required for MCUs and other applications.

Linear Regulators

A wide lineup of linear regulators is available, such as ultra-compact CMOS LDOs optimized for portable devices and high voltage LDOs that provide automotive-grade reliability, allowing users to select the ideal solution based on application requirements.

Switching Regulators

ROHM buck DC/DC switching converters utilize a high efficiency design ideal for input voltage rails. A number of features are provided, including current mode control, fixed ON time, and H³Reg™ control, ensuring compatibility with a variety of set needs.

Power Management Switch ICs

Our power management switch series integrate a low ON-resistance MOSFET switch and multiple protection circuits on a single chip. This minimizes loss for greater efficiency and makes it possible to achieve a more stable system design in a compact form factor.

AD/DA Converter ICs

ROHM data converters are available in a variety of resolutions, interfaces, and channels. AEC-Q100-compliant products designed for automotive applications are available as well.

Real Time Clocks (RTCs)

Real Time Clocks (RTCs) are ICs that provide both clock and calendar functions, and are designed to continue to operate even when the main power supply is down through a backup power source such as secondary battery. ROHM RTCs are compact, feature low power consumption, and communicate with host devices through a serial interface. They are compatible with all applications requiring clock functionality, including AV systems, communication devices, OA equipment, PCs, home appliances, and meters.

Transistor Arrays / Standard Logic

Transistor Arrays

ROHM transistor arrays are monolithic ICs that integrate 7 Darlington NPN transistors on a single chip. A clamp diode is also included for output surge absorption.

Standard Logic ICs

ROHM offers a wide variety of logic circuits, from analog switches and shift registers to logic gates and multiplexers, allowing users to select the ideal solution to fit set needs.

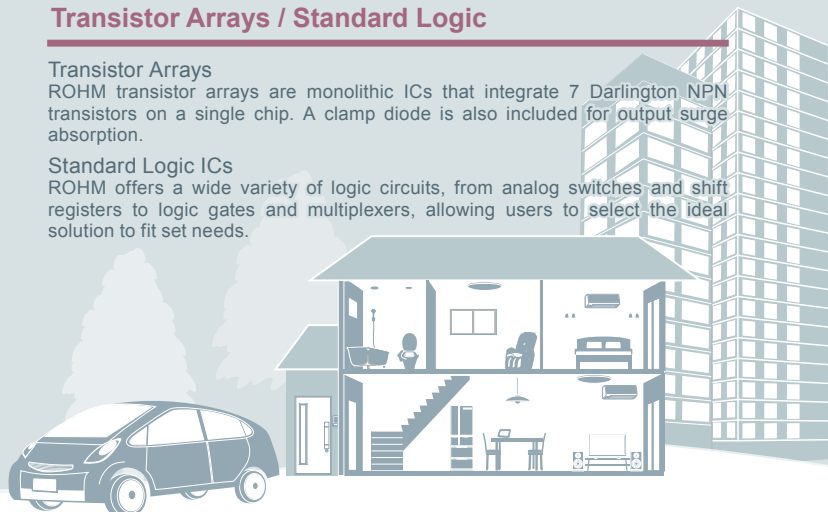
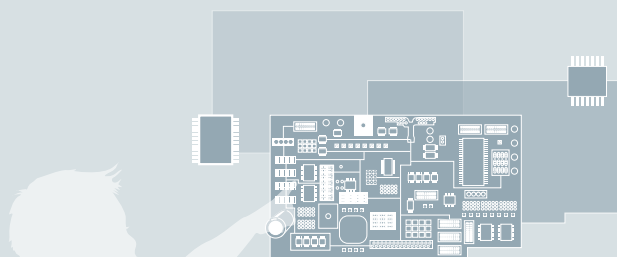



ROHM GROUP

Best Selection of General-purpose ICs

INDEX

Serial EEPROM	P.3
Operational Amplifiers / Comparators	P.6
Voltage Detectors (Reset ICs)	P.11
1ch Linear Regulators	P.13
Switching Regulators	P.17
Power Management Switch ICs	P.21
AD/DA Converter ICs	P.23
Real Time Clocks(RTCs) BU9873 Series	P.24
Transistor Arrays / Standard Logic	P.25
IC Packages	P.26

Serial EEPROMs

Non-Volatile Memory

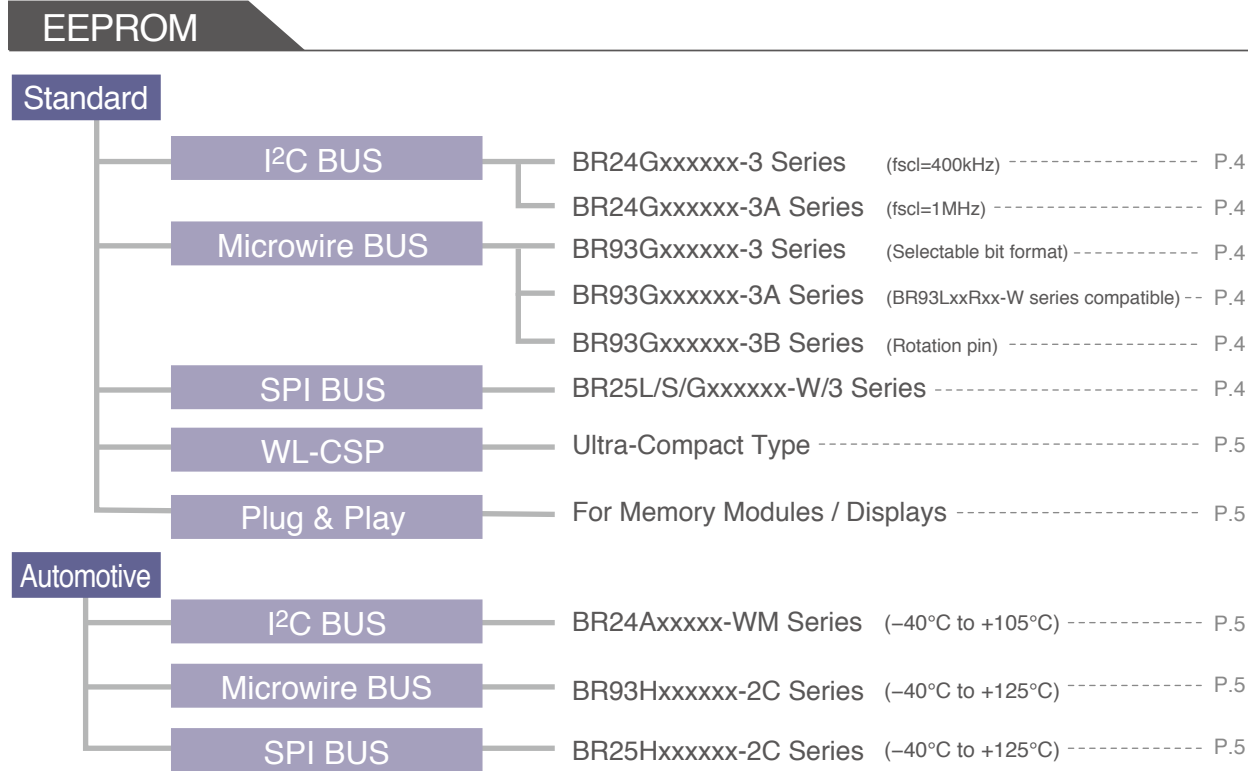

LAPIS Semiconductor

FeRAM

LAPIS Semiconductor

NOR Flash

LAPIS Semiconductor

P2ROM™

Please visit our website for more information on FeRAM and/or NOR Flash

Please refer to our website or LAPIS Semiconductor's Selection Catalog (Non-Volatile Memory P2ROM™ Series) for more information on P2ROM™

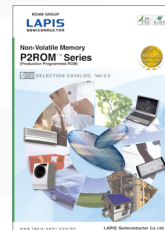

P2ROM™ Series Selection Catalog

Volatile Memory

LAPIS Semiconductor

DRAM



Please refer to our website or LAPIS Semiconductor's Selection Catalog (High Reliability DRAM Series) for more information on our DRAM products

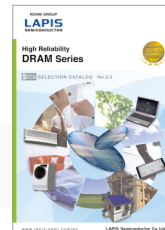

DRAM Series Selection Catalog

Key Features

- Compatible with I²C, Microwire, and SPI BUS I/F
- Available from 1Kbit to 1Mbit
- Broad package lineup, from standard types to ultra-compact WL-CSP (Wafer Level Chip Scale Package)
- AEC-Q100 compliant (automotive-grade)

EEPROM

Standard

Density [Kbit]	Part No. / Package					
	DIP-T8	SOP8	SOP-J8	TSSOP-B8	MSOP8	VSON008X2030
I²C BUS BR24Gxxxxx-3 Series (fscI=400kHz -40°C to +85°C)						
1	BR24G01-3	BR24G01F-3	BR24G01FJ-3	BR24G01FVT-3	BR24G01FVM-3	BR24G01NUX-3
2	BR24G02-3	BR24G02F-3	BR24G02FJ-3	BR24G02FVT-3	BR24G02FVM-3	BR24G02NUX-3
4	BR24G04-3	BR24G04F-3	BR24G04FJ-3	BR24G04FVT-3	BR24G04FVM-3	BR24G04NUX-3
8	BR24G08-3	BR24G08F-3	BR24G08FJ-3	BR24G08FVT-3	BR24G08FVM-3	BR24G08NUX-3
16	BR24G16-3	BR24G16F-3	BR24G16FJ-3	BR24G16FVT-3	BR24G16FVM-3	BR24G16NUX-3
32	BR24G32-3	BR24G32F-3	BR24G32FJ-3	BR24G32FVT-3	BR24G32FVM-3	BR24G32NUX-3
64	BR24G64-3	BR24G64F-3	BR24G64FJ-3	BR24G64FVT-3	BR24G64FVM-3	BR24G64NUX-3
128	BR24G128-3	BR24G128F-3	BR24G128FJ-3	BR24G128FVT-3	BR24G128FVM-3	BR24G128NUX-3
256	BR24G256-3	BR24G256F-3	BR24G256FJ-3	BR24G256FVT-3	-	-
I²C BUS BR24Gxxxxx-3A Series (fscI=1MHz -40°C to +85°C)						
1	BR24G01-3A	BR24G01F-3A	BR24G01FJ-3A	BR24G01FVT-3A	BR24G01FVM-3A	BR24G01NUX-3A
2	BR24G02-3A	BR24G02F-3A	BR24G02FJ-3A	BR24G02FVT-3A	BR24G02FVM-3A	BR24G02NUX-3A
4	BR24G04-3A	BR24G04F-3A	BR24G04FJ-3A	BR24G04FVT-3A	BR24G04FVM-3A	BR24G04NUX-3A
8	BR24G08-3A	BR24G08F-3A	BR24G08FJ-3A	BR24G08FVT-3A	BR24G08FVM-3A	BR24G08NUX-3A
16	BR24G16-3A	BR24G16F-3A	BR24G16FJ-3A	BR24G16FVT-3A	BR24G16FVM-3A	BR24G16NUX-3A
32	BR24G32-3A	BR24G32F-3A	BR24G32FJ-3A	BR24G32FVT-3A	BR24G32FVM-3A	BR24G32NUX-3A
64	BR24G64-3A	BR24G64F-3A	BR24G64FJ-3A	BR24G64FVT-3A	BR24G64FVM-3A	BR24G64NUX-3A
128	BR24G128-3A	BR24G128F-3A	BR24G128FJ-3A	BR24G128FVT-3A	BR24G128FVM-3A	BR24G128NUX-3A
256	BR24G256-3A	BR24G256F-3A	BR24G256FJ-3A	BR24G256FVT-3A	-	-
512	BR24G512-3A	BR24G512F-3A	BR24G512FJ-3A	BR24G512FVT-3A	-	-
1M	BR24G1M-3A	BR24G1MF-3A	BR24G1MFJ-3A	-	-	-

Density [Kbit]	Part No. / Package					
	DIP-T8	SOP8	SOP-J8	TSSOP-B8	MSOP8	VSON008X2030
Microwire BUS BR93Gxxxxx-3 Series (-40°C to +85°C) < Selectable bit format 8bit or 16bit >						
1	BR93G46-3	BR93G46F-3	BR93G46FJ-3	BR93G46FVT-3	BR93G46FVM-3	BR93G46NUX-3
2	BR93G56-3	BR93G56F-3	BR93G56FJ-3	BR93G56FVT-3	BR93G56FVM-3	BR93G56NUX-3
4	BR93G66-3	BR93G66F-3	BR93G66FJ-3	BR93G66FVT-3	BR93G66FVM-3	BR93G66NUX-3
8	BR93G76-3	BR93G76F-3	BR93G76FJ-3	BR93G76FVT-3	BR93G76FVM-3	BR93G76NUX-3
16	BR93G86-3	BR93G86F-3	BR93G86FJ-3	BR93G86FVT-3	BR93G86FVM-3	BR93G86NUX-3
Microwire BUS BR93Gxxxxx-3A Series (-40°C to +85°C) < BR93LxxRxx-W series compatible >						
1	BR93G46-3A	BR93G46F-3A	BR93G46FJ-3A	BR93G46FVT-3A	BR93G46FVM-3A	BR93G46NUX-3A
2	BR93G56-3A	BR93G56F-3A	BR93G56FJ-3A	BR93G56FVT-3A	BR93G56FVM-3A	BR93G56NUX-3A
4	BR93G66-3A	BR93G66F-3A	BR93G66FJ-3A	BR93G66FVT-3A	BR93G66FVM-3A	BR93G66NUX-3A
8	BR93G76-3A	BR93G76F-3A	BR93G76FJ-3A	BR93G76FVT-3A	BR93G76FVM-3A	BR93G76NUX-3A
16	BR93G86-3A	BR93G86F-3A	BR93G86FJ-3A	BR93G86FVT-3A	BR93G86FVM-3A	BR93G86NUX-3A
Microwire BUS BR93Gxxxxx-3B Series (-40°C to +85°C) < Rotation pin >						
1	BR93G46-3B	BR93G46F-3B	BR93G46FJ-3B	BR93G46FVT-3B	BR93G46FVM-3B	BR93G46NUX-3B
2	BR93G56-3B	BR93G56F-3B	BR93G56FJ-3B	BR93G56FVT-3B	BR93G56FVM-3B	BR93G56NUX-3B
4	BR93G66-3B	BR93G66F-3B	BR93G66FJ-3B	BR93G66FVT-3B	BR93G66FVM-3B	BR93G66NUX-3B
8	BR93G76-3B	BR93G76F-3B	BR93G76FJ-3B	BR93G76FVT-3B	BR93G76FVM-3B	BR93G76NUX-3B
16	BR93G86-3B	BR93G86F-3B	BR93G86FJ-3B	BR93G86FVT-3B	BR93G86FVM-3B	BR93G86NUX-3B

Microwire Pin Assignment



Selectable bit format (8bit or 16bit)



BR93LxxRxx-W series compatible



Rotation pin

Density [Kbit]	Part No. / Package				
	SOP8	SOP-J8	TSSOP-B8	MSOP8	VSON008X2030
SPI BUS BR25L/S/Gxxxxx-W/3 Series (-40°C to +85°C)					
1	BR25L010F-W	BR25L010FJ-W	BR25L010FVT-W	BR25L010FVM-W	-
2	BR25L020F-W	BR25L020FJ-W	BR25L020FVT-W	BR25L020FVM-W	-
4	BR25L040F-W	BR25L040FJ-W	BR25L040FVT-W	BR25L040FVM-W	-
8	BR25L080F-W	BR25L080FJ-W	BR25L080FVT-W	-	-
16	BR25L160F-W	BR25L160FJ-W	BR25L160FVT-W	-	-
32	BR25S320F-W	BR25S320FJ-W	BR25S320FVT-W	BR25S320FVM-W	BR25S320NUX-W
64	BR25S640F-W	BR25S640FJ-W	BR25S640FVT-W	BR25S640FVM-W	-
128	BR25G128F-3	BR25G128FJ-3	BR25G128FVT-3	BR25G128FVM-3	BR25G128NUX-3
256	BR25G256F-3	BR25G256FJ-3	BR25G256FVT-3	-	-

New

New

WL-CSP											Ultra-compact package series												
I/F	Density [Kbit]	Part No.	PKG. Drawing	Size [mm]			Solder ball [mm]		Back Coat Resin	Pull-up resistor	I/F	Density [Kbit]	Part No.	PKG. Drawing	Size [mm]			Solder ball [mm]		Back Coat Resin	Pull-up resistor		
				X (Typ.)	Y (Typ.)	Height (Max.)	φ	Pitch							X (Typ.)	Y (Typ.)	Height (Max.)	φ	Pitch				
I ² C	2	BU9833GUL-W		1.27	1.50	0.55	0.25	0.5	○	-	I ² C	64	BRCG064GWZ-3		1.50	1.00	0.36	0.20	0.4	○	-		
	4	BU9847GUL-W		1.95	1.06	0.55	0.25	0.5	○	-			BRCB064GWZ-3		1.50	1.00	0.35	0.20	0.4	-	WP		
	8	BU9889GUL-W		1.60	1.00	0.55	0.25	0.5	○	-			BRCE064GWZ-3		1.50	1.00	0.30	0.20	0.4	-	-		
		BRCB008GWZ-3		0.94	0.94	0.33	0.20	0.4	-	-	128	BU9897GUL-W		2.44	1.99	0.55	0.25	0.5	○	-			
	16	BRCB016GWL-3		1.10	1.15	0.55	0.25	0.4	-	-		SPI	8	BU9832GUL-W		2.09	1.85	0.55	0.25	0.5	○	-	
		BRCB016GWZ-3		1.30	0.77	0.40	0.20	0.4	○	-				16	BU9829GUL-W		1.74	1.65	0.55	0.25	0.5	○	-
		BRCA016GWZ-W		1.30	0.77	0.35	0.20	0.4	-	-					128	BR25S128GUZ-W		2.00	2.63	0.40	0.25	0.5	○
	BRCB016GWX-3		1.30	0.77	0.20	None	0.4	-	WP	MW	4	BU9891GUL-W		1.60		1.00	0.55	0.25	0.5	○	-		
	32	BRCB032GWZ-3		1.45	0.77	0.33	0.20	0.4	-			-											

Plug & Play						
Part No.	Application	I/F	Density [Kbit]	Supply Voltage (V)	Function	Package
BR34L02FVT-W	Memory Modules	I ² C	2	1.7 to 5.5	One time ROM write protect	TSSOP-B8
BR34E02/FVT-3/NUX-3	Memory Modules	I ² C	2	1.7 to 5.5	Settable write protect Onetime ROM write protect	TSSOP-B8/VSON008X2030
BR24C21/F/FJ/FV	Displays	-	1	2.5 to 5.5	DDC1™/DDC2™	SOP8/SOP-J8/SSOP-B8
BU9882/F-W/FV-W	Displays	-	1x2ch	2.5 to 5.5	Dual port DDC2™	SOP14/SSOP-B14
BU9883FV-W	Displays	I ² C	2x3ch	3.0 to 5.5	3port for HDMI EDID memory	SSOP-B16
BU99022NUX-3	Panel etc.	I ² C	2x2ch	1.7 to 5.5	Dual port	VSON008X2030

Automotive

(AEC-Q100 compliant)

I ² C BUS		BR24Axxxx-WM Series (-40°C to +105°C)			
Density [Kbit]	Part No. / Package	SOP8			
		SOP8	SOP-J8	TSSOP-B8	MSOP8
1	BR24A01AF-WM	BR24A01AFJ-WM	-	-	
2	BR24A02F-WM	BR24A02FJ-WM	-	BR24A02FVM-WM	
4	BR24A04F-WM	BR24A04FJ-WM	-	-	
8	BR24A08F-WM	BR24A08FJ-WM	-	-	
16	BR24A16F-WM	BR24A16FJ-WM	-	-	
32	BR24A32F-WM	-	-	-	
64	BR24A64F-WM	-	-	-	

Microwire BUS		BR93Hxxxxx-2C Series (-40°C to +125°C)			
Density [Kbit]	Part No. / Package	SOP8			
		SOP8	SOP-J8	TSSOP-B8	MSOP8
1	BR93H46RF-2C	BR93H46RFJ-2C	BR93H46RFVT-2C	BR93H46RFVM-2C	
2	BR93H56RF-2C	BR93H56RFJ-2C	BR93H56RFVT-2C	BR93H56RFVM-2C	
4	BR93H66RF-2C	BR93H66RFJ-2C	BR93H66RFVT-2C	BR93H66RFVM-2C	
8	BR93H76RF-2C	BR93H76RFJ-2C	BR93H76RFVT-2C	BR93H76RFVM-2C	
16	BR93H86RF-2C	BR93H86RFJ-2C	BR93H86RFVT-2C	BR93H86RFVM-2C	

SPI BUS		BR25Hxxxxx-2C Series (-40°C to +125°C)			
Density [Kbit]	Part No. / Package	SOP8			
		SOP8	SOP-J8	TSSOP-B8	MSOP8
1	BR25H010F-2C	BR25H010FJ-2C	BR25H010FVT-2C	BR25H010FVM-2C	
2	BR25H020F-2C	BR25H020FJ-2C	BR25H020FVT-2C	BR25H020FVM-2C	
4	BR25H040F-2C	BR25H040FJ-2C	BR25H040FVT-2C	BR25H040FVM-2C	
8	BR25H080F-2C	BR25H080FJ-2C	BR25H080FVT-2C	BR25H080FVM-2C	
16	BR25H160F-2C	BR25H160FJ-2C	BR25H160FVT-2C	BR25H160FVM-2C	
32	BR25H320F-2C	BR25H320FJ-2C	BR25H320FVT-2C	BR25H320FVM-2C	
64	BR25H640F-2C	BR25H640FJ-2C	BR25H640FVT-2C	-	
128	BR25H128F-2C	BR25H128FJ-2C	-	-	

Operational Amplifiers / Comparators

Operational Amplifiers / Comparators

Operational Amplifiers

Standard	Ground Sense Operational Amplifiers -----	P.7
High Speed	Input-Output Full Swing Operational Amplifiers -----	P.7
	Ground Sense Operational Amplifiers -----	P.7
Low Power Consumption	Input-Output Full Swing Operational Amplifiers -----	P.8
	Ground Sense Operational Amplifiers -----	P.8
Low Noise	Output Full Swing Operational Amplifiers -----	P.8
	Dual Supply Voltage Operational Amplifiers -----	P.8
Low Offset Voltage	Ground Sense Operational Amplifiers -----	P.9
	Dual Supply Voltage Operational Amplifiers -----	P.9
	Input-Output Full Swing Operational Amplifiers -----	P.9

Comparators

Standard	Open-Collector Comparators -----	P.9
High Speed	Push-Pull Comparators -----	P.9
	Open-Drain Comparators -----	P.9
Low Power Consumption	Push-Pull Comparators -----	P.9
	Open-Drain Comparators -----	P.9
Low Offset Voltage	Open-Collector Comparator -----	P.9

Automotive Operational Amplifiers / Comparators

Automotive Operational Amplifiers

Automotive Ground Sense / Automotive Ground Sense / Automotive Low Noise -----	P.10
--------------------------------------------------------------------------------	------

Automotive Comparators

Automotive Open-Collector -----	P.10
---------------------------------	------

New

- Expanded universal series lineup (1-/2-/4-Circuit Designs)
LMR321G/LMR358x/LMR93x/LMR98x/LMR324x/LMR821G/LMR342x
LM4559x/LM4565x/BD1273x
- Expanded automotive-grade lineup
Ground Sense Op Amps: BA2902Yxxx-M (4-circuit)/BA2904Yxxx-M (2-circuit)
Ground Sense Comparators: BA2901Yxx-M (4-circuit)/BA2903Yxxx-M (2-circuit)
Low Noise Op Amps: BA4558Yxxx-M (2-circuit), BA4560Yxxx-M (2-circuit), BA4580Yxxx-M (2-circuit)
- 1.7V low voltage input/output full-swing op amps
High common-mode rejection ratio ideal for a variety of sensor applications (i.e. accelerometers, angular velocity and pressure sensors)
: BD5291G (1-circuit)

Operational Amplifiers

Part No.	CH	Supply Voltage (V)	Circuit current (mA)	Input offset voltage (mV)	Input bias current (nA)	Output current (mA)	Input voltage range (V)	Output voltage range (V)	Voltage gain (dB)	Slew rate (V/μs)	Gain bandwidth product (MHz)	Operating temperature (°C)	Package
Standard		Ground Sense Operational Amplifiers											
BA2904	2	3 to 36	0.5	2.0	20	30	V_{EE} to $V_{CC}-1.5$	V_{EE} to $V_{CC}-1.5$	100	0.2	0.5	-40 to +125	SOP8/SSOP-B8/MSOP8
BA2904S												-40 to +105	
BA2902	4	3 to 36	0.7	2.0	20	30	V_{EE} to $V_{CC}-1.5$	V_{EE} to $V_{CC}-1.5$	100	0.2	0.5	-40 to +125	SOP14/SSOP-B14
BA2902S												-40 to +105	
BA3404	2	4 to 36	2.0	2.0	70	30	V_{EE} to $V_{CC}-2.0$	V_{EE} to $V_{CC}-2.0$	100	1.2	1.2	-40 to +85	SOP8/MSOP8
BA10358	2	3 to 32	0.5	2.0	45	20	V_{EE} to $V_{CC}-1.5$	V_{EE} to $V_{CC}-1.5$	100	0.2	0.5	-40 to +85	SOP8/SSOP-B8/SOP-J8
BA10324A	4	3 to 32	0.6	2.0	20	35	V_{EE} to $V_{CC}-1.5$	V_{EE} to $V_{CC}-1.5$	100	0.2	0.5	-40 to +85	SOP14/SSOP-B14/SOP-J14

Part No.	CH	Supply Voltage (V)	Circuit current (μA)	Input offset voltage (mV)	Input bias current (nA)	Output current (mA)	Input voltage range (V)	Output voltage range (V)	Voltage gain (dB)	Slew rate (V/μs)	Gain bandwidth product (MHz)	Operating temperature (°C)	Package
High Speed		Input-Output Full Swing Operational Amplifiers											
BU7261G	1	1.8 to 5.5	250	1.0	0.001	10	V_{SS} to V_{DD}	$V_{SS}+0.1$ to $V_{DD}-0.1$	95	1.1	2.0	-40 to +85	SSOP5
BU7261SG												-40 to +105	
BU7262	2	1.8 to 5.5	550	1.0	0.001	10	V_{SS} to V_{DD}	$V_{SS}+0.1$ to $V_{DD}-0.1$	95	1.1	2.0	-40 to +85	SOP8/MSOP8/ VSON008X2030
BU7262S												-40 to +105	
BU7264	4	1.8 to 5.5	1100	1.0	0.001	10	V_{SS} to V_{DD}	$V_{SS}+0.1$ to $V_{DD}-0.1$	95	1.1	2.0	-40 to +85	SOP14/SSOP-B14
BU7264S												-40 to +105	
BU7291G	1	2.4 to 5.5	470	1.0	0.001	8	V_{SS} to V_{DD}	$V_{SS}+0.1$ to $V_{DD}-0.1$	105	3.0	2.8	-40 to +85	SSOP5
BU7291SG												-40 to +105	
BU7294	4	2.4 to 5.5	2000	1.0	0.001	8	V_{SS} to V_{DD}	$V_{SS}+0.1$ to $V_{DD}-0.1$	105	3.0	2.8	-40 to +85	SOP14/SSOP-B14
BU7294S												-40 to +105	
BU7295HFV	1	1.8 to 5.5	150	1.0	0.001	8	V_{SS} to V_{DD}	$V_{SS}+0.1$ to $V_{DD}-0.1$	95	1.0	1.0	-40 to +85	HVSOF5
BU7295SHFV												-40 to +105	
BU7255HFV	1	2.4 to 5.5	540	1.0	0.001	4	V_{SS} to V_{DD}	$V_{SS}+0.1$ to $V_{DD}-0.1$	105	3.4	4.0	-40 to +85	HVSOF5
BU7255SHFV												-40 to +105	
BD7561G	1	5 to 14.5	440	1.0	0.001	8	V_{SS} to V_{DD}	$V_{SS}+0.1$ to $V_{DD}-0.1$	95	0.9	1.0	-40 to +85	SSOP5
BD7561SG												-40 to +105	
BD7562	2	5 to 14.5	900	1.0	0.001	8	V_{SS} to V_{DD}	$V_{SS}+0.1$ to $V_{DD}-0.1$	95	0.9	1.0	-40 to +85	SOP8/MSOP8
BD7562S												-40 to +105	

Part No.	CH	Supply Voltage (V)	Circuit current (mA)	Input offset voltage (mV)	Input bias current (nA)	Output current (mA)	Input voltage range (V)	Output voltage range (V)	Voltage gain (dB)	Slew rate (V/μs)	Gain bandwidth product (MHz)	Operating temperature (°C)	Package
High Speed		Ground Sense Operational Amplifiers											
BA3472	2	3 to 36	4.0	1.0	100	30	V_{EE} to $V_{CC}-2.0$	$V_{EE}+0.3$ to $V_{CC}-1.0$	100	10	4.0	-40 to +85	SOP8/SSOP-B8/SOP-J8/ MSOP8/TSSOP-B8
BA3472RFVM												-40 to +105	
BA3474F	4	3 to 36	8.0	1.0	100	30	V_{EE} to $V_{CC}-2.0$	$V_{EE}+0.3$ to $V_{CC}-1.0$	100	10	4.0	-40 to +75	SOP14
BA3474FV/FVJ												-40 to +85	
BA3474RFV	4	3 to 36	8.0	1.0	100	30	V_{EE} to $V_{CC}-2.0$	$V_{EE}+0.3$ to $V_{CC}-1.0$	100	10	4.0	-40 to +105	SSOP-B14/TSSOP-B14J
BA3474RFV												-40 to +105	
BU7461G	1	1.7 to 5.5	0.15	1.0	0.001	8	V_{SS} to $V_{DD}-1.2$	$V_{SS}+0.1$ to $V_{DD}-0.1$	95	1.0	1.0	-40 to +85	SSOP5
BU7461SG												-40 to +105	
BU7462	2	1.7 to 5.5	0.3	1.0	0.001	8	V_{SS} to $V_{DD}-1.2$	$V_{SS}+0.1$ to $V_{DD}-0.1$	95	1.0	1.0	-40 to +85	SOP8/MSOP8/ VSON008X2030
BU7462S												-40 to +105	
BU7464F	4	1.7 to 5.5	0.6	1.0	0.001	8	V_{SS} to $V_{DD}-1.2$	$V_{SS}+0.1$ to $V_{DD}-0.1$	95	1.0	1.0	-40 to +85	SOP14
BU7464SF												-40 to +105	
BU7481G	1	1.8 to 5.5	0.42	1.0	0.001	8	V_{SS} to $V_{DD}-1.2$	$V_{SS}+0.1$ to $V_{DD}-0.1$	105	3.2	2.8	-40 to +85	SSOP5
BU7481SG												-40 to +105	
BU7485G	1	3.0 to 5.5	1.5	1.0	0.001	8	V_{SS} to $V_{DD}-1.4$	$V_{SS}+0.1$ to $V_{DD}-0.1$	105	10	10.0	-40 to +85	SSOP5
BU7485SG												-40 to +105	
BU7486	2	3.0 to 5.5	3.0	1.0	0.001	8	V_{SS} to $V_{DD}-1.4$	$V_{SS}+0.1$ to $V_{DD}-0.1$	105	10	10.0	-40 to +85	SOP8/SSOP-B8/ MSOP8
BU7486S												-40 to +105	
BU7487	4	3.0 to 5.5	6.0	1.0	0.001	8	V_{SS} to $V_{DD}-1.4$	$V_{SS}+0.1$ to $V_{DD}-0.1$	105	10	10.0	-40 to +85	SOP14/SSOP-B14
BU7487S												-40 to +105	
BU7465HFV	1	1.7 to 5.5	0.12	1.0	0.001	8	V_{SS} to $V_{DD}-1.2$	$V_{SS}+0.1$ to $V_{DD}-0.1$	100	1.0	1.2	-40 to +85	HVSOF5
BU7465SHFV												-40 to +105	
BU7495HFV	1	1.8 to 5.5	0.65	1.0	0.001	7	V_{SS} to $V_{DD}-1.2$	$V_{SS}+0.1$ to $V_{DD}-0.1$	100	5.0	4.0	-40 to +85	HVSOF5
BU7495SHFV												-40 to +105	

Access Our Website

ROHM Co., Ltd.

www.rohm.com

Part No.	CH	Supply Voltage (V)	Circuit current (μA)	Input offset voltage (mV)	Input bias current (nA)	Output current (mA)	Input voltage range (V)	Output voltage range (V)	Voltage gain (dB)	Slew rate (V/μs)	Gain bandwidth product (MHz)	Operating temperature (°C)	Package
Low Power Consumption Input-Output Full Swing Operational Amplifiers													
BU7241G	1	1.8 to 5.5	70	1.0	0.001	10	V _{SS} to V _{DD}	V _{SS} +0.1 to V _{DD} -0.1	95	0.4	0.9	-40 to +85	SSOP5
BU7241SG												-40 to +105	
BU7242	2	1.8 to 5.5	180	1.0	0.001	10	V _{SS} to V _{DD}	V _{SS} +0.1 to V _{DD} -0.1	95	0.4	0.9	-40 to +85	SOP8/MSOP8/ VSON008X2030
BU7242S												-40 to +105	
BU7244	4	1.8 to 5.5	360	1.0	0.001	10	V _{SS} to V _{DD}	V _{SS} +0.1 to V _{DD} -0.1	95	0.4	0.9	-40 to +85	SOP14/SSOP-B14
BU7244S												-40 to +105	
BU7271G	1	1.8 to 5.5	8.6	1.0	0.001	4	V _{SS} to V _{DD}	V _{SS} +0.1 to V _{DD} -0.1	100	0.05	0.09	-40 to +85	SSOP5
BU7271SG												-40 to +105	
BU7265G	1	1.8 to 5.5	0.35	1.0	0.001	2.4	V _{SS} to V _{DD}	V _{SS} +0.1 to V _{DD} -0.1	95	0.0024	0.004	-40 to +85	SSOP5
BU7265SG												-40 to +105	
BU7266	2	1.8 to 5.5	0.7	1.0	0.001	2.4	V _{SS} to V _{DD}	V _{SS} +0.1 to V _{DD} -0.1	95	0.0024	0.004	-40 to +85	SOP8/SSOP-B8/ MSOP8
BU7266S												-40 to +105	
BU7275HFV	1	1.8 to 5.5	40	1.0	0.001	8	V _{SS} to V _{DD}	V _{SS} +0.1 to V _{DD} -0.1	95	0.3	0.6	-40 to +85	HVSOF5
BU7275SHFV												-40 to +105	
BU7205HFV	1	1.8 to 5.5	0.4	1.0	0.001	1.2	V _{SS} to V _{DD}	V _{SS} +0.1 to V _{DD} -0.1	95	0.0025	0.0025	-40 to +85	HVSOF5
BU7205SHFV												-40 to +105	
BU7245HFV	1	1.8 to 5.5	5	1.0	0.001	4	V _{SS} to V _{DD}	V _{SS} +0.1 to V _{DD} -0.1	95	0.035	0.09	-40 to +85	HVSOF5
BU7245SHFV												-40 to +105	
BD7541G	1	5 to 14.5	180	1.0	0.001	4	V _{SS} to V _{DD}	V _{SS} +0.1 to V _{DD} -0.1	95	0.3	0.6	-40 to +85	SSOP5
BD7541SG												-40 to +105	
BD7542	2	5 to 14.5	400	1.0	0.001	4	V _{SS} to V _{DD}	V _{SS} +0.1 to V _{DD} -0.1	95	0.3	0.6	-40 to +85	SOP8/MSOP8
BD7542S												-40 to +105	
New BD12730G	1	1.8 to 5.0	320	1.0	50	5	GND to V ₋	0.1 to V ₋ -0.1	85	0.4	1.0	-40 to +85	SSOP5
New BD12732F	2	1.8 to 5.0	580	1.0	50	5	GND to V ₊	0.1 to V ₊ -0.1	85	0.4	1.0	-40 to +85	SOP8
New BD12734F	4	1.8 to 5.0	1200	1.0	50	5	GND to V ₊	0.1 to V ₊ -0.1	85	0.4	1.0	-40 to +85	SOP14
New LMR931G	1	1.8 to 5.0	80	1.0	5	28	V _{SS} to V _{DD}	V _{SS} +0.04 to V _{DD} -0.05	100	0.4	1.4	-40 to +85	SSOP5
New LMR932F	2	1.8 to 5.0	135	1.0	5	28	V _{SS} to V _{DD}	V _{SS} +0.04 to V _{DD} -0.05	100	0.4	1.4	-40 to +85	SOP8
New LMR934F	4	1.8 to 5.0	250	1.0	5	28	V _{SS} to V _{DD}	V _{SS} +0.04 to V _{DD} -0.05	100	0.4	1.4	-40 to +85	SOP14
New LMR981G	1	1.8 to 5.0	80	1.0	5	28	V _{SS} to V _{DD}	V _{SS} +0.04 to V _{DD} -0.05	100	0.4	1.4	-40 to +85	SSOP6
New LMR982FVM	2	1.8 to 5.0	135	1.0	5	28	V _{SS} to V _{DD}	V _{SS} +0.04 to V _{DD} -0.05	100	0.4	1.4	-40 to +85	MSOP10

Low Power Consumption Ground Sense Operational Amplifiers													
BU7441G	1	1.7 to 5.5	50	1.0	0.001	6	V _{SS} to V _{DD} -1.2	V _{SS} +0.1 to V _{DD} -0.1	95	0.3	0.6	-40 to +85	SSOP5
BU7441SG												-40 to +105	
BU7442	2	1.7 to 5.5	100	1.0	0.001	6	V _{SS} to V _{DD} -1.2	V _{SS} +0.1 to V _{DD} -0.1	95	0.3	0.6	-40 to +85	SOP8/MSOP8/ VSON008X2030
BU7442S												-40 to +105	
BU7444F	4	1.7 to 5.5	200	1.0	0.001	6	V _{SS} to V _{DD} -1.2	V _{SS} +0.1 to V _{DD} -0.1	95	0.3	0.6	-40 to +85	SOP14
BU7444SF												-40 to +105	
BU7421G	1	1.7 to 5.5	8.5	1.0	0.001	4	V _{SS} to V _{DD} -1.2	V _{SS} +0.1 to V _{DD} -0.1	100	0.05	0.09	-40 to +85	SSOP5
BU7421SG												-40 to +105	
BU7411G	1	1.6 to 5.5	0.35	1.0	0.001	2.4	V _{SS} to V _{DD} -1.0	V _{SS} +0.1 to V _{DD} -0.1	95	0.0024	0.004	-40 to +85	SSOP5
BU7411SG												-40 to +105	
BU7445HFV	1	1.7 to 5.5	40	1.0	0.001	8	V _{SS} to V _{DD} -1.2	V _{SS} +0.1 to V _{DD} -0.1	100	0.25	0.4	-40 to +85	HVSOF5
BU7445SHFV												-40 to +105	
BU7475HFV	1	1.7 to 5.5	9	1.0	0.001	7	V _{SS} to V _{DD} -1.2	V _{SS} +0.1 to V _{DD} -0.1	100	0.05	0.1	-40 to +85	HVSOF5
BU7475SHFV												-40 to +105	
BD1321G	1	2.7 to 5.5	130	0.1	15	70	V _{EE} to V _{CC} -0.8	V _{EE} +0.08 to V _{CC} -0.04	110	1.0	3.0	-40 to +85	SSOP5
New LMR321G	1	2.7 to 5.5	130	0.1	15	70	V _{EE} to V _{CC} -0.8	V _{EE} +0.08 to V _{CC} -0.04	110	1.0	3.0	-40 to +85	SSOP5
New LMR358	2	2.7 to 5.5	210	0.1	15	70	V _{EE} to V _{CC} -0.8	V _{EE} +0.08 to V _{CC} -0.04	110	1.0	3.0	-40 to +85	SOP8/SOP-18/SSOP-B8/ TSSOP-B8/MSOP8/TSSOP-B8J
New LMR324	4	2.7 to 5.5	410	1.0	15	70	V _{EE} to V _{CC} -0.8	V _{EE} +0.08 to V _{CC} -0.04	110	1.0	3.0	-40 to +85	SOP14/SOP-14/SSOP-B14/ TSSOP-B14J
New LMR821G	1	2.5 to 5.0	220	1.0	30	16	V _{SS} to V _{DD} -0.9	V _{SS} +0.12 to V _{DD} -0.1	100	1.5	4.5	-40 to +85	SSOP5
New LMR342FVJ	2	2.7 to 5.0	200	0.25	0.001	24	V _{SS} to V _{DD} -1.0	V _{SS} +0.06 to V _{DD} -0.06	103	1.0	2.0	-40 to +85	TSSOP-B8J

Part No.	CH	Supply Voltage (V)	Circuit current (mA)	Input offset voltage (mV)	Input bias current (nA)	Input referred noise voltage (μVrms)	Input voltage range (V)	Output voltage range (V)	Voltage gain (dB)	Slew rate (V/μs)	Gain bandwidth product (MHz)	Operating temperature (°C)	Package
Low Noise Output Full Swing Operational Amplifiers													
BA4510	2	±1 to ±3.5	5.0	1.0	80	0.7	V _{EE} +1.5 to V _{CC} -1.5	V _{EE} +0.1 to V _{CC} -0.1	90	5.0	10.0	-20 to +75	SOP8/SSOP-B8/ MSOP8/TSSOP-B8
BA2107G	1	±1 to ±7	1.8	1.0	150	0.9	V _{EE} +1.5 to V _{CC} -1.5	V _{EE} +0.3 to V _{CC} -0.3	80	4.0	12.0	-40 to +85	SSOP5
BA2115	2	±1 to ±7	3.5	1.0	150	0.9	V _{EE} +1.5 to V _{CC} -1.5	V _{EE} +0.3 to V _{CC} -0.3	80	4.0	12.0	-40 to +85	SOP8/SOP-18/MSOP8
Low Noise Dual Supply Voltage Operational Amplifiers													
BA4558	2	±4 to ±15	3.0	0.5	60	1.8	V _{EE} +1.0 to V _{CC} -1.0	V _{EE} +1.0 to V _{CC} -1.0	100	1.0	2.0	-40 to +85	SOP8/SOP-18/SSOP-B8/ MSOP8/TSSOP-B8
BA4558R												-40 to +105	
BA4560	2	±4 to ±15	4.0	0.5	50	1.0	V _{EE} +1.0 to V _{CC} -1.0	V _{EE} +1.0 to V _{CC} -1.0	100	4.0	10.0	-40 to +85	SOP8/SOP-18/SSOP-B8/ MSOP8/TSSOP-B8
BA4560R	2	±4 to ±15	3.0	0.5	50	1.0	V _{EE} +1.0 to V _{CC} -1.0	V _{EE} +1.0 to V _{CC} -1.0	100	4.0	4.0	-40 to +105	SOP8/SOP-18/SSOP-B8/ MSOP8/TSSOP-B8
BA4564RFV	4	±4 to ±15	6.0	0.5	50	1.0	V _{EE} +1.0 to V _{CC} -1.0	V _{EE} +1.0 to V _{CC} -1.0	100	4.0	4.0	-40 to +105	SSOP-B14
BA15218F	2	±2 to ±16	5.0	0.5	50	1.0	V _{EE} +1.0 to V _{CC} -1.0	V _{EE} +2.0 to V _{CC} -2.0	110	3.0	10.0	-40 to +85	SOP8
BA14741	4	±2 to ±18	3.0	1.0	60	2.0	V _{EE} +1.5 to V _{CC} -1.5	V _{EE} +2.5 to V _{CC} -2.5	100	1.0	2.0	-40 to +85	SOP14/SOP-14
BA15532F	2	±3 to ±20	8.0	0.5	200	1.5	V _{EE} +2.0 to V _{CC} -2.0	V _{EE} +2.0 to V _{CC} -2.0	94	8.0	20.0	-20 to +75	SOP8
BA4580R	2	±2 to ±16	6.0	0.3	100	0.8	V _{EE} +1.5 to V _{CC} -1.5	V _{EE} +1.5 to V _{CC} -1.5	110	5.0	5.0	-40 to +105	SOP8/SOP-18/ MSOP8/TSSOP-B8
BA4584FV	4	±2 to ±16	12.0	0.3	100	0.8	V _{EE} +1.5 to V _{CC} -1.5	V _{EE} +1.5 to V _{CC} -1.5	110	5.0	5.0	-40 to +85	SSOP-B14
BA4584R	4	±2 to ±9.5	11.0	0.3	100	0.8	V _{EE} +1.5 to V _{CC} -1.5	V _{EE} +1.5 to V _{CC} -1.5	110	5.0	5.0	-40 to +105	SOP14/SSOP-B14
New LM4559F	2	±4 to ±18	3.3	0.5	40	0.7	V _{EE} +2.0 to V _{CC} -2.0	V _{EE} +1.5 to V _{CC} -1.5	110	3.5	4.0	-40 to +85	SOP8
New LM4565F	2	±4 to ±18	4.5	0.5	70	0.6	V _{EE} +1.0 to V _{CC} -1.0	V _{EE} +1.0 to V _{CC} -1.0	100	5.0	10.0	-40 to +85	SOP8

Part No.	CH	Supply Voltage (V)	Circuit current (mA)	Input offset voltage (mV)	Input bias current (nA)	Output current (mA)	Input voltage range (V)	Output voltage range (V)	Voltage gain (dB)	Slew rate (V/ μ s)	Gain bandwidth product (MHz)	Operating temperature (°C)	Package
Low Offset Voltage		Ground Sense Operational Amplifiers											
BU5281G	1	1.8 to 5.5	0.75	0.1(Typ.)/2.5(Max.)	0.001	8	V_{SS} to $V_{DD}-1.2$	$V_{SS}+0.1$ to $V_{DD}-0.1$	110	2.0	3.0	-40 to +85	SSOP5
BU5281SG												-40 to +105	
BA2904W	2	3 to 36	0.5	0.5(Typ.)/2.0(Max.)	20	30	V_{EE} to $V_{CC}-1.5$	V_{EE} to $V_{CC}-1.5$	100	0.2	0.5	-40 to +125	SOP8/SSOP-B8
Low Offset Voltage		Dual Supply Voltage Operational Amplifiers											
BA4564WV	4	± 4 to ± 15	6.0	0.5(Typ.)/2.5(Max.)	50	25	$V_{EE}+1.0$ to $V_{CC}-1.0$	$V_{EE}+1.0$ to $V_{CC}-1.0$	100	4.0	4.0	-40 to +105	SSOP-B14
BA8522R	2	± 2 to ± 16	5.5	0.1(Typ.)/1.5(Max.)	50	50	$V_{EE}+1.5$ to $V_{CC}-1.5$	$V_{EE}+1.5$ to $V_{CC}-1.5$	110	3.0	6.0	-40 to +105	SOP8/SSOP-B8/MSOP8
Low Offset Voltage		Input-Output Full Swing Operational Amplifiers											
BD5291G	1	1.7 to 5.5	0.65	0.1(Typ.)/2.5(Max.)	0.001	6	V_{SS} to V_{DD}	$V_{SS}+0.1$ to $V_{DD}-0.1$	110	2.5	3.2	-40 to +85	SSOP5

Comparators

Part No.	CH	Supply Voltage (V)	Circuit current (mA)	Input offset voltage (mV)	Input bias current (nA)	Output current (mA)	Input voltage range (V)	Voltage gain (dB)	Response time (μ s)	Operating temperature (°C)	Package
Standard		Open-Collector Comparators									
BA8391G	1	2 to 36	0.3	2.0	50	16	V_{EE} to $V_{CC}-1.5$	100	1.3	-40 to +85	SSOP5
BA2903	2	2 to 36	0.6	2.0	50	16	V_{EE} to $V_{CC}-1.5$	100	1.3	-40 to +125	SOP8/SSOP-B8/MSOP8
BA2903S										-40 to +105	
BA2901	4	2 to 36	0.8	2.0	50	16	V_{EE} to $V_{CC}-1.5$	100	1.3	-40 to +125	SOP14/SSOP-B14
BA2901S										-40 to +105	
BA10393F	2	2 to 36	0.4	1.0	50	16	V_{EE} to $V_{CC}-1.5$	106	1.3	-40 to +85	SOP8
BA10339	4	3 to 36	0.8	1.0	50	16	V_{EE} to $V_{CC}-1.5$	106	1.3	-40 to +85	SOP14/SSOP-B14

Part No.	CH	Supply Voltage (V)	Circuit current (μ A)	Input offset voltage (mV)	Input bias current (nA)	Output current (mA)	Input voltage range (V)	Voltage gain (dB)	Response time (μ s)	Operating temperature (°C)	Package
High Speed		Push-Pull Comparators									
BU7251G	1	1.8 to 5.5	15	1.0	0.001	6	V_{SS} to V_{DD}	90	0.55	-40 to +85	SSOP5
BU7251SG										-40 to +105	
BU7252	2	1.8 to 5.5	35	1.0	0.001	6	V_{SS} to V_{DD}	90	0.55	-40 to +85	SOP8/MSOP8
BU7252S										-40 to +105	
BU5265HFV	1	1.8 to 5.5	22	1.0	0.001	3.5	V_{SS} to V_{DD}	90	0.5	-40 to +85	HVSOF5
BU5265SHFV										-40 to +105	
High Speed		Open-Drain Comparators									
BU7250G	1	1.8 to 5.5	15	1.0	0.001	6	V_{SS} to V_{DD}	90	0.75	-40 to +85	SSOP5
BU7250SG										-40 to +105	
BU7253F	2	1.8 to 5.5	35	1.0	0.001	6	V_{SS} to V_{DD}	90	0.75	-40 to +85	SOP8
BU7253SF										-40 to +105	

Part No.	CH	Supply Voltage (V)	Circuit current (μ A)	Input offset voltage (mV)	Input bias current (nA)	Output current (mA)	Input voltage range (V)	Voltage gain (dB)	Response time (μ s)	Operating temperature (°C)	Package
Low Power Consumption		Push-Pull Comparators									
BU7231G	1	1.8 to 5.5	5	1.0	0.001	6	V_{SS} to V_{DD}	90	1.7	-40 to +85	SSOP5
BU7231SG										-40 to +105	
BU7232	2	1.8 to 5.5	10	1.0	0.001	6	V_{SS} to V_{DD}	90	1.7	-40 to +85	SOP8/MSOP8
BU7232S										-40 to +105	
BU5255HFV	1	1.8 to 5.5	6.5	1.0	0.001	3.5	V_{SS} to V_{DD}	90	1.6	-40 to +85	HVSOF5
BU5255SHFV										-40 to +105	
Low Power Consumption		Open-Drain Comparators									
BU7230G	1	1.8 to 5.5	5	1.0	0.001	6	V_{SS} to V_{DD}	90	1.8	-40 to +85	SSOP5
BU7230SG										-40 to +105	
BU7233F	2	1.8 to 5.5	10	1.0	0.001	6	V_{SS} to V_{DD}	90	1.8	-40 to +85	SOP8
BU7233SF										-40 to +105	

Part No.	CH	Supply Voltage (V)	Circuit current (mA)	Input offset voltage (mV)	Input bias current (nA)	Output current (mA)	Input voltage range (V)	Voltage gain (dB)	Response time (μ s)	Operating temperature (°C)	Package
Low Offset Voltage		Open-Collector Comparator									
BA2903W	2	2 to 36	0.6	0.5(Typ.)/2.0(Max.)	50	16	V_{EE} to $V_{CC}-1.5$	100	1.3	-40 to +125	SOP8/SSOP-B8

Automotive

2 grades are offered: M and C.
M-grade products are designed for car navigation and audio systems, while C-grade models are optimized for cruise control and safety systems.

Automotive Operational Amplifiers

Automotive Ground Sense Operational Amplifiers

Part No.	CH	Supply Voltage (V)	Circuit current (mA)	Input offset voltage (mV)	Input bias current (nA)	Output current (mA)	Input voltage range (V)	Output Voltage range (V)	Voltage gain (dB)	Slew rate (V/ μ s)	Gain bandwidth product (MHz)	Operating temperature (°C)	Package
BA2904Yxxx-C	2	3 to 36	0.5	2.0	20	30	V_{EE} to $V_{CC}-1.5$	V_{EE} to $V_{CC}-1.5$	100	0.2	0.5	-40 to +125	SOP8/SSOP-B8/MSOP8
BA2902Yxxx-C	4	3 to 36	0.7	2.0	20	30	V_{EE} to $V_{CC}-1.5$	V_{EE} to $V_{CC}-1.5$	100	0.2	0.5	-40 to +125	SOP14/SSOP-B14
BA2904Yxxx-M	2	3 to 36	0.5	2.0	20	30	V_{EE} to $V_{CC}-1.5$	V_{EE} to $V_{CC}-1.5$	100	0.2	0.5	-40 to +125	SOP8/SSOP-B8/MSOP8
BA2902Yxxx-M	4	3 to 36	0.7	2.0	20	30	V_{EE} to $V_{CC}-1.5$	V_{EE} to $V_{CC}-1.5$	100	0.2	0.5	-40 to +125	SOP14/SSOP-B14

High Speed Automotive Ground Sense Operational Amplifiers

Part No.	CH	Supply Voltage (V)	Circuit current (mA)	Input offset voltage (mV)	Input bias current (nA)	Output current (mA)	Input voltage range (V)	Output Voltage range (V)	Voltage gain (dB)	Slew rate (V/ μ s)	Gain bandwidth product (MHz)	Operating temperature (°C)	Package
BA3472Yxxx-C	2	3 to 36	4.0	1.0 (Typ.)/ 10.0(Max.)	100	30	V_{EE} to $V_{CC}-2.0$	$V_{EE}+0.3$ to $V_{CC}-1.0$	100	10	4.0	-40 to +125	SOP8/SSOP-B8/MSOP8
BA3474YFV-C	4	3 to 36	8.0	1.0 (Typ.)/ 10.0(Max.)	100	30	V_{EE} to $V_{CC}-2.0$	$V_{EE}+0.3$ to $V_{CC}-1.0$	100	10	4.0	-40 to +125	SSOP-B14
BA3472WVF-C	2	3 to 36	4.0	1.0 (Typ.)/ 7.5(Max.)	100	30	V_{EE} to $V_{CC}-2.0$	$V_{EE}+0.3$ to $V_{CC}-1.0$	100	10	4.0	-40 to +125	SSOP-B8
BA3474WVF-C	4	3 to 36	8.0	1.0 (Typ.)/ 7.5(Max.)	100	30	V_{EE} to $V_{CC}-2.0$	$V_{EE}+0.3$ to $V_{CC}-1.0$	100	10	4.0	-40 to +125	SSOP-B14

Low Noise Automotive Operational Amplifiers

Part No.	CH	Supply Voltage (V)	Circuit current (mA)	Input offset voltage (mV)	Input bias current (nA)	Input referred noise voltage (μ V rms)	Input voltage range (V)	Output Voltage range (V)	Voltage gain (dB)	Slew rate (V/ μ s)	Gain bandwidth product (MHz)	Operating temperature (°C)	Package
New BA4558Yxxx-M	2	± 4 to ± 15	3.0	0.5	60	1.8	$V_{EE}+1.0$ to $V_{CC}-1.0$	$V_{EE}+1.0$ to $V_{CC}-1.0$	100	1.0	2.0	-40 to +105	SOP8/SSOP-B8/MSOP8
New BA4560Yxxx-M	2	± 4 to ± 15	3.0	0.5	50	1.0	$V_{EE}+1.0$ to $V_{CC}-1.0$	$V_{EE}+1.0$ to $V_{CC}-1.0$	100	4.0	4.0	-40 to +105	SOP8/SSOP-B8/MSOP8
New BA4580Yxxx-M	2	± 2 to ± 16	6.0	0.3	100	0.8	$V_{EE}+1.5$ to $V_{CC}-1.5$	$V_{EE}+1.5$ to $V_{CC}-1.5$	110	5.0	10.0	-40 to +105	SOP8/MSOP8
BA4584YFV-M	4	± 2 to ± 16	11.0	0.3	100	0.8	$V_{EE}+1.5$ to $V_{CC}-1.5$	$V_{EE}+1.5$ to $V_{CC}-1.5$	110	5.0	10.0	-40 to +105	SSOP-B14

Automotive Comparators

Automotive Open-Collector Comparators

Part No.	CH	Supply Voltage (V)	Circuit current (mA)	Input offset voltage (mV)	Input bias current (nA)	Output current (mA)	Input voltage range (V)	Voltage gain (dB)	Response time (μ s)	Operating temperature (°C)	Package
BA2903Yxxx-C	2	2 to 36	0.6	2.0	50	16	V_{EE} to $V_{CC}-1.5$	100	1.3	-40 to +125	SOP8/SSOP-B8/MSOP8
BA2901Yxx-C	4	2 to 36	0.8	2.0	50	16	V_{EE} to $V_{CC}-1.5$	100	1.3	-40 to +125	SOP14/SSOP-B14
New BA2903Yxxx-M	2	2 to 36	0.6	2.0	50	16	V_{EE} to $V_{CC}-1.5$	100	1.3	-40 to +125	SOP8/SSOP-B8/MSOP8
New BA2901Yxx-M	4	2 to 36	0.8	2.0	50	16	V_{EE} to $V_{CC}-1.5$	100	1.3	-40 to +125	SOP14/SSOP-B14

Voltage Detectors (Reset ICs)

Voltage Detectors (Reset ICs)



New Expanded voltage detector (Reset IC) lineup

- New series: BDxxExxG (Cu wire)
BD48/49ExxG Series, BD52/53ExxG Series
- SSOP3 (SOT23-3 equivalent) series:
BD48/49KxxG Series, BD48/49LxxG Series, BU45/46KxyG Series, BU45/46LxyG Series
- Automotive-grade (AEC-Q100 compliant) series:
BD48/49ExxG-M, BD52/53ExxG-M, BD45/46ExxyG-M

Standard		Voltage Detectors				* Detection voltage is applied in the "xx" of part No. Ex. : In case of 2.3V detection voltage in BD48KxxG series, Part No. is BD48K23G.					
Part No.	Types	Voltage detection precision (%)	Voltage detection (V)	Detection step (V)	Output type	Circuit current (μA)		Hysteresis Voltage (V)	"L" Output current (mA)		Package
						ON	OFF		V _{DD} =1.2V	V _{DD} =2.4V	
New BD48ExxG Series	0.1V step 38 type	±1	2.3 to 6.0	0.1	Open Drain	0.60 (Vs=4.8V)	0.85 (Vs=4.8V)	Vs×0.05	1	4	SSOP5 [V _{OUT} /V _{DD} /GND/N.C./N.C.]
New BD48KxxG Series	0.1V step 38 type	±1	2.3 to 6.0	0.1							SSOP3 [GND]/V _{OUT} /V _{DD}
New BD48LxxG Series	0.1V step 38 type	±1	2.3 to 6.0	0.1	CMOS	0.60 (Vs=4.8V)	0.85 (Vs=4.8V)	Vs×0.05	1	4	SSOP3 [V _{OUT} /V _{DD} /GND]
New BD49ExxG Series	0.1V step 38 type	±1	2.3 to 6.0	0.1							SSOP5 [V _{OUT} /V _{DD} /GND/N.C./N.C.]
New BD49KxxG Series	0.1V step 38 type	±1	2.3 to 6.0	0.1	CMOS	0.60 (Vs=4.8V)	0.85 (Vs=4.8V)	Vs×0.05	1	4	SSOP3 [GND]/V _{OUT} /V _{DD}
New BD49LxxG Series	0.1V step 38 type	±1	2.3 to 6.0	0.1							SSOP3 [V _{OUT} /V _{DD} /GND]

Adjustable Delay Time		Voltage Detectors				* Detection voltage is applied in the "xx" of part No. Ex. : In case of 2.3V detection voltage in BD52ExxG series, Part No. is BD52E23G.					
Part No.	Types	Voltage detection precision (%)	Voltage detection (V)	Detection step (V)	Output type	Circuit current (μA)		Hysteresis Voltage (V)	"L" Output current (mA)		Package
						ON	OFF		V _{DD} =1.2V	V _{DD} =2.4V	
New BD52ExxG Series	0.1V step 38 type	±1	2.3 to 6.0	0.1	Open Drain	0.85 (V _{DET} =4.8V)	0.85 (V _{DET} =4.8V)	V _{DET} ×0.05	1.2	5	SSOP5 [V _{OUT} /V _{DD} /GND/N.C./C _T]
New BD53ExxG Series	0.1V step 38 type	±1	2.3 to 6.0	0.1	CMOS						SSOP5 [V _{OUT} /V _{DD} /GND/N.C./C _T]

Fixed Delay Time		Voltage Detectors				* Detection voltage (from 2.3V to 4.8V as 0.1V step) is applied in the "xx" and Delay time is applied in the "y" of part No. In case of 2.3V detection voltage with 200mS delay time in BU45KxyG series Part No. is BU45K232G.						
Part No.	Types	Voltage detection precision (%)	Voltage detection (V)	Detection step (V)	Output type	"H"Counter Timer Delay Time Setting (ms)	Circuit current (μA)		Hysteresis Voltage (V)	"L" Output current (mA)		Package
							ON	OFF		V _{DD} =1.2V	V _{DD} =2.4V	
New BU45KxyG Series	0.1V step 26 type	±1	2.3 to 4.8	0.1	Open Drain	200 / 400	2.3 (V _{DET} =4.8V)	2.8 (V _{DET} =4.8V)	V _{DET} ×0.05	2.0	8.5	SSOP3 [GND]/V _{OUT} /V _{DD}
New BU45LxyG Series	0.1V step 26 type	±1	2.3 to 4.8	0.1								SSOP3 [V _{OUT} /V _{DD} /GND]
New BU46KxyG Series	0.1V step 26 type	±1	2.3 to 4.8	0.1	CMOS	200 / 400	2.3 (V _{DET} =4.8V)	2.8 (V _{DET} =4.8V)	V _{DET} ×0.05	2.0	8.5	SSOP3 [GND]/V _{OUT} /V _{DD}
New BU46LxyG Series	0.1V step 26 type	±1	2.3 to 4.8	0.1								SSOP3 [V _{OUT} /V _{DD} /GND]

Automotive		Voltage Detectors				*Detection voltage is applied in the "xx" and Delay time is applied in the "y" of part No. In case of 2.3V detection voltage with 50mS delay time in BU45ExxyG-M series Part No. is BD45E235G-M						
Part No.	Types	Voltage detection precision (%)	Voltage detection (V)	Detection step (V)	Output type	"H"Counter Timer Delay Time Setting (ms)	Circuit current (μA)		Hysteresis Voltage (V)	"L" Output current (mA)		Package
							ON	OFF		V _{DD} =1.2V	V _{DD} =2.4V	
New BD48ExxG-M	0.1V step 38 type	±1	2.3 to 6.0	0.1	Open Drain	-	0.60 (Vs=4.8V)	0.85 (Vs=4.8V)	Vs×0.05	1.0	4	SSOP5 [V _{OUT} /V _{DD} /GND/N.C./N.C.]
New BD49ExxG-M	0.1V step 38 type	±1	2.3 to 6.0	0.1	CMOS	-						SSOP5 [V _{OUT} /V _{DD} /GND/N.C./N.C.]
New BD52ExxG-M	0.1V step 38 type	±1	2.3 to 6.0	0.1	Open Drain	-	0.85 (V _{DET} =4.8V)	0.85 (V _{DET} =4.8V)	V _{DET} ×0.05	1.2	5	SSOP5 [V _{OUT} /V _{DD} /GND/N.C./C _T]
New BD53ExxG-M	0.1V step 38 type	±1	2.3 to 6.0	0.1	CMOS	-						SSOP5 [V _{OUT} /V _{DD} /GND/N.C./C _T]
New BD45ExxyG-M	0.1V step 26 type	±1	2.3 to 4.8	0.1	Open Drain	50 / 100 / 200	0.80 (V _{DET} =4.8V)	0.85 (V _{DET} =4.8V)	V _{DET} ×0.05	1.2	5	SSOP5 [ER/SUB(GND)]/GND/V _{OUT} /V _{DD}
New BD46ExxyG-M	0.1V step 26 type	±1	2.3 to 4.8	0.1	CMOS							SSOP5 [ER/SUB(GND)]/GND/V _{OUT} /V _{DD}

Voltage Detectors (Reset ICs)

Regarding package and pin layout

Ex: SSOP5 (V_{OUT}/V_{DD}/GND/N.C./N.C.)
 [] denotes the pin layout: Pin 1, 2, 3 (in order)
 V_{DD}: Input V_{OUT}: Reset Output GND: Ground Pin Cr: Delay Time Setting Terminal
 SUB: Substrate (Connect in accordance with GND or V_{DD} specifications) ER: Manual Reset

Standard		Voltage Detectors										
Part No.	Types	Voltage detection precision (%)	Voltage detection (V)	Detection step (V)	Output type	Circuit current (μA)		Hysteresis Voltage (V)	"L" Output current (mA)		Manual reset input	Package
						ON	OFF		V _{DD} =1.2V	V _{DD} =2.4V		
BD48xxG Series	0.1V step 38 type	±1	2.3 to 6.0	0.1	Open Drain	0.60 (V _S =4.8V)	0.85 (V _S =4.8V)	V _S ×0.05	1	4	-	SSOP5 [V _{OUT} /V _{DD} /GND/N.C./N.C.]
BD48xxFVE Series	0.1V step 38 type	±1	2.3 to 6.0	0.1							-	VSO5 [V _{OUT} /SUB(GND)/N.C./GND/V _{DD}]
BD49xxG Series	0.1V step 38 type	±1	2.3 to 6.0	0.1	CMOS	0.40 (V _{DET} =4.8V)	0.55 (V _{DET} =4.8V)	V _{DET} ×0.05	3.3	6.5	-	SSOP5 [V _{OUT} /V _{DD} /GND/N.C./N.C.]
BD49xxFVE Series	0.1V step 38 type	±1	2.3 to 6.0	0.1							-	VSO5 [V _{OUT} /SUB(GND)/N.C./GND/V _{DD}]
BU48xxG Series	0.1V step 40 type	±1	0.9 to 4.8	0.1	Open Drain	0.40 (V _{DET} =4.8V)	0.55 (V _{DET} =4.8V)	V _{DET} ×0.05	3.3	6.5	-	SSOP5 [V _{OUT} /V _{DD} /GND/N.C./N.C.]
BU48xxFVE Series	0.1V step 40 type	±1	0.9 to 4.8	0.1							-	VSO5 [V _{OUT} /SUB(V _{DD})/N.C./V _{DD} /GND]
BU48xxF Series	0.1V step 40 type	±1	0.9 to 4.8	0.1	CMOS	0.40 (V _{DET} =4.8V)	0.55 (V _{DET} =4.8V)	V _{DET} ×0.05	3.3	6.5	-	SOP4 [V _{OUT} /V _{DD} /N.C./GND]
BU49xxG Series	0.1V step 40 type	±1	0.9 to 4.8	0.1							-	SSOP5 [V _{OUT} /V _{DD} /GND/N.C./N.C.]
BU49xxFVE Series	0.1V step 40 type	±1	0.9 to 4.8	0.1	CMOS	0.40 (V _{DET} =4.8V)	0.55 (V _{DET} =4.8V)	V _{DET} ×0.05	3.3	6.5	-	VSO5 [V _{OUT} /SUB(V _{DD})/N.C./V _{DD} /GND]
BU49xxF Series	0.1V step 40 type	±1	0.9 to 4.8	0.1							-	SOP4 [V _{OUT} /V _{DD} /N.C./GND]

*Detection voltage (from 2.3V to 6.0V as 0.1V step) is applied in the xx of part No.
 Ex : In case of 2.3V detection voltage in BD48xxG series, part No. is BD4823G.

With Adjustable Delay Time		Voltage Detectors										
Part No.	Types	Voltage detection precision (%)	Voltage detection (V)	Detection step (V)	Output type	Circuit current (μA)		Hysteresis Voltage (V)	"L" Output current (mA)		Manual reset input	Package
						ON	OFF		V _{DD} =1.2V	V _{DD} =2.4V		
BD52xxG Series	0.1V step 38 type	±1	2.3 to 6.0	0.1	Open Drain	0.85 (V _{DET} =4.8V)	0.85 (V _{DET} =4.8V)	V _{DET} ×0.05	1.2	5	-	SSOP5 [V _{OUT} /V _{DD} /GND/N.C./Cr]
BD52xxFVE Series	0.1V step 38 type	±1	2.3 to 6.0	0.1							-	VSO5 [V _{OUT} /SUB(GND)/Cr/GND/V _{DD}]
BD53xxG Series	0.1V step 38 type	±1	2.3 to 6.0	0.1	CMOS	0.40 (V _{DET} =4.8V)	0.55 (V _{DET} =4.8V)	V _{DET} ×0.05	3.3	6.5	-	SSOP5 [V _{OUT} /V _{DD} /GND/N.C./Cr]
BD53xxFVE Series	0.1V step 38 type	±1	2.3 to 6.0	0.1							-	VSO5 [V _{OUT} /SUB(GND)/Cr/GND/V _{DD}]
BU42xxG Series	0.1V step 40 type	±1	0.9 to 4.8	0.1	Open Drain	0.40 (V _{DET} =4.8V)	0.55 (V _{DET} =4.8V)	V _{DET} ×0.05	3.3	6.5	-	SSOP5 [V _{OUT} /V _{DD} /GND/N.C./Cr]
BU42xxFVE Series	0.1V step 40 type	±1	0.9 to 4.8	0.1							-	VSO5 [V _{OUT} /SUB(V _{DD})/Cr/V _{DD} /GND]
BU42xxF Series	0.1V step 40 type	±1	0.9 to 4.8	0.1	CMOS	0.40 (V _{DET} =4.8V)	0.55 (V _{DET} =4.8V)	V _{DET} ×0.05	3.3	6.5	-	SOP4 [GND/V _{DD} /Cr/V _{OUT}]
BU43xxG Series	0.1V step 40 type	±1	0.9 to 4.8	0.1							-	SSOP5 [V _{OUT} /V _{DD} /GND/N.C./Cr]
BU43xxFVE Series	0.1V step 40 type	±1	0.9 to 4.8	0.1	CMOS	0.40 (V _{DET} =4.8V)	0.55 (V _{DET} =4.8V)	V _{DET} ×0.05	3.3	6.5	-	VSO5 [V _{OUT} /SUB(V _{DD})/Cr/V _{DD} /GND]
BU43xxF Series	0.1V step 40 type	±1	0.9 to 4.8	0.1							-	SOP4 [GND/V _{DD} /Cr/V _{OUT}]

*Detection voltage (from 2.3V to 6.0V as 0.1V step) is applied in the xx of part No.
 Ex : In case of 2.3V detection voltage in BD52xxG series, part No. is BD5223G.

With Fixed Delay Time		Voltage Detectors											
Part No.	Types	Voltage detection precision (%)	Voltage detection (V)	Detection step (V)	Output type	*H ⁺ Cover Timer Delay Time Setting (ms)	Circuit current (μA)		Hysteresis Voltage (V)	"L" Output current (mA)		Manual reset input	Package
							ON	OFF		V _{DD} =1.2V	V _{DD} =2.4V		
BD45xx5G Series	0.1V step 26 type	±1	2.3 to 4.8	0.1	Open Drain	50	0.80 (V _{DET} =4.8V)	0.85 (V _{DET} =4.8V)	V _{DET} ×0.05	1.2	5	✓	SSOP5 [ER/SUB(GND)/GND/V _{OUT} /V _{DD}]
BD45xx1G Series	0.1V step 26 type	±1	2.3 to 4.8	0.1								✓	SSOP5 [ER/SUB(GND)/GND/V _{OUT} /V _{DD}]
BD45xx2G Series	0.1V step 26 type	±1	2.3 to 4.8	0.1	CMOS	100	0.80 (V _{DET} =4.8V)	0.85 (V _{DET} =4.8V)	V _{DET} ×0.05	1.2	5	✓	SSOP5 [ER/SUB(GND)/GND/V _{OUT} /V _{DD}]
BD46xx5G Series	0.1V step 26 type	±1	2.3 to 4.8	0.1								✓	SSOP5 [ER/SUB(GND)/GND/V _{OUT} /V _{DD}]
BD46xx1G Series	0.1V step 26 type	±1	2.3 to 4.8	0.1	CMOS	200	0.80 (V _{DET} =4.8V)	0.85 (V _{DET} =4.8V)	V _{DET} ×0.05	1.2	5	✓	SSOP5 [ER/SUB(GND)/GND/V _{OUT} /V _{DD}]
BD46xx2G Series	0.1V step 26 type	±1	2.3 to 4.8	0.1								✓	SSOP5 [ER/SUB(GND)/GND/V _{OUT} /V _{DD}]

*Detection voltage (from 2.3V to 4.8V as 0.1V step) is applied in the xx of part No.
 Ex : In case of 2.3V detection voltage in BD45xx5G series, part No. is BD45235G.

With SENSE Pin		Voltage Detector									
Part No.	Input Voltage (V)	Output Voltage (V)	I _{CC} (μA)	Voltage Detection (V)	Delay Time	Package					
BD4142HFV	3.0 to 5.5	to 5.5 (Open Drain)	7.5	Variable (0.5 to)	Variable	HVSOF5					

With Watchdog Timer		Reset ICs									
Part No.	Voltage detection (V)	Voltage detection precision (%)	Output type	INH mode (Active)	"L" Output current (mA)	RESET Active Voltage Range (V)	WDT active voltage range (V)	Circuit current (μA)	Thermal operational range (°C)	Package	Automotive Grade
BD37A19FVM	1.9	±1.5 (Ta=25°C)	Open Drain	H	0.7	1.0 to 10	2.5 to 10	5	-40 to +105	MSOP8	✓
BD37A41FVM	4.1	±1.5 (Ta=25°C)	Open Drain	H	0.7	1.0 to 10	2.5 to 10	5	-40 to +105	MSOP8	✓
BD87A28FVM	2.8	±1.5 (Ta=25°C)	Open Drain	L	0.7	1.0 to 10	2.5 to 10	5	-40 to +105	MSOP8	✓
BD87A29FVM	2.9	±1.5 (Ta=25°C)	Open Drain	L	0.7	1.0 to 10	2.5 to 10	5	-40 to +105	MSOP8	✓
BD87A34FVM	3.4	±1.5 (Ta=25°C)	Open Drain	L	0.7	1.0 to 10	2.5 to 10	5	-40 to +105	MSOP8	✓
BD87A41FVM	4.1	±1.5 (Ta=25°C)	Open Drain	L	0.7	1.0 to 10	2.5 to 10	5	-40 to +105	MSOP8	✓
BD99A41F	4.1	±1.5 (Ta=25°C)	Open Drain	H	0.7	1.0 to 10	2.5 to 10	5	-40 to +105	SOP8	✓

1ch Linear Regulators

Lineup

●: P.14 ●: P.15 ●: P.16 ●: P.14, P.16
 Please refer to the specifications on our website regarding products with no marking code

Output Current / Maximum Rated Input Voltage	0.15A	0.2A	0.3A	0.5A	1.0A	1.5A	2.0A	3.0A	4.0A	External MOSFET
45-50V	BD4269F-C*2/3	●BD7xxL2*1/2 BD3010AFV-M*2/3 ●BD4xxM2*1/2 ●BD4xxM2W*1/2		●BD7xxL5FP-C*2 ●BD3570/1/2/3/4/5*1/2 BD3004/5HFP*2 BD3020/1HFP-M*2 ●BD4xxM5*1/2 ●BD4xxM5W*1/2 BD4275*1/2/3						
30-36V	BD3951F*2/3 BDxxFA1FP3*1		●BD3650FP-M*2 BA3662CP-V5	BA178Mxx*1	●BA178xx*1 ●BDxxC0A*1/2 ●BDxxC0AW*1/2 ●BDxxFC0*1 ●BAxxCC0*1 ●BAxxCC0W*1		●BD00D0AWHFP ●BAxxDD0*1 ●BAxxDD0W*1			
18V					●BAxxBC0*1 ●BAxxBC0W*1	●BAxxJC5T ●BA00JC5WT				
15V			●BDxxGA3*1/2	●BDxxGA5*1/2	●BDxxGC0*1/2 ●BA1117FP					
10V			●BDxxHA3*1/2	●BDxxHA5*1/2	●BDxxHC0*1/2 ●BDxxIC0*1/2	●BDxxHC5*1/2				
7V/6.5V	●BHxxNB1WHFV ●BHxxPB1WGUT ●BHxxPB1WHFV ●BHxxSA3WGUT	●BUxxSD2MG-M*2 ●BUxxTD2WNVX ●BUxxTD3WG ●BUxxTA2W*1 ●BUxxSA4WGWL	●BUxxUB3WG ●BUxxUA3WNVX ●BUxxUC3WG ●BHxxM0AWHFV ●BHxxMA3WHFV	●BDxxIA5*1/2 ●BDxxKA5FP ●BDxxKA5W*1 BUxxSA5						
Ultra Low Voltage (Dual Supply)				BD3550HFN BD3507HFV BD3540NUV	BD3551HFN BD35269HFN BD3541NUV BD00J00MNUX-M	BD35281HFN	BD3552HFN BD3506F BD3523HFN BD35230HFN BD35231HFN	BD3508MUV BD3512MUV	BD35221EFV BD35222EFV BD3509MUV	BD3504FVM BD3521FVM

*1: Package Lineup *2: Automotive Grade *3: Multi-Function Regulator (Ex. Voltage Detection)

1ch LDO Regulators

BD00FC0WEFJ

NEW

Key Features

- Max. rated input voltage: 35V
- Output current: 1A
- High output voltage accuracy: ±1%
- Compatible with ceramic output capacitors
- Thin surface mount power package (HTSOP-J8)

Application Circuit

Overcurrent Protection (OCP) Function

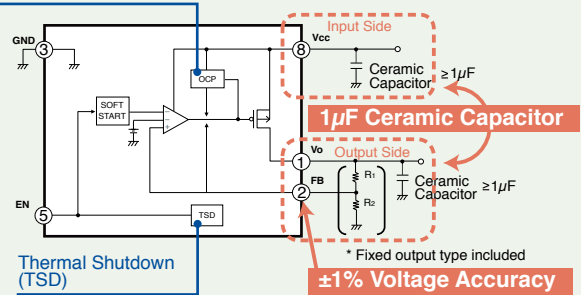

Ultra-Compact CMOS LDOs

BUxxUA3WNVX/BUxxUC3WG

Key Features

- Max. rated input voltage: 6V
- Output current: 300mA
- High output voltage accuracy: ±1% (±25mV, V_{OUT} < 2.5V)
- Supports output capacitors as low as 0.47µF
- Overcurrent protection, thermal shut down function
- Built-in output discharge circuit
- Available in the ultra-compact SSON004X1010 and standard SSOP5 (SOT23-5 equivalent) package types

Block Diagram

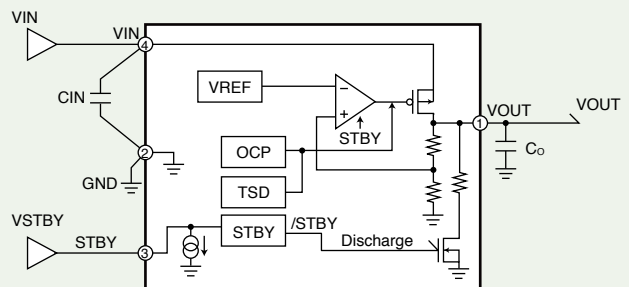

Input-Output Voltage Difference (TD2 Comparison)

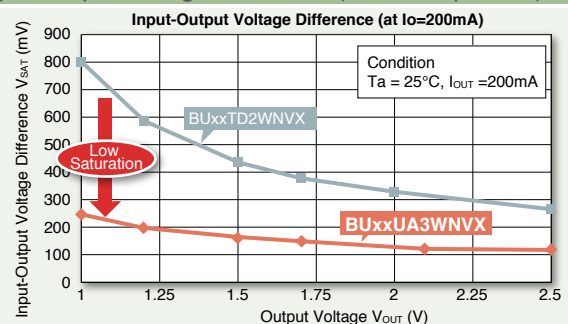

1ch Linear Regulators

Standard Voltage		Regulators						
Part No.	Absolute Max. Input Voltage (V)	Output Current (Max.)	Output Voltage (V)	Output Voltage Accuracy (%)	Bias Current (Typ.)	Input-Output Voltage Difference	Features	Package
BA178xx	35	1.0A	5/6/7/8/9/10/12/15/18/20/24	±4	4.5mA	2V (I _{OUT} =0.5A)	OCP/TSD	TO220CP-3/TO252-3
BA178Mxx	35	500mA	5/6/7/8/9/10/12/15/18/20/24	±4	4.5mA	2V (I _{OUT} =1A)	OCP/TSD	TO220CP-3/TO252-3
New BA1117FP	15	1.0A	ADJ	±1	1.7mA	1.2V (I _{OUT} =1A)	OCP/TSD	TO252-3

Low Drop-Out Linear Regulators		Regulators						
Part No.	Absolute Max. Input Voltage (V)	Output current (Max.)	Output voltage (V)	Output Voltage Accuracy (%)	Bias Current (Typ.)	Input-Output voltage Difference	Features	Package
BAxxDD0	35	2.0A	1.5/1.8/2.5/3.0/3.3/5.0/9.0/12.0/16.0	±1	0.9mA	0.45V (I _{OUT} =2A)	OVP/OCP/TSD	TO220FP-3
BAxxDD0W	35	2.0A	ADJ/1.5/1.8/2.5/3.0/3.3/5.0/9.0/12.0/16.0	±1	0.9mA	0.45V (I _{OUT} =2A)	OVP/OCP/TSD/EN	TO220CP-V5/ TO220FP-5/HRP5
BD0000AWHFP	35	2.0A	ADJ	±1	0.5mA	0.4V (I _{OUT} =1A)	OCP/TSD/EN/ Ceramic capacitor supported	HRP5
BAxxCC0	35	1.0A	3.0/3.3/5.0/6.0/7.0/8.0/9.0/10.0/12.0/15.0	±2	2.5mA	0.3V (I _{OUT} =0.5A)	OVP/OCP/TSD	TO220FP-3/TO252-3
BAxxCC0W	35	1.0A	ADJ/ 3.0/3.3/5.0/6.0/7.0/8.0/9.0/10.0/12.0	±2	2.5mA	0.3V (I _{OUT} =0.5A)	OVP/OCP/TSD/EN	TO220CP-V5 TO220FP-5/TO252-5
BDxxC0AFPS	35	1.0A	8.0/9.0	±1	0.6mA	0.3V (I _{OUT} =0.5A)	OCP/TSD/Ceramic capacitor supported	TO252S-3
BDxxC0AW	35	1.0A	ADJ/ 3.3/5.0	±1	0.5mA	0.3V/0.4V (I _{OUT} =0.5A)	OCP/TSD/EN/Ceramic capacitor supported	TO252-5/TO220CP-V5
New BDxxFC0	35	1.0A	ADJ	±1	0.5mA	0.3V (I _{OUT} =0.5A)	OCP/TSD/EN/Soft-start/Ceramic capacitor supported	HTSOP-J8
BAxxJC5T	18	1.5A	1.5/1.8/2.5/3.0/3.3/5.0/6.0/6.3/8.0/9.0	±1	0.5mA	0.3V (I _{OUT} =0.5A)	OCP/TSD	TO220FP-3
BA00JC5WT	18	1.5A	ADJ	±1	0.5mA	0.3V (I _{OUT} =0.5A)	OCP/TSD/EN/Ceramic capacitor supported	TO220FP-5
BAxxBC0	18	1.0A	1.5/1.8/2.5/3.0/3.3/5.0/6.0/7.0/8.0/9.0/10.0	±2	0.5/0.6mA	0.3V (I _{OUT} =0.2A)	OCP/TSD	TO252-3/TO220FP-3
BAxxBC0W	18	1.0A	ADJ/ 1.5/1.8/2.5/3.0/3.3/5.0/6.0/7.0/8.0/9.0/10.0	±2	0.5/0.6mA	0.3V (I _{OUT} =0.2A)	OCP/TSD/EN	TO252-5/TO220CP-V5/ TO220FP-5
BDxxGC0WEFJ	15	1.0A	ADJ/ 1.5/1.8/2.5/3.0/3.3/5.0/6.0/7.0/8.0/9.0/10.0/12.0	±1	0.6mA	0.6V (I _{OUT} =1A)	OCP/TSD/EN/Soft-start/Ceramic capacitor supported	HTSOP-J8
BDxxGA5WEFJ	15	0.5A	ADJ/ 1.5/1.8/2.5/3.0/3.3/5.0/6.0/7.0/8.0/9.0/10.0/12.0	±1	0.6mA	0.6V (I _{OUT} =0.5A)	OCP/TSD/EN/Soft-start/Ceramic capacitor supported	HTSOP-J8
BDxxGA3W	15	0.3A	ADJ/ 1.5/1.8/2.5/3.0/3.3/5.0/6.0/7.0/8.0/9.0/10.0/12.0	±1	0.6mA	0.6V (I _{OUT} =0.3A)	OCP/TSD/EN/Soft-start/Ceramic capacitor supported	HTSOP-J8/ VSON008X2030
BDxxHC5WEFJ	10	1.5A	ADJ/ 1.5/1.8/2.5/3.0/3.3/5.0/6.0/7.0	±1	0.6mA	0.6V (I _{OUT} =1.5A)	OCP/TSD/EN/Soft-start/Ceramic capacitor supported	HTSOP-J8
BDxxHC0WEFJ	10	1.0A	ADJ/ 1.5/1.8/2.5/3.0/3.3/5.0/6.0/7.0	±1	0.6mA	0.6V (I _{OUT} =1A)	OCP/TSD/EN/Soft-start/Ceramic capacitor supported	HTSOP-J8
BDxxHA5WEFJ	10	0.5A	ADJ/ 1.5/1.8/2.5/3.0/3.3/5.0/6.0/7.0	±1	0.6mA	0.6V (I _{OUT} =0.5A)	OCP/TSD/EN/Soft-start/Ceramic capacitor supported	HTSOP-J8
BDxxHA3WEFJ	10	0.3A	ADJ/ 1.5/1.8/2.5/3.0/3.3/5.0/6.0/7.0	±1	0.6mA	0.6V (I _{OUT} =0.3A)	OCP/TSD/EN/Soft-start/Ceramic capacitor supported	HTSOP-J8
BDxxKA5FP	7	0.5A	1.0/1.2/1.5/1.8/2.5/3.0/3.3	±1	0.35mA	0.12V (I _{OUT} =0.2A)	OCP/TSD/Ceramic capacitor supported	TO252-3
BDxxKA5W	7	0.5A	ADJ/ 1.0/1.2/1.5/1.8/2.5/3.0/3.3	±1	0.35mA	0.12V (I _{OUT} =0.2A)	OCP/TSD/EN/Ceramic capacitor supported	TO252-5/SOP8
BDxxLC0W	7	1.0A	ADJ/ 1.0/1.2/1.25/1.5/1.8/2.5/2.6/3.0/3.3	±1	0.25mA	0.4V (I _{OUT} =1A)	OCP/TSD/EN/Soft-start/Ceramic capacitor supported	HTSOP-J8/HVSO6
BDxxIA5WEFJ	7	0.5A	ADJ/ 1.0/1.2/1.5/1.8/2.5/3.0/3.3	±1	0.25mA	0.4V (I _{OUT} =0.5A)	OCP/TSD/EN/Soft-start/Ceramic capacitor supported	HTSOP-J8

Portable CMOS LDO		Regulators						
Part No.	Power Supply Range (V)	Output Current (Max.)	Output Voltage (V)	Output Voltage Accuracy	Bias Current (Typ.)	Input-Output Voltage Difference	Features	Package
New BUxxUA3WNVX	1.7 to 5.5	300mA	1.0 to 4.0V/0.05 Step	±25mV (V _{OUT} < 2.5V)±1	50μA	200mV (I _O =300mA/2.5V ≤ V _{OUT})	OCP/TSD/EN	SSON004X1010
BUxxUC3WG	1.7 to 5.5	300mA	1.0 to 4.0V/0.05 Step	±25mV (V _{OUT} < 2.5V)±1	50μA	200mV (I _O =300mA/2.5V ≤ V _{OUT})	OCP/TSD/EN	SSOP5
BHxxM0AWHFV	2.5 to 5.5	300mA	1.5/1.8/2.0/2.1/2.5/2.6/2.7/2.8/2.9/3.0/ 3.1/3.2/3.3/3.4	±25mV (V _{OUT} < 2.5V)±1	65μA	60mV (I _O =100mA/2.5V ≤ V _{OUT})	OCP/TSD/EN	HVSOF6
BHxxMA3WHFV	2.5 to 5.5	300mA	1.5/1.8/2.5/2.8/2.9/3.0/3.1/3.3	±25mV (V _{OUT} ≤ 1.8V)±1	65μA	60mV (I _O =100mA/2.5V ≤ V _{OUT})	OCP/TSD/EN	HVSOF6
BUxxTD2WNVX	1.7 to 6.0	200mA	1.0/1.05/1.1/1.15/1.2/1.25/1.3/1.5/1.8/1.85/1.9/2.0/2.05/ 2.1/2.2/2.5/2.6/2.7/2.75/2.8/2.85/2.9/3.0/3.1/3.2/3.3/3.4	±25mV (V _{OUT} ≤ 2.3V)±1	35μA	220-280mV (I _O =200mA/Depending V _{OUT})	OCP/TSD/EN/Discharge	SSON004X1010
BUxxTD3WG	1.7 to 6.0	200mA	1.0/1.1/1.2/1.25/1.3/1.5/1.8/1.85/1.9/2.0/2.1/ 2.5/2.6/2.7/2.8/2.85/2.9/3.0/3.1/3.2/3.3/3.4	±25mV (V _{OUT} ≤ 2.3V)±1	35μA	220 - 280mV (I _O =200mA/Depending V _{OUT})	OCP/TSD/EN/Discharge	SSOP5
BUxxTA2W	2.5 to 5.5	200mA	1.5/1.8/2.5/2.6/2.7/2.8/2.85/2.9/3.0/ 3.1/3.2/3.3/3.4	±25mV (V _{OUT} ≤ 1.8V)±1	40μA	300-400mV (I _O =200mA/Depending V _{OUT})	OCP/TSD/EN/Discharge	SSON004X1216/ HVSOF5
BHxxPB1WHFV	1.7 to 5.5	150mA	1.2/1.5/1.8/2.5/2.8/2.9/3.0/3.1/3.3	±25mV (V _{OUT} ≤ 1.8V)±1 (High speed operation mode)	20μA (High speed mode)/ 2μA (Low power mode)	210mV (I _O =100mA/2.5V ≤ V _{OUT})	Auto power save mode/ OCP/TSD/EN/Discharge	HVSOF5
BHxxNB1WHFV	2.5 to 5.5	150mA	2.5/2.8/2.85/2.9/3.0/3.1/3.3	±1	60μA	250mV (I _O =100mA)	Low output noise/OCP/ TSD/EN	HVSOF5
BHxxRB1WGUT	2.5 to 5.5	150mA	1.5/1.8/2.5/2.8/2.9/3.0/3.1/3.3	±25mV (V _{OUT} ≤ 1.8V)±1	34μA	100mV (I _O =100mA/2.5V ≤ V _{OUT})	High PSRR/OCP/TSD/EN	VCSP60N1 (1.04x1.0), H=0.675Max
New BHxxSA3WGUT	2.2 to 5.5	150mA	1.8/2.8/3.0	±25mV (V _{OUT} ≤ 1.8V)±1	40μA	100mV (I _O =100mA/2.8V ≤ V _{OUT})	OCP/TSD/EN/Discharge	VCSP60N1
BUxxSA4WGWL	1.7 to 5.5	200mA	1.8/2.5/2.55/2.8/3.0/3.3	±2	40μA	80-100mA (I _O =150mA/Depending V _{OUT})	OCP/TSD/EN	UCSP50L1

*ADJ: Adjustment, OCP: Over Current Protection, OVP: Over Voltage Protection, TSD: Thermal Shutdown, EN: Enable/Shutdown switch

*Specifications (i.e. output voltage, package) may change without notice. Please refer to the latest datasheets for the most up-to-date information.
*Not all package and voltage combinations are available.

A wide range of products not listed above are available. Please visit our website for more information.

Access Our Website

www.rohm.com

ROHM Co., Ltd.

Automotive

Automotive LDO Regulators

Type	Input voltage (V)	Output voltage (V)	Output voltage precision (%)	Output current (A)	Saturation voltage : Io=200mA (V)	Circuit Current (μA)	Operating temperature (°C)	Shutdown Switch	Protection circuit	Package Part No.	
										TO252-5	HRP5
50V Resistance Output 500mA LDO Regulators											
BD3570	4.5 to 36.0	3.3	±2 (Ta=-40 to +125°C)	0.5	0.25	30	-40 to +125	-	Over-Current/ Temperature	BD3570YFP (TO252-3)	BD3570YHFP
BD3571	5.5 to 36.0	5.0								BD3571YFP (TO252-3)	BD3571YHFP
BD3572	4.5 to 36.0	Variable 2.8 to 12.0								BD3572YFP	BD3572YHFP
BD3573		3.3								BD3573YFP	BD3573YHFP
BD3574	5.5 to 36.0	5.0								BD3574YFP	BD3574YHFP
BD3575	4.5 to 36.0	Variable 2.8 to 12.0								BD3575YFP	BD3575YHFP

Part No.											Package
50V Resistance Output Low quiescent current 500mA LDO Regulators											

New BD733L5FP-C	4.17 to 45.0	3.3	±2 (Ta=-40 to +125°C)	0.5	0.4	6.0	-40 to +125	-	Over-Current/ Temperature	TO252-3	
New BD750L5FP-C	5.6 to 45.0	5.0			0.25					TO252-3	

50V Resistance Output Low quiescent current 200mA LDO Regulators										
-------------------------------------------------------------------------	--	--	--	--	--	--	--	--	--	--

BD733L2EFJ-C	4.37 to 45.0	3.3	±2 (Ta=-40 to +125°C)	0.2	0.6	6.0	-40 to +125	-	Over-Current/ Temperature	HTSOP-J8	
New BD733L2FP-C	4.37 to 45.0	3.3			0.6					TO252-3	
New BD733L2FP3-C					0.4					SOT223-4	
BD750L2EFJ-C	5.8 to 45.0	5.0			0.4					HTSOP-J8	
New BD750L2FP-C	5.8 to 45.0	5.0			0.4					TO252-3	
New BD750L2FP3-C					0.4					SOT223-4	

Type	Input voltage (V)	Output voltage (V)	Output voltage precision (%)	Output current (A)	Saturation voltage (V)	Circuit Current (μA)	Operating temperature (°C)	Shutdown Switch	Protection circuit	Package Part No.			
										TO252-3	TO263-3	TO263-5	TO252-J5

45V Resistance Output Low quiescent current 500mA LDO Regulators													
-------------------------------------------------------------------------	--	--	--	--	--	--	--	--	--	--	--	--	--

New BD433M5	4.0 to 42.0	3.3	±2 (Tj = -40 to +150°C)	0.5	0.25(Io=300mA)	38	-40 to +125°C	-	Over-Current/ Temperature	BD433M5FP-C	BD433M5FP2-C	-	-
New BD450M5	5.5 to 42.0	5.0			0.2(Io=300mA)					BD450M5FP-C	BD450M5FP2-C	-	-
New BD433M5W	4.0 to 42.0	3.3			0.25(Io=300mA)					-	-	BD433M5WFP2-C	BD433M5WFPJ-C
New BD450M5W	5.5 to 42.0	5.0			0.2(Io=300mA)					-	-	BD450M5WFP2-C	BD450M5WFPJ-C

45V Resistance Output Low quiescent current 200mA LDO Regulators										
-------------------------------------------------------------------------	--	--	--	--	--	--	--	--	--	--

Type	Input voltage (V)	Output voltage (V)	Output voltage precision (%)	Output current (A)	Saturation voltage (V)	Circuit Current (μA)	Operating temperature (°C)	Shutdown Switch	Protection circuit	Package Part No.		
										HTSOP-J8	SOT223-4	
New BD433M2	3.9 to 42.0	3.3	±2 (Tj = -40 to +150°C)	0.2	0.2(Io=100mA)	40	-40 to +125°C	-	Over-Current/ Temperature	BD433M2EFJ-C		BD433M2FP3-C
New BD450M2	5.5 to 42.0	5.0			0.16(Io=100mA)					BD450M2EFJ-C		BD450M2FP3-C
New BD433M2W	3.9 to 42.0	3.3			0.2(Io=100mA)					BD433M2WEFJ-C		BD433M2WFP3-C
New BD450M2W	5.5 to 42.0	5.0			0.16(Io=100mA)					BD450M2WEFJ-C		BD450M2WFP3-C

Part No.	Input voltage (V)	Output voltage (V)	Output voltage precision (%)	Output current (A)	Saturation voltage (V)	Circuit Current (mA)	Operating temperature (°C)	Protection circuit	Package
36V Resistance Output 300mA LDO Regulators									
BD3650FP-M	5.6 to 30.0	5.0	±2 (Ta=-40 to +125°C)	0.3	0.2 (Io=200mA)	0.5	-40 to +125	Over-Current/ Temperature	TO252-3

Type	Input Voltage (V)	Output Voltage (V)	Output Voltage precision (%)	Output current (A)	Bias current (mA)	Saturation voltage (V)	Ripple Rejection (dB)	Load Regulation (V)	Protection circuit	Package Part No.		
										TO252-3	HRP5	TO263-3

35V Resistance Output 1A LDO Regulators												
------------------------------------------------	--	--	--	--	--	--	--	--	--	--	--	--

BD33C0A	4.3 to 26.5	3.3	±3.0 (Ta=-40 to +125°C)	1.0	0.5	-	55	Vo×0.01 (Io=5mA to 1A)	Over-Current/ Temperature	BD33C0AFP-C	BD33C0AHFP-C	New BD33C0AFP2-C
BD50C0A	6.0 to 26.5	5.0				0.3 (Io=500mA)				BD50C0AFP-C	BD50C0AHFP-C	New BD50C0AFP2-C
BD80C0A	9.0 to 26.5	8.0				50	BD80C0AFP-C			BD80C0AHFP-C	New BD80C0AFP2-C	
BD90C0A	10.0 to 26.5	9.0				50	BD90C0AFP-C			BD90C0AHFP-C	New BD90C0AFP2-C	

35V Resistance Output 1A LDO Regulators with Shutdown										
--------------------------------------------------------------	--	--	--	--	--	--	--	--	--	--

Part No.	Input voltage (V)	Output voltage (V)	Output voltage precision (%)	Output current (A)	Bias current (mA)	Saturation voltage (V)	Ripple Rejection (dB)	Load Regulation (V)	Protection circuit	Package		
BD00C0AWFPS-M	4.0 to 26.5	Variable 3.0 to 15.0	±3 (Ta=-40 to +105°C)	1.0		0.3(Io=500mA)			Over-Current/ Temperature	TO252S-5		
Type	Input Voltage (V)	Output Voltage (V)	Output Voltage precision (%)	Output current (A)	Bias current (mA)	Saturation voltage (V)	Ripple Rejection (dB)	Load Regulation (V)	Protection circuit	Package Part No.		
BD00C0AW	4.0 to 26.5	Variable 1.0 to 15.0	±3.0 (Ta=-40 to +125°C)	1.0	0.5	0.3 (Io=500mA)	55	Vo×0.01 (Io=5mA to 1A)	Over-Current/ Temperature	BD00C0AWFP-C	BD00C0AWHFP-C	New BD00C0AWFP2-C
BD33C0AW	4.3 to 26.5	3.3				-				BD33C0AWFP-C	BD33C0AWHFP-C	New BD33C0AWFP2-C
BD50C0AW	6.0 to 26.5	5.0				0.3 (Io=500mA)	BD50C0AWFP-C			BD50C0AWHFP-C	New BD50C0AWFP2-C	
BD80C0AW	9.0 to 26.5	8.0				50	BD80C0AWFP-C			BD80C0AWHFP-C	New BD80C0AWFP2-C	
BD90C0AW	10.0 to 26.5	9.0				50	BD90C0AWFP-C			BD90C0AWHFP-C	New BD90C0AWFP2-C	

Automotive

Automotive Secondary LDO Regulators

Part No.	Input Voltage (V)	Output Voltage (V)	Output Voltage precision (%)	Output current (A)	Bias current (mA)	Saturation voltage (V)	Ripple Rejection (dB)	Load Regulation (mV)	Input Capacitor (μ F)	Output Capacitor (μ F)	Shutdown Switch	Protection circuit	Package
15V Resistance Output		1A LDO Regulators with Shutdown											
BDxxGC0MEFJ-M	4.5 to 14.0	ADJ (1.5 to 13.0)/ 1.5/1.8/2.5/3.0/ 3.3/5.0/6.0/7.0/ 8.0/9.0/10.0/12.0	± 3.0 (Ta=-40 to +105°C)	1.0	0.6	0.6 (Io=1A)	60 (f=100Hz, 50mVpp, Io=0A)	25 (Io=0 to 1A)	1.0	1.0	✓	Over-Current/ Temperature	HTSOP-J8
15V Resistance Output		500mA LDO Regulators with Shutdown											
BDxxGA5MEFJ-M	4.5 to 14.0	ADJ (1.5 to 13.0)/ 1.5/1.8/2.5/3.0/ 3.3/5.0/6.0/7.0/ 8.0/9.0/10.0/12.0	± 3.0 (Ta=-40 to +105°C)	0.5	0.6	0.6 (Io=500mA)	60 (f=100Hz, 50mVpp, Io=0A)	25 (Io=0 to 500mA)	1.0	1.0	✓	Over-Current/ Temperature	HTSOP-J8
15V Resistance Output		300mA LDO Regulators with Shutdown											
BDxxGA3MEFJ-M	4.5 to 14.0	ADJ (1.5 to 13.0)/ 1.5/1.8/2.5/3.0/ 3.3/5.0/6.0/7.0/ 8.0/9.0/10.0/12.0	± 3.0 (Ta=-40 to +105°C)	0.3	0.6	0.6 (Io=300mA)	60 (f=100Hz, 50mVpp, Io=0A)	25 (Io=0 to 300mA)	1.0	1.0	✓	Over-Current/ Temperature	HTSOP-J8

Part No.	Input Voltage (V)	Output Voltage (V)	Output Voltage precision (%)	Output current (A)	Bias current (mA)	Saturation voltage (V)	Ripple Rejection (dB)	Load Regulation (mV)	Input Capacitor (μ F)	Output Capacitor (μ F)	Shutdown Switch	Protection circuit	Package
10V Resistance Output		1.5A LDO Regulators with Shutdown											
BDxxHC5MEFJ-M	4.5 to 8.0	ADJ (1.5 to 7.0)/ 1.5/1.8/2.5/3.0/3.3/ 5.0/6.0/7.0	± 3.0 (Ta=-40 to +105°C)	1.5	0.6	0.6 (Io=1.5A)	60 (f=100Hz, 50mVpp, Io=0A)	25 (Io=0 to 1.5A)	1.0	1.0	✓	Over-Current/ Temperature	HTSOP-J8
10V Resistance Output		1A LDO Regulators with Shutdown											
BDxxHC0MEFJ-M	4.5 to 8.0	ADJ (1.5 to 7.0)/ 1.5/1.8/2.5/3.0/3.3/ 5.0/6.0/7.0	± 3.0 (Ta=-40 to +105°C)	1.0	0.6	0.6 (Io=1A)	60 (f=100Hz, 50mVpp, Io=0A)	25 (Io=0 to 1A)	1.0	1.0	✓	Over-Current/ Temperature	HTSOP-J8
10V Resistance Output		500mA LDO Regulators with Shutdown											
BDxxHA5MEFJ-M	4.5 to 8.0	ADJ (1.5 to 7.0)/ 1.5/1.8/2.5/3.0/3.3/ 5.0/6.0/7.0	± 3.0 (Ta=-40 to +105°C)	0.5	0.6	0.6 (Io=500mA)	60 (f=100Hz, 50mVpp, Io=0A)	25 (Io=0 to 500mA)	1.0	1.0	✓	Over-Current/ Temperature	HTSOP-J8
10V Resistance Output		300mA LDO Regulators with Shutdown											
BDxxHA3MEFJ-M	4.5 to 8.0	ADJ (1.5 to 7.0)/ 1.5/1.8/2.5/3.0/3.3/ 5.0/6.0/7.0	± 3.0 (Ta=-40 to +105°C)	0.3	0.6	0.6 (Io=300mA)	60 (f=100Hz, 50mVpp, Io=0A)	25 (Io=0 to 300mA)	1.0	1.0	✓	Over-Current/ Temperature	HTSOP-J8

Part No.	Input Voltage (V)	Output Voltage (V)	Output Voltage precision (%)	Output current (A)	Bias current (mA)	Saturation voltage (V)	Ripple Rejection (dB)	Load Regulation (mV)	Input Capacitor (μ F)	Output Capacitor (μ F)	Shutdown Switch	Protection circuit	Package
7V Resistance Output		1A LDO Regulators with Shutdown											
BDxxIC0MEFJ-M	2.3 to 5.5/ 2.4 to 5.5	ADJ (0.8 to 4.5)/ 1.0/1.2/1.5/1.8/ 2.5/3.0/3.3	± 3.0 (Ta=-40 to +105°C)	1.0	0.25	0.4 (Io=1A)	60 (f=100Hz, 50mVpp, Io=0A)	25 (Io=0 to 1A)	1.0	1.0	✓	Over-Current/ Temperature	HTSOP-J8
7V Resistance Output		500mA LDO Regulators with Shutdown											
BDxxIA5MEFJ-M	2.3 to 5.5	ADJ (0.8 to 4.5)/ 1.0/1.2/1.5/1.8/ 2.5/3.0/3.3	± 3.0 (Ta=-40 to +105°C)	0.5	0.25	0.4 (Io=500mA)	60 (f=100Hz, 50mVpp, Io=0A)	25 (Io=0 to 500mA)	1.0	1.0	✓	Over-Current/ Temperature	HTSOP-J8

Part No.	Input Voltage (V)	Output Voltage (V)	Output Voltage precision (%)	Output current (A)	Saturation voltage (mV)	Ripple Rejection (dB)	Load Regulation (mV)	Circuit Current (μ A)	Output Short current (mA)	Input Capacitor (μ F)	Output Capacitor (μ F)	Shutdown Switch	Over current protection	Temperature protection	Discharge function	Package
1ch		200mA CMOS LDO Regulators with Shutdown														
New BUxxSD2MG-M	1.7 to 6.0	1.2/1.5/1.8/2.5/ 2.8/3.0/3.3	± 2 (Ta=-40°C to +105°C)	0.2	85 to 400 (Io=100mA)	68	1 (Io=1mA to 200mA)	33	100	1.0	1.0	✓	✓	✓	-	SSOP5

Please ensure that minimum input voltage always exceeds the sum of output voltage and drop out voltage for the device.

Switching Regulators

ROHM offers high-efficiency power supply solutions to suit a variety of customer requirements. Our latest DC/DC converter lineup, the BD9x family of buck converters, supports 3.3V, 5V, 12V, 24V, and 48V power supplies and provides improved efficiency by minimizing the ON-resistance of the internal power MOSFET.

3.3V, 5V Rail Input Solutions Single Synchronous Rectification Buck DC/DC Converter with Built-In MOSFET

BD9B300MUV Under Development

The BD9B300MUV ensures high efficiency across the entire load range, enabling compliance with energy standards.

Key Features

- Input voltage range: 2.7V to 5.5V
- Output voltage range: 0.8V to (V_{IN}×0.8)V
- Reference voltage: 0.8V±1.0%
- Output current: 3A
- Switching frequency: 1MHz / 2MHz
- Built-in switching FET: 35mΩ
- Circuit current: 35μA
- Fast transient response characteristics via constant ON-time control
- High efficiency Light Load Mode
- Selectable automatic Light Load Switching and Fixed PWM modes
- Adjustable Soft Start function
- Power Good Output
- Multiple protection functions
Over Current Protection (OCP), Short Circuit Protection (SCP)
Thermal Shutdown (TSD), Under-Voltage Lock Out (UVLO)

Application Circuit Example

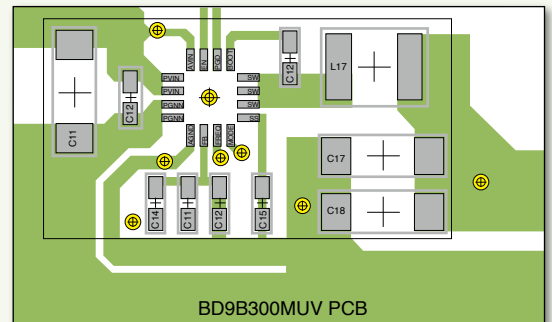
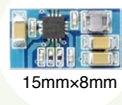
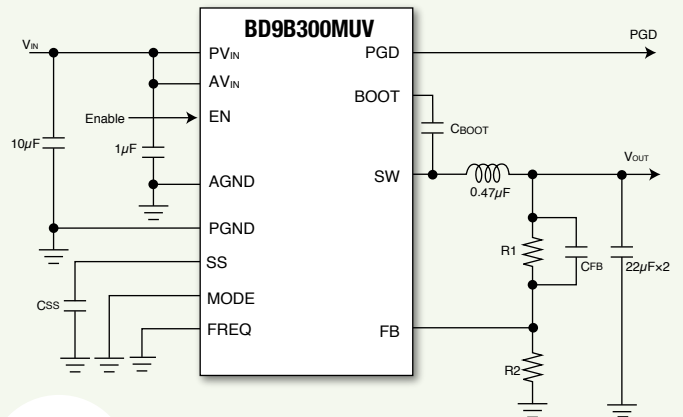

High Efficiency Under All Loads

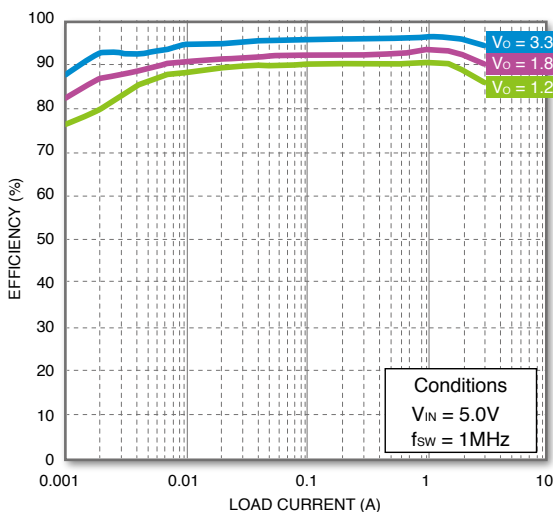

Part No. Explanation

B	D	9	A	3	0	0
Topology		Maximum Input Voltage Rating and Control Mode			Output Current	
9 : Buck		A : ≤ 7V	Current Mode		1 : ≤ 1A	
8 : Boost, Buck-Boost, Inverting		B : ≤ 7V	Hysteresis		2 : ≤ 2A	
		C : ≤ 20V	Current Mode		3 : ≤ 3A	
		D : ≤ 20V	Hysteresis		4 : ≤ 4A	
		E : ≤ 40V	Current Mode		5 : ≤ 5A	
		F : ≤ 40V	Hysteresis		6 : ≤ 6A	
		G : ≤ 80V	Current Mode		: ≤ 10A	
Serial No. 00, 01, ...						

12V Rail Input Solutions Single Synchronous Rectification Buck DC/DC Converters with Built-In MOSFET

BD9D320EFJ/BD9D321EFJ

NEW

Key Features

- Input voltage range: 4.5V to 18V
- Output voltage range: 0.765V to 7.0V
- Reference voltage: 0.765V±1.5%
- Output current: 3A
- Switching frequency: 700kHz
- No external phase compensation required
- High efficiency mode for light loads (BD9D321EFJ)
- Adjustable Soft-Start function

BD9D320EFJ and BD9D321EFJ utilize fixed ON time control for high-speed transient response characteristics.

In addition, the BD9D321EFJ integrates a special mode that improves performance at light loads, ensuring high efficiency across the entire load region.

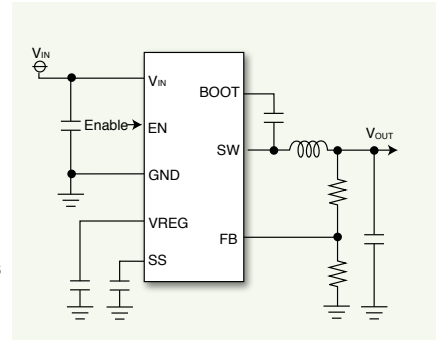

24V Rail Input Solutions Single Synchronous Rectification Buck DC/DC Converters with Built-In MOSFET

BD9E300EFJ-LB/BD9E301EFJ-LB

NEW

Key Features

- Input voltage range: 7.0V to 36V
- Output voltage range: 1.0V to ($V_{IN} \times 0.7$)V
- Reference voltage: 1.0V±2.0%
- Output current: 2.5A
- Switching frequency: 1MHz (BD9E300EFJ)
570kHz (BD9E301EFJ)
- Current mode control
- Soft Start function

BD9E300EFJ-LB and BD9E301EFJ-LB provide superior reliability. In addition, they feature 40V input resistance, and stable, long-term supply is ensured, making them ideal for industrial equipment applications.

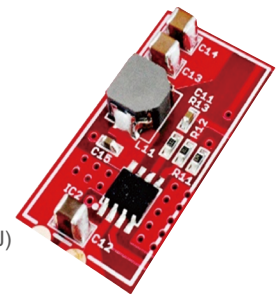

BD9E102FJ

NEW

Key Features

- Input voltage range: 7.0V to 26V
- Output voltage range: 1.0V to ($V_{IN} \times 0.7$)V
- Reference voltage: 0.8V±2.0%
- Output current: 1.0A
- Current mode control
- High efficiency at light loads
- Soft Start function

BD9E102FJ features an input voltage resistance of 28V - required by home appliances and consumer electronics devices. Replacing conventional LDOs with the BD9E102FJ will reduce both power consumption and heat generation, as well as increase efficiency during light loads, making it ideal for applications seeking to minimize standby power consumption.

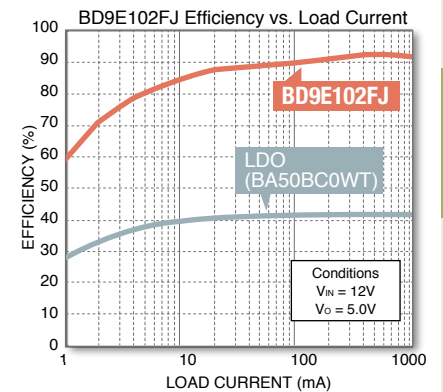

Dual Synchronous Rectification Buck DC/DC Converter with Built-In MOSFET

BD93291EFJ

NEW

Key Features

- Multiple protection circuits
Overcurrent Protection (OCP),
Thermal Shutdown (TSD),
Undervoltage Lock Out (UVLO)
- Soft start function

The BD93291EFJ integrates 2 synchronous rectification buck DC/DC converters in a compact 8-pin package for increased space savings.

Parameter	High Voltage (V_{OUT1})	Low Voltage (V_{OUT2})
Input Voltage Range	8.0V to 26V	5.0V (V_{OUT1} output voltage used)
Output Voltage Range	5.0V±1.5%	0.8V to 4.0V
Reference Voltage	-	0.8V±1.5%
Output Current	2.5A	1.5A
Switching Frequency	300kHz to 600kHz	1.5MHz to 2.5MHz
MOSFET ON Resistance	175mΩ / 175mΩ (Typ.) (High Side) (Low Side)	250mΩ, 250mΩ (Typ.) (High Side) (Low Side)

Key Features

- Multiple protection circuits
Overcurrent Protection (OCP),
Thermal Shutdown (TSD),
Undervoltage Lock Out (UVLO)
- Soft start function

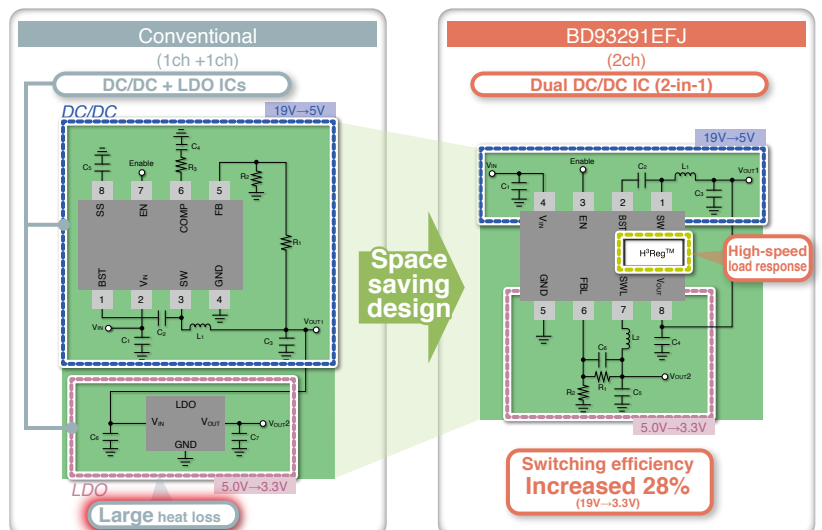

New Switching Regulators BD9x Family

The BD9x family includes different rectification and control methods and features improved efficiency at light loads. Both synchronous and non-synchronous (diode) rectification are supported. Typically, non-synchronous rectification can achieve a smaller footprint, since the diode is externally used for low-side switch, but efficiency is reduced if the output voltage is low. However, at high output voltages efficiency is similar to that of synchronous rectification. In contrast, synchronous rectification can minimize efficiency reduction at all output voltage levels, and ensure stable operation even when load current changes.

Two types of rectification control methods are available: Current-mode and Hysteresis control. Current-mode has a faster transient response than conventional Voltage-mode control, enables easier phase compensation, and features smaller output ripple voltage. On the other hand, Hysteresis control (also known as on-time or H³Reg™ control mode) provides faster transient response than Current-mode control and doesn't require phase compensation.

ICs that integrate a special improved efficiency mode for light loads can save power while on standby and reduce switching frequency when load current decreases. This minimizes operating current, improving efficiency. However, customers should consider the possible increase in signal interference and output ripple voltage that may occur, and determine whether they are suitable based on specifications and application requirements.

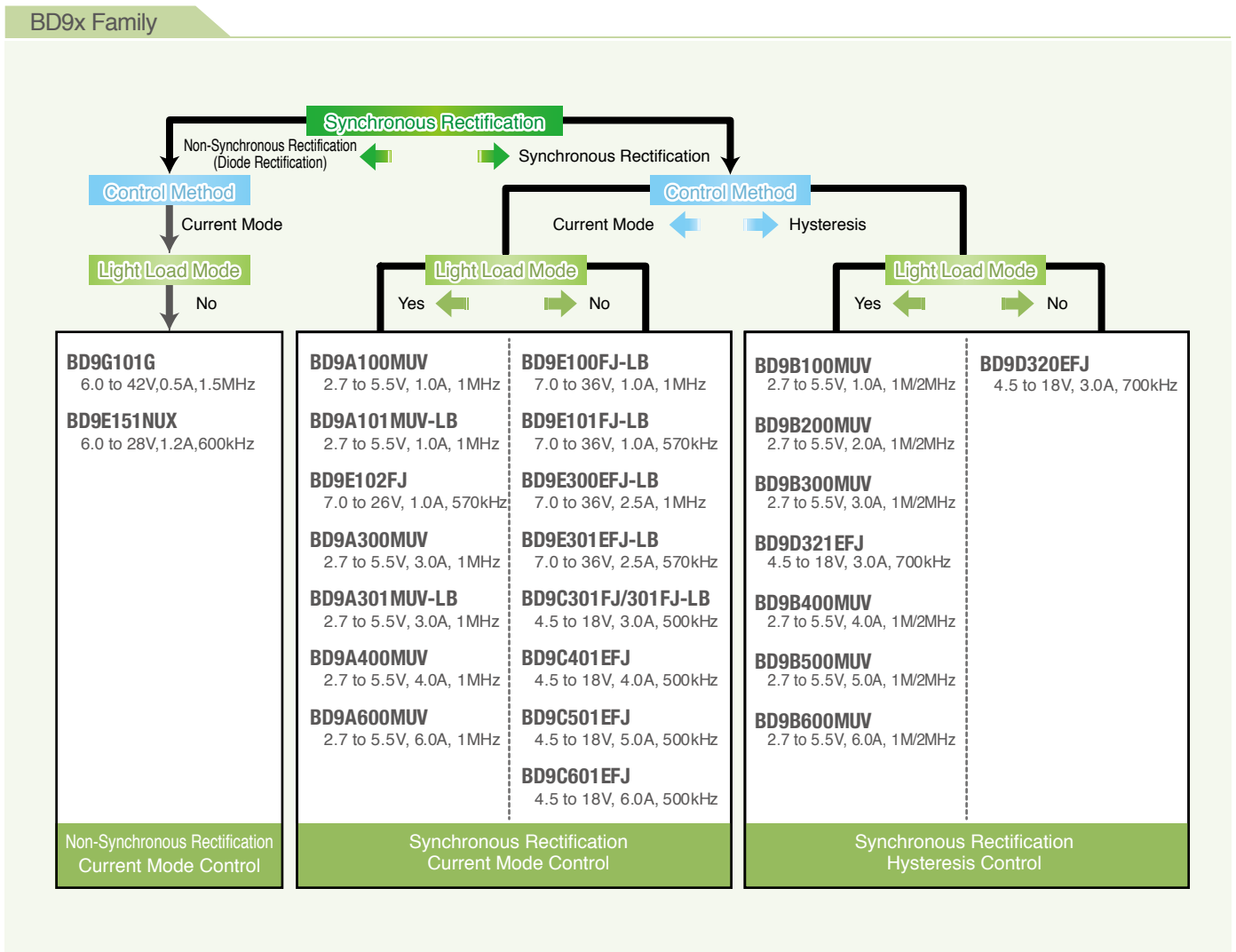

Thin, Compact Packages

The Exposed-pad enables efficient heat dissipation from the bottom of the package to the PCB. This enables to implement 6A DC/DC solution with a compact package.

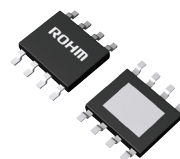

HTSOP-J8
4.90mm×6.00mm h: 1.00mm

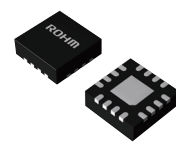

VQFN016V3030
3.00mm×3.00mm h: 1.00mm

Buck Switching Regulator Selection Chart

▲ Non-synchronous ■ External synchronization ➡ Maximum Rating PWM Mode
 ◎ H³Reg™ Control ○ Hysteresis Control PGD : Power Good Output Adj.SS : Adjustable Soft-Start Light Load Mode

Features (Unless otherwise specified)
 • Soft Start • Synchronous Rectification
 • Enable • Current Mode control

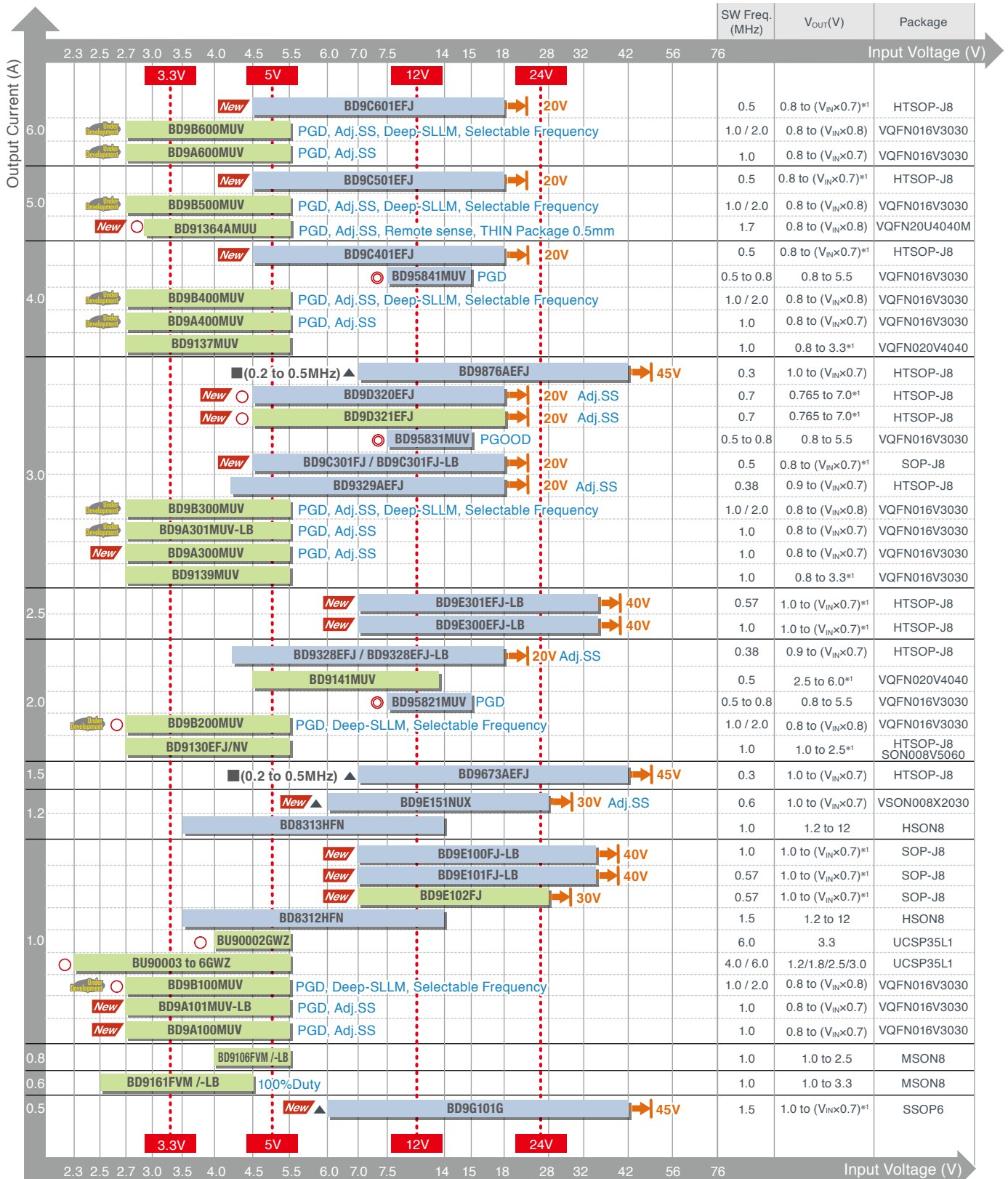

*1: Limited by conditions

Power Management Switch ICs

1ch Variable Overcurrent Detection Threshold

BD2242G/BD2243G

NEW

BD2242G and BD2243G are power supply protection ICs ideal for external power supply terminals such as USB.

The overcurrent detection threshold can be arbitrarily set via external resistor, making it possible to flexibly respond to specification changes and the use of common parts/designs.

Key Features

- Input voltage range: 2.8V to 5.5V
- Variable overcurrent detection range: 0.2A to 1.7A
- High accuracy overcurrent detection: $\pm 7.7\%$ (1.7A setting, $R_{LIM}=12k\Omega$)
- Low ON resistance: 89m Ω
- Output Enable (H Active: BD2242G, L Active: BD2243G)
- Multiple protection functions: overcurrent (OCP), thermal shutdown (TSD), undervoltage lockout (UVLO), soft start

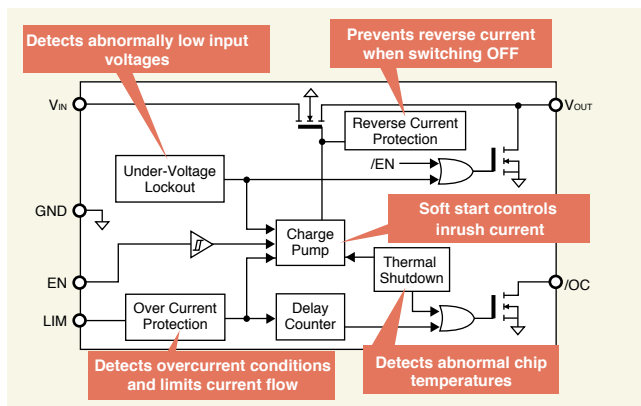

Current Limiting Resistor vs. Current Limit Threshold

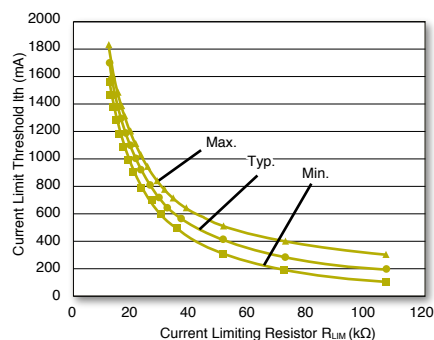

Ultra-Compact Load Switches

BUS1DJC0GWZ/BUS1DJC3GWZ

NEW

The BUS1DJC0GWZ and BUS1DJC3GWZ integrate power supply switching circuitry into an ultra-compact WL-CSP, simplifying power system management while contributing greater miniaturization. In addition short-circuit protection and soft start operation provide greater reliability.

Key Features

- Input voltage range: 1.1V to 5.0V
- Max. current: 2.0A
- Low ON resistance: 63m Ω ($V_{IN}=3.3V$)
- Low current consumption: 0.35 μA ($V_{IN}=3.3V$)
- Integrated soft start function: 510 μs ($V_{IN}=1.2V$) [BUS1DJC3GWZ]
- Built-in output discharge function
- Short-circuit protection

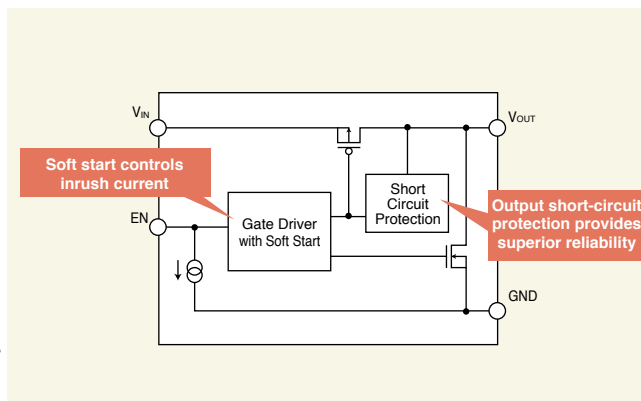

Output Short Circuit Protection Characteristics

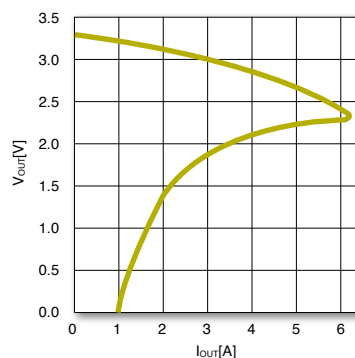

Power Management Switch

1 Channel Compact		High Side Switch ICs							
Part No.	Input voltage range (V)	Current consumption (μA)	ON resistance (mΩ)	Number of output channel	Control input logic	Over current detection Min./Typ./Max. (A)	Over current detection (ms)	Flag output delay (ms)	Package
BD2248G	2.7 to 5.5	130	110	1 ch	H Active	0.2/0.3/0.4	1.0	15	SSOP5
BD2246G	2.7 to 5.5	110	110	1 ch	H Active	0.63/0.765/0.9	1.0	15	SSOP5
BD2247G	2.7 to 5.5	110	110	1 ch	L Active	0.63/0.765/0.9	1.0	15	SSOP5
BD2240G	2.7 to 5.5	110	110	1 ch	H Active	0.82/0.97/1.12	1.0	15	SSOP5
BD2241G	2.7 to 5.5	110	110	1 ch	L Active	0.82/0.97/1.12	1.0	15	SSOP5
BD2232G	2.7 to 5.5	110	100	1 ch	H Active	1.15/1.275/1.4	1.0	15	SSOP5
BD2233G	2.7 to 5.5	110	100	1 ch	L Active	1.15/1.275/1.4	1.0	15	SSOP5
New BD2242G	2.8 to 5.5	120	89	1 ch	H Active	0.2 to 1.7(adjustable)	0.6	7	SSOP6
New BD2243G	2.8 to 5.5	120	89	1 ch	L Active	0.2 to 1.7(adjustable)	0.6	7	SSOP6

1 Channel		High Side Switch ICs							
Part No.	Input voltage range (V)	Current consumption (μA)	ON resistance (mΩ)	Number of output channel	Control input logic	Over current detection Min./Typ./Max. (A)	Over current detection (ms)	Flag output delay (ms)	Package
BD82020FVJ	2.8 to 5.5	95	90	1 ch	H Active	1.1 / 1.5 / 2.0	0.4	12	TSSOP-B8J
BD82021FVJ	2.8 to 5.5	95	90	1 ch	L Active	1.1 / 1.5 / 2.0	0.4	12	TSSOP-B8J
BD82022FVJ	2.8 to 5.5	95	90	1 ch	H Active	1.5 / 2.0 / 2.6	0.4	12	TSSOP-B8J
BD82023FVJ	2.8 to 5.5	95	90	1 ch	L Active	1.5 / 2.0 / 2.6	0.4	12	TSSOP-B8J
BD82024FVJ	2.8 to 5.5	95	90	1 ch	H Active	2.1 / 2.5 / 3.3	0.4	12	TSSOP-B8J
BD82025FVJ	2.8 to 5.5	95	90	1 ch	L Active	2.1 / 2.5 / 3.3	0.4	12	TSSOP-B8J
BD82028FVJ	4.5 to 5.5	85	72	1 ch	H Active	0.6 / 1.0 / 1.2	0.3	13	TSSOP-B8J
BD82029FVJ	4.5 to 5.5	85	72	1 ch	L Active	0.6 / 1.0 / 1.2	0.3	13	TSSOP-B8J
BD82030FVJ	4.5 to 5.5	85	72	1 ch	H Active	1.05 / 1.5 / 1.8	0.3	13	TSSOP-B8J
BD82031FVJ	4.5 to 5.5	85	72	1 ch	L Active	1.05 / 1.5 / 1.8	0.3	13	TSSOP-B8J
BD82032FVJ	4.5 to 5.5	85	72	1 ch	H Active	1.55 / 2.0 / 2.3	0.3	13	TSSOP-B8J
BD82033FVJ	4.5 to 5.5	85	72	1 ch	L Active	1.55 / 2.0 / 2.3	0.3	13	TSSOP-B8J
BD82034FVJ	4.5 to 5.5	85	72	1 ch	H Active	2.05 / 2.5 / 2.8	0.3	13	TSSOP-B8J
BD82035FVJ	4.5 to 5.5	85	72	1 ch	L Active	2.05 / 2.5 / 2.8	0.3	13	TSSOP-B8J

1 Channel Compact		High Side Switch ICs			Automotive				
Part No.	Input voltage range (V)	Current consumption (μA)	ON resistance (mΩ)	Number of output channel	Control input logic	Over current detection Min./Typ./Max. (A)	Over current detection (ms)	Flag output delay (ms)	Package
☆ BD2262G-M	2.7 to 5.5	110	120	1 ch	H Active	0.2/0.3/0.4	1.0	15	SSOP5
☆ BD2264G-M	2.7 to 5.5	110	120	1 ch	H Active	0.63/0.765/0.9	1.0	15	SSOP5
☆ BD2265G-M	2.7 to 5.5	110	120	1 ch	L Active	0.63/0.765/0.9	1.0	15	SSOP5
☆ BD2266G-M	2.7 to 5.5	110	120	1 ch	H Active	0.82/0.97/1.12	1.0	15	SSOP5
☆ BD2267G-M	2.7 to 5.5	110	120	1 ch	L Active	0.82/0.97/1.12	1.0	15	SSOP5

☆ Under development

1 Channel		Load Switch ICs							
Part No.	Input voltage range (V)	Current consumption (μA)	ON resistance (mΩ)	Number of output channel	Control input logic	Output current (A)	Over current detection (μs)	Discharge resistance (Ω)	Package (mm)
New BUS1DJC0GWZ	1.1 to 5.0	0.35	63	1 ch	H Active	2.0	32 (V _{IN} =1.2V) 12 (V _{IN} =3.3V)	80	UCSP30L1 (0.8x1.0x0.35)
☆ BUS1DJC3GWZ	1.1 to 5.0	0.35	63	1 ch	H Active	2.0	510 (V _{IN} =1.2V) 190 (V _{IN} =3.3V)	80	UCSP30L1 (0.8x1.0x0.35)
BD6529GUL	2.7 to 4.5 0 to 2.7(SW Voltage range)	20	100	1 ch	H Active	0.5	500	70	VCSP50L1 (1.5x1.0x0.55)
BD2200GUL	2.7 to 5.5	20	100	1 ch	H Active	0.5	1000	70	VCSP50L1 (1.5x1.0x0.55)
BD2201GUL	2.7 to 5.5	20	100	1 ch	H Active	1	1000	70	VCSP50L1 (1.5x1.0x0.55)

☆ Under Development

2 Channel		Load Switch ICs							
Part No.	Switch voltage range (V)	Input voltage range (V)	ON resistance (mΩ)	Number of output channel	Control input logic	Output current (A)	Over current detection (μs)	Discharge resistance (Ω)	Package (mm)
BDS2DJ22GUL	1.0 to 3.6	3.0 to 3.6	45	2 ch	H Active	0.2	440 (V _{IN} =1.8V) 600 (V _{IN} =3.3V)	30	VCSP50L1 (1.95x1.0x0.55)
New BDS2DJAAGUL	1.0 to 3.6	3.0 to 3.6	45	2 ch	H Active	1.0	440 (V _{IN} =1.8V) 600 (V _{IN} =3.3V)	30	VCSP50L1 (1.95x1.0x0.55)

AD/DA Converter ICs

AD Converter ICs

Automotive-Grade AEC-Q100-Compliant Successive-Approximation-Type AD Converters Guaranteed up to +105°C

BU1S12S0xxx-M Under Development

Key Features

- Supply voltage range: 2.7V to 5.25V
- Sampling rate: 50K to 1MSPS
- Low power consumption
 - 1MSPS operation : 8mW @ $V_A=5V$ (Typ.)
 - 1.5mW @ $V_A=3V$ (Typ.)
 - Power down : 0.5 μ W @ $V_A=5V$ (Typ.)
- Operating temp. range: -40°C to +105°C
- AEC-Q100-compliant
- Interface: SPI
- INL: -1.1 to +1.0 LSB
- DNL: -0.9 to +1.0 LSB
- SNR: 71.5dB @ $V_A=3V$ (Typ.)
- SINAD: 71.0dB @ $V_A=3V$ (Typ.)

Application Block Diagram

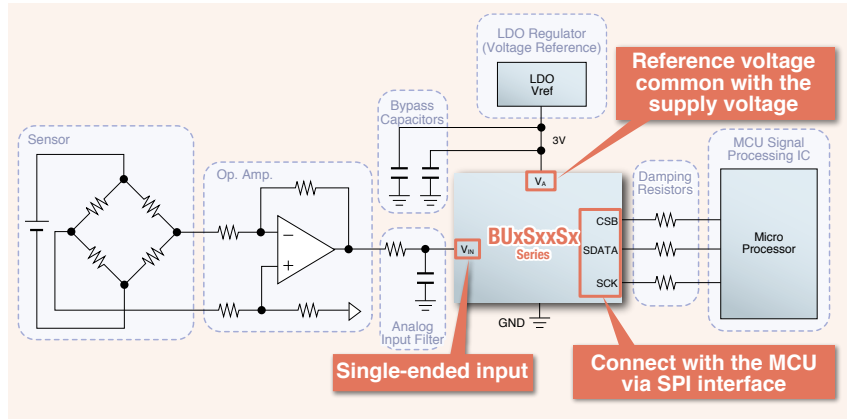

12bit		AD Converter ICs						
Part No.	Supply voltage (V)	CH	Analog Input type	Sampling frequency (SPS)	DNL (LSB)	INL (LSB)	Interface	Package
☆ BU1S12S0xxx-M	2.7 to 5.25	1	Single ended	50K to 1M	-0.9 to +1.0	-1.1 to +1.0	SPI	SSOP6/MSOP8
☆ BU2S12S0FVJ-M	2.7 to 5.25	2	Single ended	50K to 1M	-0.9 to +1.0	-1.1 to +1.0	SPI	TSSOP-B8J
☆ BU4S12S0FUJ-M	2.7 to 5.25	4	Single ended	50K to 1M	-0.9 to +1.0	-1.1 to +1.0	SPI	TSSOP-C10J

☆ Under development

10bit		AD Converter ICs						
Part No.	Supply voltage (V)	CH	Analog Input type	Sampling frequency (SPS)	DNL (LSB)	INL (LSB)	Interface	Package
BH2715FV	2.7 to 5.25	8	Single ended	50K to 220K	±1.2	±1.5	SPI	SSOP-B16
☆ BU1S10S0G-M	2.7 to 5.25	1	Single ended	50K to 1M	±0.7	±0.7	SPI	SSOP6

☆ Under development

8bit		AD Converter ICs						
Part No.	Supply voltage (V)	CH	Analog Input type	Sampling frequency (SPS)	DNL (LSB)	INL (LSB)	Interface	Package
☆ BU1S08S0G-M	2.7 to 5.25	1	Single ended	50K to 1M	±0.3	±0.3	SPI	SSOP6

☆ Under development

M-grade products are designed for car navigation and audio systems.

DA Converter ICs

8bit		DA Converter ICs									
Part No.	Supply voltage (V)	CH	Current consumption (mA)	DNL (LSB)	INL (LSB)	IL (mA)	Settling time (μ s)	Data transmit (MHz)	Input type	Data latch method	Package
BH2219FVM	2.7 to 5.5	2	0.4	±1.0	±1.5	±1.0	100	10	CMOS	LD	MSOP8
BH2220FVM	2.7 to 5.5	3	0.4	±1.0	±1.5	±1.0	100	10	CMOS	LD	MSOP8
BH2227FV	2.7 to 5.5	4	0.8	±1.0	±1.5	±1.0	100	10	CMOS	CSB	SSOP-B14
BH2228FV	2.7 to 5.5	6	0.8	±1.0	±1.5	±1.0	100	10	CMOS	CSB	SSOP-B14
BH2226FV	2.7 to 5.5	8	1.1	±1.0	±1.5	±1.0	100	10	CMOS	CSB	SSOP-B16
BH2226F	2.7 to 5.5	8	1.1	±1.0	±1.5	±1.0	100	10	CMOS	CSB	SOP16
BH2223FV	2.7 to 5.5	10	1.1	±1.0	±1.5	±1.0	100	10	CMOS	LD	SSOP-B16
BH2221FV	2.7 to 5.5	12	1.6	±1.0	±1.5	±1.0	100	10	CMOS	LD	SSOP-B20

10bit		DA Converter ICs									
Part No.	Supply voltage (V)	CH	Current consumption (mA)	DNL (LSB)	INL (LSB)	IL (mA)	Settling time (μ s)	Data transmit (MHz)	Input type	Data latch method	Package
BU2508FV	4.5 to 5.5	4	4.5	±1.0	±3.5	±2.0	20	10	TTL	LD	SSOP-B14
BU2507FV	4.5 to 5.5	6	4.5	±1.0	±3.5	±2.0	20	10	TTL	LD	SSOP-B14
BU2506FV	4.5 to 5.5	8	4.5	±1.0	±3.5	±2.0	20	10	TTL	LD	SSOP-B20
BU2505FV	4.5 to 5.5	10	4.5	±1.0	±3.5	±2.0	20	10	TTL	LD	SSOP-B20

Real Time Clocks (RTCs)

BU9873 Series

Real Time Clocks are ICs that provide clock and calendar functionality.

ROHM RTCs feature greater compactness, lower power consumption, and serial I/F for communicating with host devices.

They are designed for applications requiring clock operation, including AV devices, communication/OA equipment, PCs, home appliances, and meters.

Key Features

- Communicates via I²C interface
- Time function (hours/minutes/seconds)
- Calendar function (year/month/date/day)
- Interrupt function
- Built-in high-accuracy digital clock error correction circuit
- Alarm function
- Oscillation stop detection
- 32.768kHz clock output
- Automatic leap year discrimination
- Integrated oscillation stabilization capacitors (C_G, C_D)

Packages

W (Typ.) x D (Typ.) x H (Max.)

Typical Application Circuits

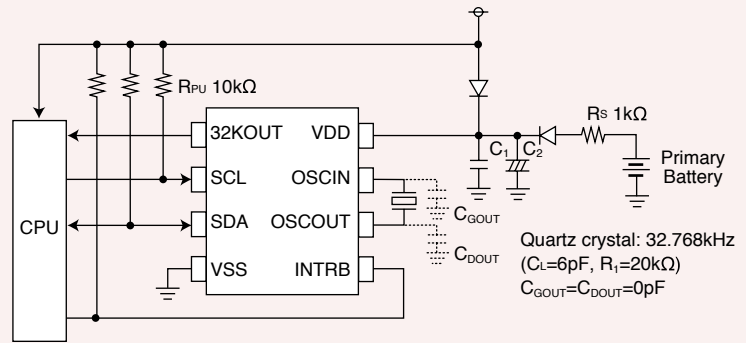
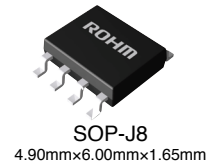

(When using primary battery)

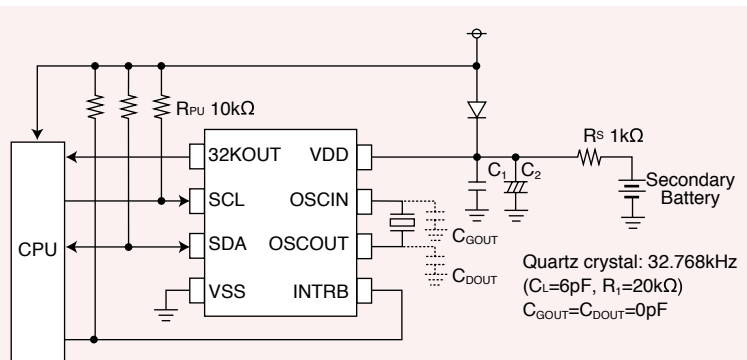

(When using secondary battery)

Real Time Clock ICs

Part No.	I/F	Voltage (V)	Time keeping Voltage (V)	Time keeping current (Typ.) (μA)	Time keeping current (Max.) (μA)	Access frequency 1 (Max.) (kHz)	Access frequency 2 (Max.) (kHz)	Package
BU9873F	I ² C	1.8 to 5.5	1.45 to 5.5	0.4 (V _{DD} =3V, T _a =25°C)	1.0 (V _{DD} =3V, T _a =40°C to 85°C)	100 (V _{DD} =1.8V to 2.5V)	400 (V _{DD} =2.5V to 5.5V)	SOP8
BU9873FJ								SOP-J8
BU9873FVM								MSOP8
BU9873FVT								TSSOP-B8
BU9873NUX								VSON008X2030

Transistor Arrays / Standard Logic

Darlington Transistor Arrays

Open Collector		Darlington Transistor Arrays									
Part No.	Number of bit	Output Withstand Voltage (V)	Output Saturation Voltage(V)	Output Current(mA)	Input Resistance(kΩ)	Input/output relation	Input Active Level	Input/output relation	Circuit Construction	Features	Package
BA12003B	7	60	1.46*	500	2.7	Inverting type	H	Sink	Darlington	Built-in surge absorbing diode	DIP16
BA12003BF	7	60	1.46*	500	2.7	Inverting type	H	Sink	Darlington	Built-in surge absorbing diode	SOP16
BA12004B	7	60	1.46*	500	10.5	Inverting type	H	Sink	Darlington	Built-in surge absorbing diode	DIP16
BA12004BF	7	60	1.46*	500	10.5	Inverting type	H	Sink	Darlington	Built-in surge absorbing diode	SOP16

* Output Current=350mA

Standard Logic

Analog Switch / Analog Switch (Single type)				Standard Logic								
Type	Part No.			Function	Supply voltage (V)	H Input Voltage (V)	L Input Voltage (V)	ON resistance (Ω)	Control-output propagation delay time (ns)	IN-Out propagation delay time (ns)	Max. propagation Frequency (MHz)	
	DIP16(14)	SOP16(14)	SSOP-B16(14)									SSOP5
BU4066BC	BU4066BC	BU4066BCF	BU4066BCFV	Quad Analog Switch	3 to 18	3.5(Min.)	1.5(Max.)	950(Max.)	60(Typ.)	20(Typ.)	-	
BU4S66	-	-	BU4S66G2	Single Analog Switch	3 to 16	3.5(Min.)	1.5(Max.)	950(Max.)	80(Typ.)	15(Typ.)	-	

Multiplexer			Standard Logic								
Type	Part No.			Function	Supply Voltage (V)	H Input Voltage (V)	L Input Voltage (V)	ON Resistance (Ω)	Control-output propagation delay time (ns)	IN-Out propagation delay time (ns)	Max. propagation Frequency (MHz)
	DIP16(14)	SOP16(14)	SSOP-B16(14)								
BU4051BC	BU4051BC	BU4051BCF	BU4051BCFV	Analog Multiplexer/ Demultiplexer(8 ⇄ 1)	3 to 18	3.5(Min.)	1.5(Max.)	950(Max.)	170(Typ.)	15(Typ.)	20(Typ.)
BU4052BC	BU4052BC	BU4052BCF	BU4052BCFV	Dual Analog Multiplexer/ Demultiplexer(4 ⇄ 1)	3 to 18	3.5(Min.)	1.5(Max.)	950(Max.)	170(Typ.)	15(Typ.)	20(Typ.)
BU4053BC	BU4053BC	BU4053BCF	BU4053BCFV	Triple Analog Multiplexer/ Demultiplexer(2 ⇄ 1)	3 to 18	3.5(Min.)	1.5(Max.)	950(Max.)	170(Typ.)	15(Typ.)	20(Typ.)
BU4551B	BU4551B	BU4551BF	BU4551BFV	Quad Analog Multiplexer/ Demultiplexer(2 ⇄ 1)	3 to 16	3.5(Min.)	1.5(Max.)	1100(Max.)	360(Typ.)	35(Typ.)	15(Typ.)

Logic Gates			Standard Logic								
Type	Part No.			Function	Supply Voltage (V)	H Input Voltage (V)	L Input Voltage (V)	Hysteresis voltage (V)	H Output Voltage I _{loutl} =0mA(V)	L Output Voltage I _{loutl} =0mA(V)	Propagation delay time (ns)
	DIP14	SOP14	SSOP-B14								
BU4001B	BU4001B	BU4001BF	-	Quad 2-Input NOR Gate	3 to 16	3.5(Min.)	1.5(Max.)	-	4.95(Min.)	0.05(Max.)	90(Typ.)
BU4011B	BU4011B	BU4011BF	BU4011BFV	Quad 2-Input NAND Gate	3 to 16	3.5(Min.)	1.5(Max.)	-	4.95(Min.)	0.05(Max.)	90(Typ.)
BU4030B	BU4030B	BU4030BF	-	Quad Exclusive OR Gate	3 to 16	3.5(Min.)	1.5(Max.)	-	4.95(Min.)	0.05(Max.)	90(Typ.)
BU4070B	BU4070B	BU4070BF	-	Quad Exclusive OR Gate	3 to 16	3.5(Min.)	1.5(Max.)	-	4.95(Min.)	0.05(Max.)	90(Typ.)
BU4081B	BU4081B	BU4081BF	BU4081BFV	Quad 2-Input AND Gate	3 to 16	3.5(Min.)	1.5(Max.)	-	4.95(Min.)	0.05(Max.)	160(Typ.)
BU4093B	BU4093B	BU4093BF	BU4093BFV	Quad 2-Input NAND Schmitt Trigger	3 to 16	3.5(Min.)	1.5(Max.)	0.17 to 0.39	4.95(Min.)	0.05(Max.)	125(Typ.)
BU4069UB	BU4069UB	BU4069UBF	BU4069UBFV	Hex Unbuffer Inverter	3 to 16	4.0(Min.)	1.0(Max.)	-	4.95(Min.)	0.05(Max.)	90(Typ.)
BU4584B	BU4584B	BU4584BF	BU4584BFV	Hex Schmitt Trigger	3 to 16	3.5(Min.)	1.5(Max.)	0.15 to 0.6	4.95(Min.)	0.05(Max.)	125(Typ.)

Logic Gates (Single type)			Standard Logic								
Type	Part No.	Function	Supply Voltage (V)	H Input Voltage (V)	L Input Voltage (V)	Hysteresis voltage (V)	H Output Voltage I _{loutl} <1μA(V)	L Output Voltage I _{loutl} <1μA(V)	Propagation delay time (ns)		
	SSOP5										
BU4S01	BU4S01G2	Single NOR Gate	3 to 16	3.5(Min.)	1.5(Max.)	-	4.95(Min.)	0.05(Max.)	85(Typ.)		
BU4S11	BU4S11G2	Single NAND Gate	3 to 16	3.5(Min.)	1.5(Max.)	-	4.95(Min.)	0.05(Max.)	85(Typ.)		
BU4SU69	BU4SU69G2	Single Unbuffer Inverter	3 to 16	4.0(Min.)	1.0(Max.)	-	4.95(Min.)	0.05(Max.)	55(Typ.)		
BU4S71	BU4S71G2	Single OR Gate	3 to 16	3.5(Min.)	1.5(Max.)	-	4.95(Min.)	0.05(Max.)	90(Typ.)		
BU4S81	BU4S81G2	Single AND Gate	3 to 16	3.5(Min.)	1.5(Max.)	-	4.95(Min.)	0.05(Max.)	90(Typ.)		
BU4S584	BU4S584G2	Single Schmitt Trigger	3 to 16	3.5(Min.)	1.5(Max.)	0.15 to 0.6	4.95(Min.)	0.05(Max.)	125(Typ.)		

Function Logic			Standard Logic										
Type	Part No.			Function	Supply Voltage (V)	H Input Voltage (V)	L Input Voltage (V)	H Output Voltage I _{loutl} =0mA(V)	L Output Voltage I _{loutl} =0mA(V)	Propagation delay time (ns)	Max. clock frequency (MHz)	Set up time (ns)	Hold time (ns)
	DIP16	SOP16	SSOP-B16										
BU4015B	BU4015B	BU4015BF	-	Dual 4-bit Static Shift Register	3 to 16	3.5(Min.)	1.5(Max.)	4.95(Min.)	0.05(Max.)	460(Typ.)	2(Typ.)	100(Typ.)	-
BU4021B	-	BU4021BF	-	8-Stage Static Shift Register	3 to 16	3.5(Min.)	1.5(Max.)	4.95(Min.)	0.05(Max.)	400(Typ.)	3(Typ.)	150(Typ.)	-
BU4094BC	BU4094BC	BU4094BCF	BU4094BCFV	8-Stage Shift/Store Register(3-State)	3 to 18	3.5(Min.)	1.5(Max.)	4.95(Min.)	0.05(Max.)	420(Typ.)	2.5(Typ.)	20(Typ.)	10(Typ.)
Type	Part No.	Function		Supply Voltage (V)	H Input Voltage (V)	L Input Voltage (V)	H Output Voltage I _{loutl} =0mA(V)	L Output Voltage I _{loutl} =0mA(V)	Propagation delay time (ns)	Minimum input pulse width (ns)	Output pulse width (μs)		
BU4538B	BU4538B	Dual High Precision Monostable Multivibrator		3 to 16	3.5(Min.)	1.5(Max.)	4.95(Min.)	0.05(Max.)	300(Typ.)	50(Typ.)	200(Typ.)		
Type	Part No.	Function		Supply Voltage (V)	H Input Voltage (V)	L Input Voltage (V)	H Output Voltage I _{loutl} =0mA(V)	L Output Voltage I _{loutl} =0mA(V)	L to H repagation delay time (ns)	H to L repagation delay time (ns)	Input capacitance (pF)		
BU4028B	BU4028B	BCD to Decimal Decoder		3 to 16	3.5(Min.)	1.5(Max.)	4.95(Min.)	0.05(Max.)	300(Typ.)	300(Typ.)	5(Typ.)		

Access Our Website

www.rohm.com

IC Packages

■ SOP Package

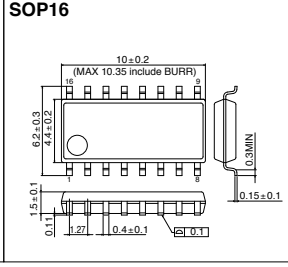
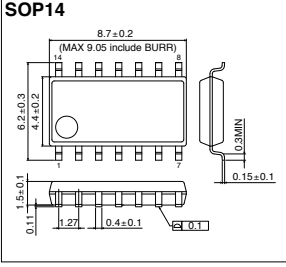
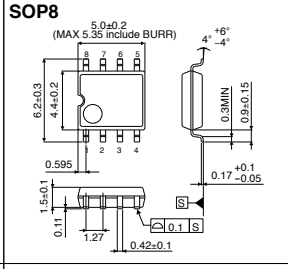
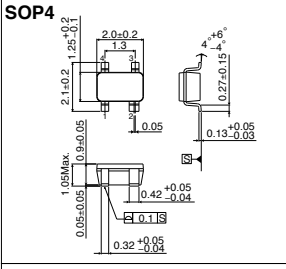

■ SSOP-B Package

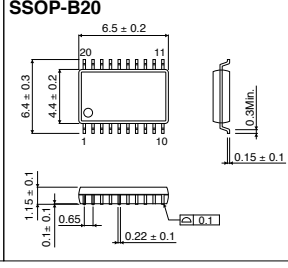
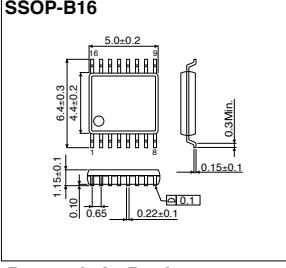
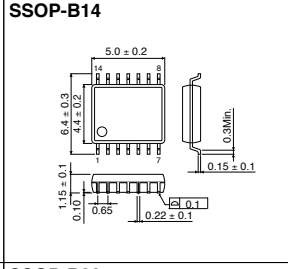
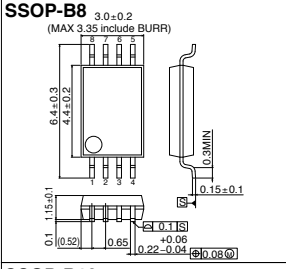

■ Power 3pin Package

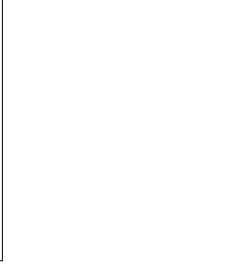
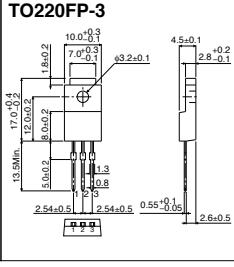
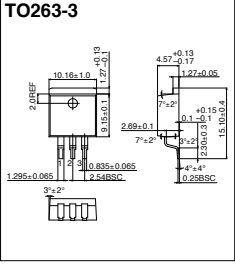
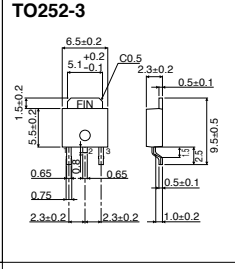
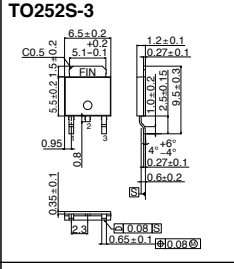
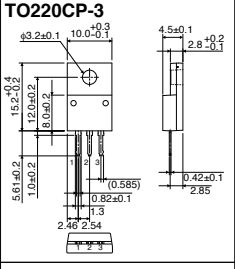

■ Power 4pin Package

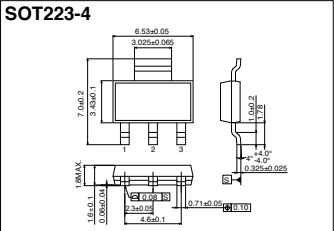

■ HTSOP-J Package

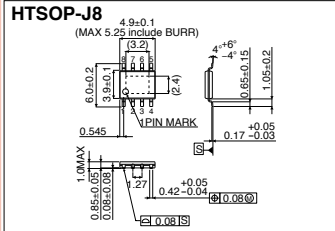

■ JEDEC Package

(Unit: mm)

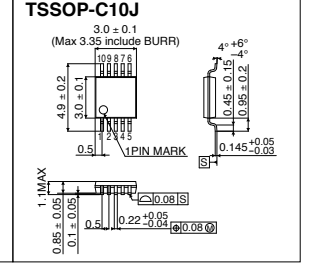
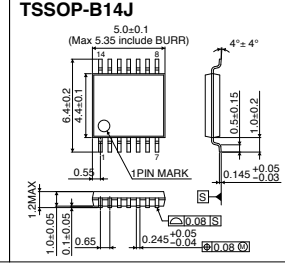
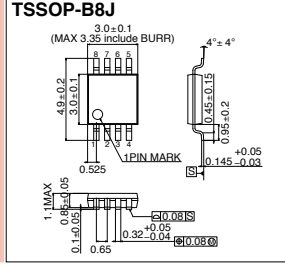
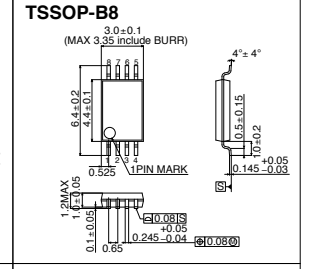
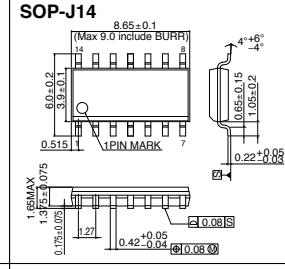
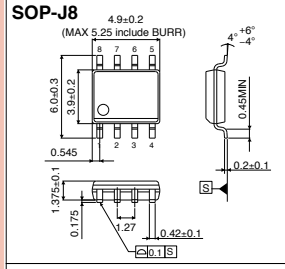

■ Small Package

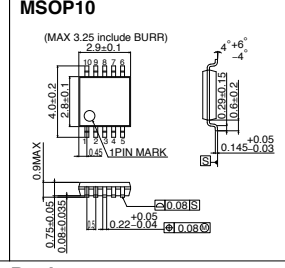
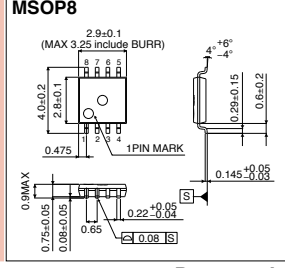
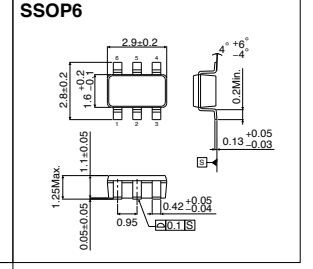
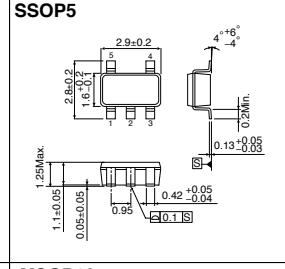
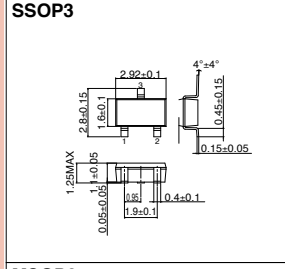

■ Power 5pin Package

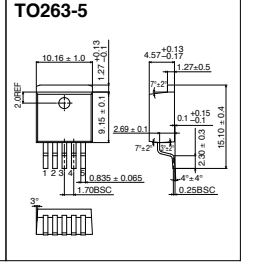
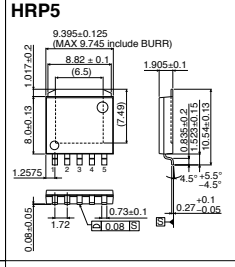
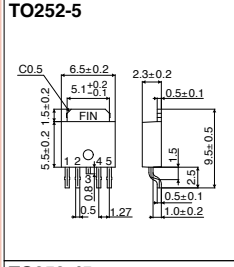
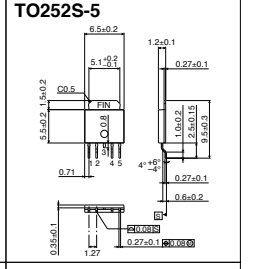
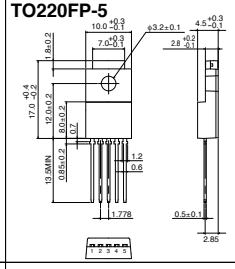
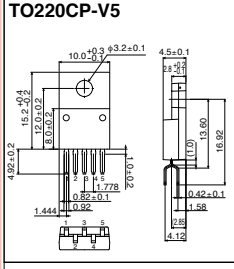

■ Power 4pin Package

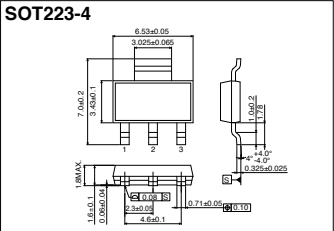

■ HTSOP-J Package

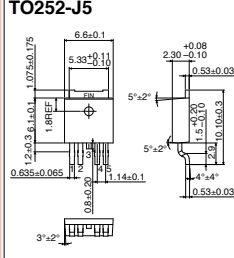
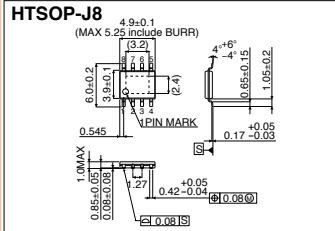

Custom Package(UCSP Package)

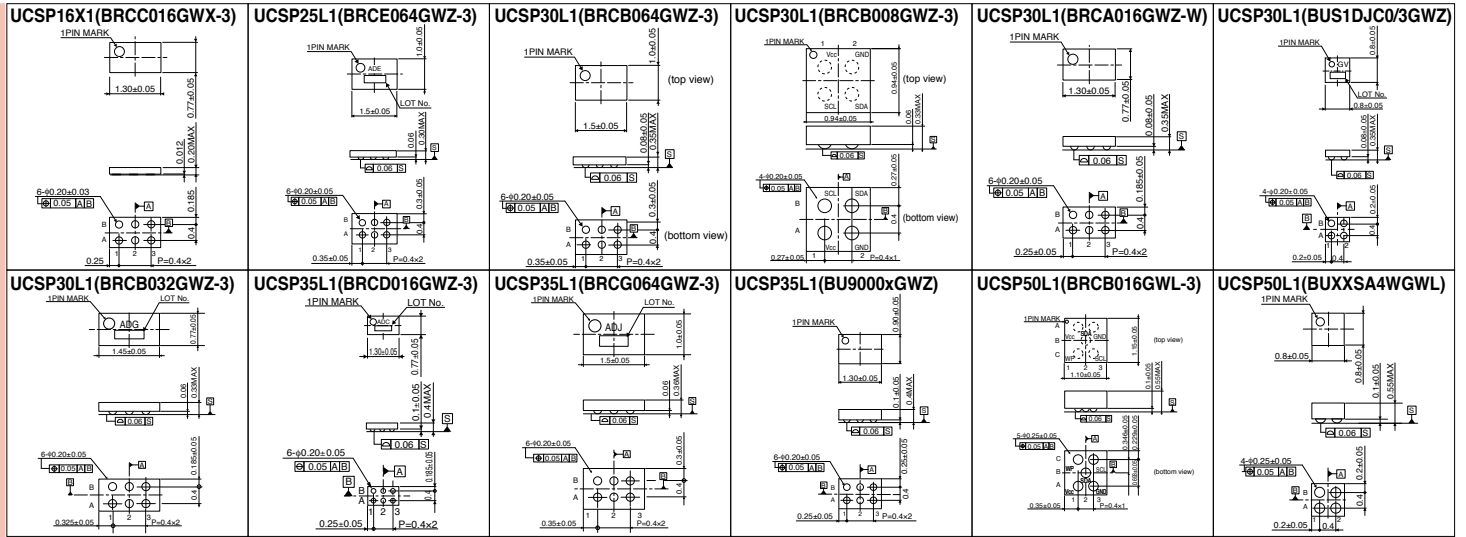

Package Ordering Units

Embossed tape packaging <Package specification name : E2(E1)>

Package ordering unit quantity	Non - Lead Gull Wing Packages	SOP Packages	Power Packages
5,000	*SSON004X1216 SSON004X1010	-	-
3,000	*SOP4, *SSOP5/6, *VSOF5, *HVSOF5/6, *MSOP8, MSOP10, *HSON8, *VSON008V2030, VSON008X2030, VQFN016X3030, VQFN016V3030, WL-CSP (2.8mm ² and under)	TSSOP-B8	-
2,500	VQFN020V4040, WL-CSP (over 2.81mm ²)	SOP8/14/16, TSSOP-C10J, TSSOP-B14J SSOP-B8/14/16/20, SOP-J8/14, HTSSOP-B20/28, HTSSOP-J8, TSSOP-B8J, HTSSOP-B8J,	-
2,000	-	-	*HRP5, TO252S-3/5, SOT223-4
500	-	-	TO220CP-3/V5, TO263-3/5

1) *:Package specification : TR(TL) 2) Specification differ by package size of WL-CSP 3) WL-CSP Package Specification : E2 (standard)

Part No. Explanation

- When ordering, specify the part number.
- Check each code against the tables shown below.
- Fill in from the left, leaving any extra boxes empty on the right.



Part No.

Custom Specification code

Packaging and forming specification

Alphabetical symbols specify custom product.
Standard product has no symbols.

E2	Embossed tape and reel	Pin 1 fed last
E1	Embossed tape and reel	Pin 1 fed first
TR	Embossed tape and reel	Pin 1 fed last
TL	Embossed tape and reel	Pin 1 fed first

Ordering information

1. A packaging specification is not required for packaging other than taping.
(Ex.) BA4558F or BA4558F-DX
2. A packaging specification is required for tape packaging.
(Ex.) Example of E2-oriented embossed taping: BA4558F-E2 or BA4558F-DXE2

For example

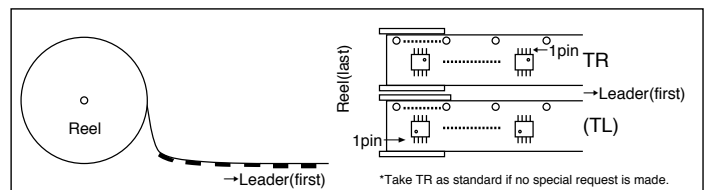
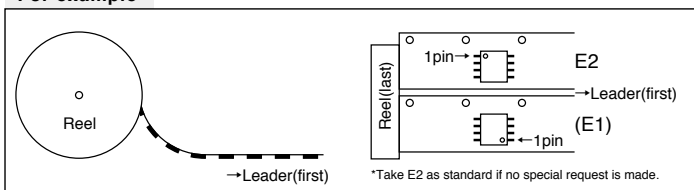

ROHM Website Updates

In order to meet the needs of current design practices we have expanded operability by enhancing 3 functions: **Search**, **View**, and **Buy**.

www.rohm.com

ROHM Semiconductor

Search

Search

Perform multiple search types

A variety of search types are now possible. Perform a cross-reference, inventory, product, or site search.

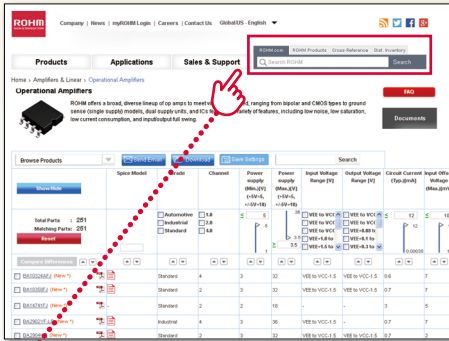

Product Search
Find applicable products via Parametric Search.

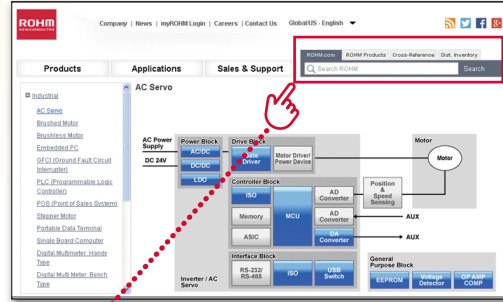

Application Search
Find applicable products from our Application Block Diagrams.

Access a variety of product information

Download

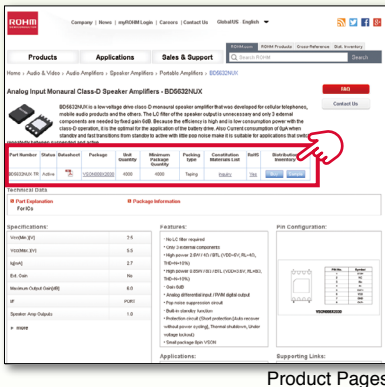

Product Pages

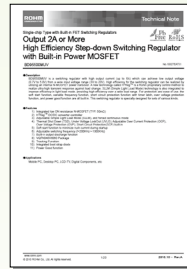

Datasheets

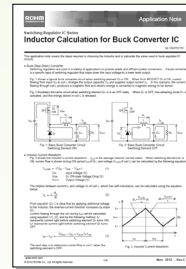

Application Notes

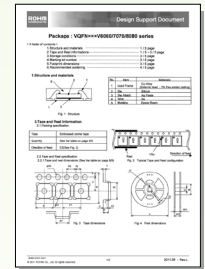

Package Information

Download product data including datasheets, application notes, and package information

View

Order products from our site

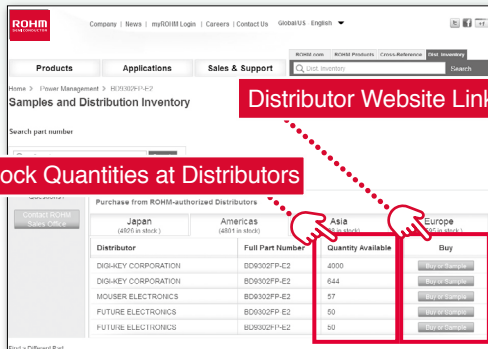

Stock Quantities at Distributors

Distributor Website Links

Check for product availability at a range of distributors, then order parts directly.

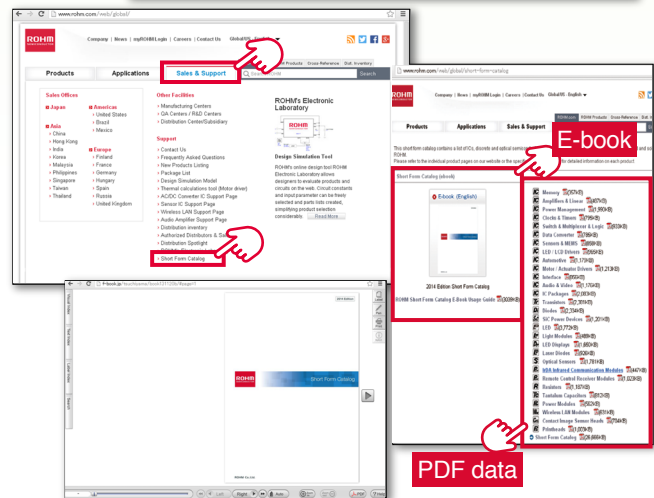

PDF data

E-book Image

Access the Short Form Catalog e-book and PDF directly from our home page to view the most up-to-date product information

Buy

ROHM Group Locations (Japan)

Main Sales Offices

Kyoto	Nagoya	Matsumoto	Sendai
Tokyo	Fukuoka	Mito	Takasaki
Yokohama		Nishi-Tokyo	Utsunomiya

Manufacturing Facilities

ROHM Hamamatsu Co., Ltd.	LAPIS Semiconductor Miyagi Co., Ltd.
ROHM Wako Co., Ltd.	LAPIS Semiconductor Miyazaki Co., Ltd.
ROHM Apollo Co., Ltd.	AGLED Co., Ltd.
ROHM Mechatech Co., Ltd.	

Design Centers

Kyoto Technology Center (Head Office)
Kyoto Technology Center (Kyoto Ekimae)
Yokohama Technology Center
LAPIS Semiconductor Co., Ltd.(Shin-Yokohama)
LAPIS Semiconductor Co., Ltd. Miyazaki Design Center
LAPIS Semiconductor Co., Ltd. Tsukuba Office

QA Centers

Kyoto QA Center
Yokohama QA Center

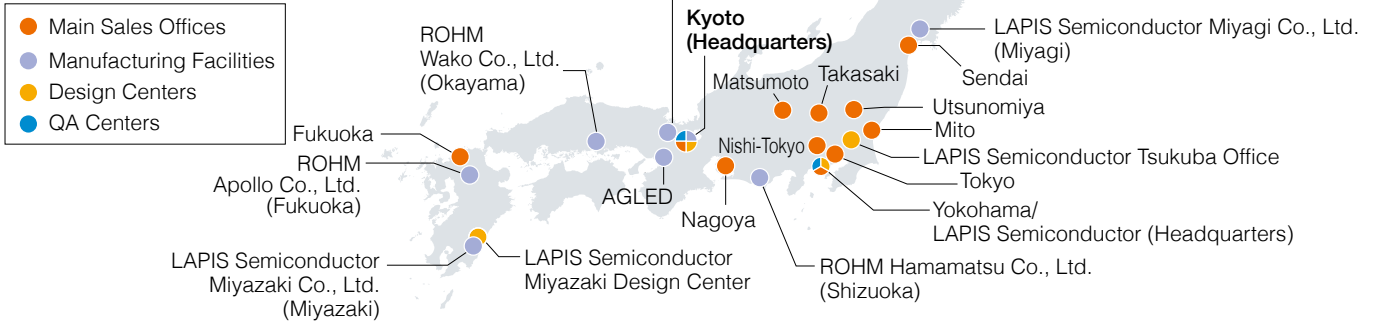

ROHM Co.,Ltd.

Company Name / ROHM Co., Ltd.

Headquarters / 21 Saiin Mizosaki-cho, Ukyo-ku,
Kyoto 615-8585 Japan
TEL: +81-75-311-2121 FAX: +81-75-315-0172

Date Established / September 17,1958

President / Satoshi Sawamura



ROHM Group Locations (Global)

Main Sales Offices

ASIA	ROHM Semiconductor Korea Corporation ROHM Semiconductor Trading (Dalian) Co., Ltd. ROHM Semiconductor (Shanghai) Co., Ltd. ROHM Semiconductor (Shenzhen) Co., Ltd. ROHM Semiconductor Hong Kong Co., Ltd. ROHM Semiconductor Taiwan Co., Ltd. ROHM Semiconductor Singapore Pte. Ltd. ROHM Semiconductor Philippines Corporation ROHM Semiconductor (Thailand) Co., Ltd. ROHM Semiconductor Malaysia Sdn. Bhd. ROHM Semiconductor India Pvt. Ltd.
AMERICA	ROHM Semiconductor U.S.A., LLC ROHM Semiconductor do Brasil Ltda.
EUROPE	ROHM Semiconductor GmbH

Manufacturing Facilities

ASIA	ROHM Korea Corporation ROHM Electronics Philippines, Inc. ROHM Integrated Systems (Thailand) Co., Ltd. ROHM Semiconductor(China) Co., Ltd. ROHM Electronics Dalian Co., Ltd. ROHM-Wako Electronics (Malaysia) Sdn. Bhd. ROHM Mechatech Philippines, Inc. ROHM Mechatech (Thailand) Co., Ltd. ROHM Mechatech (Tianjin) Co., Ltd.
------	---------------------------------------------------------------------------------------------------------------------------------------------------------------------------------------------------------------------------------------------------------------------------------------------------------------------------------------------------------

AMERICA	Kionix, Inc.
EUROPE	SiCrystal AG

Design Centers

ASIA	Korea Design Center Shanghai Design Center Shenzhen Design Center Taiwan Design Center India Design Center
AMERICA	America Design Center (Santa Clara) America Design Center (San Diego)
EUROPE	Europe Design Center

QA Centers

ASIA	Korea QA Center Shanghai QA Center Shenzhen QA Center Taiwan QA Center Singapore QA Center Thailand QA Center
AMERICA	USA QA Center
EUROPE	Europe QA Center

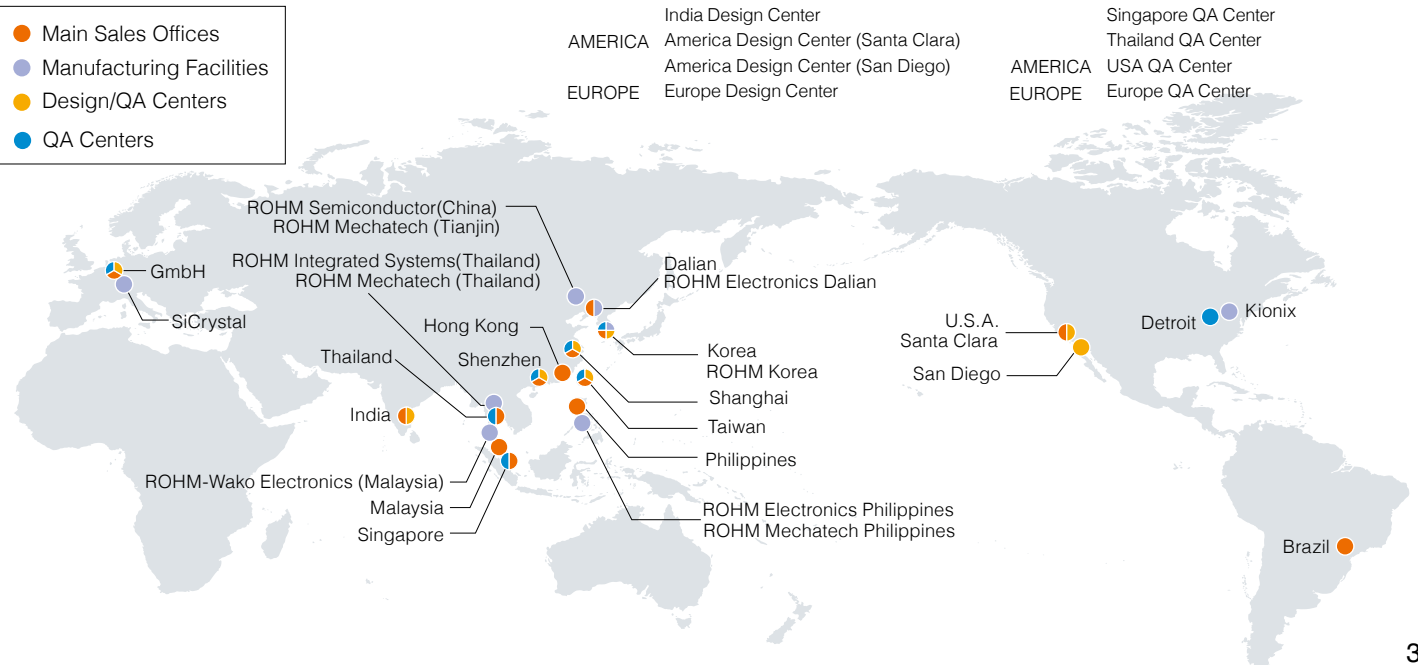

- All DRAM, FeRAM, NOR Flash, and P2ROM™ products that appear in this catalog have been developed and manufactured by LAPIS Semiconductor
- P2ROM™ is a trademark of LAPIS Semiconductor
- All products mentioned in this catalog (including LAPIS Semiconductor products) are sold by ROHM Co., Ltd.
- P2ROM™ is a trademark of LAPIS Semiconductor

- 1) The information contained in this document is provided as of August, 2014 .
- 2) The information contained herein is subject to change without notice. Before you use our Products, please contact our sales representative (as listed below) and verify the latest specifications.
- 3) Although ROHM is continuously working to improve product reliability and quality, semiconductors can break down and malfunction due to various factors. Therefore, in order to prevent personal injury or fire arising from failure, please take safety measures such as complying with the derating characteristics, implementing redundant and fire prevention designs, and utilizing backups and fail-safe procedures. ROHM shall have no responsibility for any damages arising out of the use of our Products beyond the rating specified by ROHM.
- 4) Examples of application circuits, circuit constants and any other information contained herein are provided only to illustrate the standard usage and operations of the Products. The peripheral conditions must be taken into account when designing circuits for mass production.
- 5) The technical information specified herein is intended only to show the typical functions of and examples of application circuits for the Products. ROHM does not grant you, explicitly or implicitly, any license to use or exercise intellectual property or other rights held by ROHM or any other parties. ROHM shall have no responsibility whatsoever for any dispute arising out of the use of such technical information.
- 6) The Products are intended for use in general electronic equipment (i.e. AV/OA devices, communication, consumer systems, gaming/entertainment sets) as well as the applications indicated in this document.
- 7) The Products specified in this document are not designed to be radiation tolerant.
- 8) For use of our Products in applications requiring a high degree of reliability (as exemplified below), please contact and consult with a ROHM representative: transportation equipment (i.e. cars, ships, trains), primary communication equipment, traffic lights, fire/crime prevention, safety equipment, medical systems, servers, solar cells, and power transmission systems.
- 9) Do not use our Products in applications requiring extremely high reliability, such as aerospace equipment, nuclear power control systems, and submarine repeaters.
- 10) ROHM shall have no responsibility for any damages or injury arising from non-compliance with the recommended usage conditions and specifications contained herein.
- 11) ROHM has used reasonable care to ensure the accuracy of the information contained in this document. However, ROHM does not warrant that such information is error-free and ROHM shall have no responsibility for any damages arising from any inaccuracy or misprint of such information.
- 12) Please use the Products in accordance with any applicable environmental laws and regulations, such as the RoHS Directive. For more details, including RoHS compatibility, please contact a ROHM sales office as listed below. ROHM shall have no responsibility for any damages or losses resulting non-compliance with any applicable laws or regulations.
- 13) When providing our Products and technologies contained in this document to other countries, you must abide by the procedures and provisions stipulated in all applicable export laws and regulations, including without limitation the US Export Administration Regulations and the Foreign Exchange and Foreign Trade Act.
- 14) This document, in part or in whole, may not be reprinted or reproduced without prior consent of ROHM.

ROHM Sales Offices

Contact us for further information about the products.

Santa Clara	+1-408-720-1900	Germany	+49-2154-921-0	Dalian	+86-411-8230-8549	India	+91-44-4352-0008
Atlanta	+1-770-754-5972	Stuttgart	+49-711-7272370	Shanghai	+86-21-6072-8612	Kyoto	+81-75-365-1218
Boston	+1-978-371-0382	France	+33 (0) 1 40 60 87 30	Shenzhen	+86-755-8307-3008	Yokohama	+81-45-476-2121
Chicago	+1-847-368-1006	United Kingdom	+44-1-908-272400	Hong Kong	+852-2740-6262		
Denver	+1-303-708-0908	Oulu	+358-400-726124	Taiwan	+886-2-2500-6956		
Detroit	+1-248-348-9920	Spain	+34-9375-24320	Singapore	+65-6436-5100		
San Diego	+1-858-625-3600	Hungary	+36-1-950-5859	Philippines	+63-2-807-6872		
Mexico	+52-33-3123-2001	Russia	+74 95 739 4174	Thailand	+66-2-254-4890		
Brazil	+55-11-3539-6320	Seoul	+82-2-8182-700	Malaysia	+60-3-7931-8155		

Catalog No.57P6773E-D.8.2014 ROHM © PDF

R1064A

ROHM Co., Ltd.

21 Saian Mizosaki-cho, Ukyo-ku,
Kyoto 615-8585 Japan

TEL : +81-75-311-2121 FAX : +81-75-315-0172

www.rohm.com

