

PIEZOELECTRIC CERAMIC SENSORS (PIEZOTITE®)

PIEZOELECTRIC CERAMICS SENSORS (PIEZOTITE®)



*Innovator
in Electronics*

**Murata
Manufacturing Co., Ltd.**

Preface

Recently, with the remarkable advance of electronics technology, various new products have come into existence. Until this time, the effect of electronics was seen most clearly in television, radio and other communications equipment, but as semiconductor technology, and computer technology advance, the range of electronics' effect on our lives has increased dramatically. In particular, sensor technology and the greater intelligent functions of today's microcomputers have served as a basis for the trend toward combining electronics and mechanics into what is called mechatronics.

It is not merely the equipment itself, however, that has made all this possible. Within the equipment are highly sophisticated components with unique functions which can translate electrical to mechanical energy and mechanical to electrical energy and which play a large role in today's equipment modernization and advance. These are piezoelectric components. This catalog briefly introduces the basics of piezoelectric ceramics, Murata's piezoelectric ceramic materials, piezoelectric transducers and other products.

Please insure the component is thoroughly evaluated in your application circuit.

In case that the component is not mentioned in our statement, please contact your Murata representative for details.

Table of Contents

Preface 1

1 Introduction 3

2 Characteristics of Piezoelectric Ceramics (PIEZOTITE®)

1. Resonant frequency and vibration mode 4

2. Piezoelectric material constant symbols 7

 1 Frequency constant N 7

 2 Piezoelectric constants d and g 7

 3 Electromechanical coupling coefficient K 7

 4 Mechanical Qm 7

 5 Young's modulus Y^E 8

 6 Poisson's ratioσ^E 8

 7 Densityρ 8

 8 Relative dielectric constant $\frac{\epsilon^T}{\epsilon_0}$ 8

 9 Curie temperature Tc 8

 10 Coercive field Ec 8

3 Murata's Piezoelectric Ceramics (PIEZOTITE®) Material

1. Characteristics of typical materials 9

2. Features of PIEZOTITE® materials 10

3. Temperature characteristics and aging 10

4 Murata's Piezoelectric Ceramic Resonators (PIEZOTITE®)

1. Shapes 11

2. Standard specification models 12

3. Notice 12

5 Piezoelectric Ceramic (PIEZOTITE®) Applications

Actuator 14–16

Molded Underwater Transducer 17

Ultrasonic Sensor 18–22

Shock Sensor 23–27

 SMD type PKGS-LA 23

 Thin and Small PKGS-LB 24

 Low-profile PKGS-MD 25

 Large Capacitance PKGS-LC 26

 Lead type PKS 27

Knocking Sensor Elements 28

Ultrasonic Bubble Sensor 29

Electric Potential Sensor 30–31

1 Introduction

2 Characteristics of Piezoelectric Ceramics (PIEZOTITE®)

3 Murata's Piezoelectric Ceramics (PIEZOTITE®) Material

4 Murata's Piezoelectric Ceramics Resonators (PIEZOTITE®)

5 Piezoelectric Ceramic (PIEZOTITE®) Applications

1 Introduction

1. What are Piezoelectric Ceramics?

Piezoelectric ceramics are known for what are called the piezoelectric and reverse piezoelectric effects. The piezoelectric effect causes a crystal to produce an electrical potential when it is subjected to mechanical vibration. In contrast, the reverse piezoelectric effect causes the crystal to produce vibration when it is placed in an electric field. Of piezoelectric materials, Rochelle salt and quartz have long been known as single-crystal piezoelectric substances. However, these substances have had a relatively limited application range chiefly because of the poor crystal stability of Rochelle salt and the limited degree of freedom in the characteristics of quartz. Later, barium titanate ($BaTiO_3$), a piezoelectric ceramic, was introduced for applications in ultrasonic transducers, mainly for fish finders. More recently, a lead titanate, lead zirconate system ($PbTiO_3 \cdot PbZrO_3$) appeared, which has electromechanical transformation efficiency and stability (including temperature characteristics) far superior to existing substances. It has dramatically broadened the application range of piezoelectric ceramics. When compared with other piezoelectric substances, both $BaTiO_3$ and $PbTiO_3 \cdot PbZrO_3$ have the following advantages :

■ADVANTAGES

- ①High electromechanical transformation efficiency.
- ②High machinability.
- ③A broad range of characteristics can be achieved with different material compositions (high degree of freedom in characteristics design).
- ④High stability.
- ⑤Suitable for mass production, and economical.

Murata, as a forerunner in the piezoelectric ceramic industry, offers an extensive range of products with piezoelectric applications.

2. Properties of Piezoelectric Ceramics

Piezoelectric ceramics are a type of multi-crystal dielectric with a high dielectric constant and are formed by two processes : first, high temperature firing. After firing, they have the characteristic crystal structure shown in Fig. 1 (a) but do not yet exhibit the piezoelectric property because the electrical dipoles within the crystals are oriented at random and the overall moment of the dipoles is canceled out. To make ceramics piezoelectric they must be polarized. A DC electric field of several kV/mm is applied to the piece of ceramic to align the internal electrical dipoles in a single orientation(see Fig. 1 (b)). Due to the strong dielectric property of the ceramic, the dipole moment remains unchanged after the electric field is removed, and the ceramic thus exhibits a strong piezoelectric property (see Fig. 1 (c)). When an AC signal is applied to a piezoelectric ceramic (piezoelectric transducer) in a frequency matching the specific elastic frequency of the ceramics (which depends on the shape of the material), the ceramic exhibits resonance. Since the ceramic has a very high electromechanical transforming efficiency at the point of resonance, many applications use this resonance point.

Also piezoelectric ceramics when molded in certain shapes have more than one point of resonance depending on vibration mode. In such a case, the vibration mode most suited for the application is selected.

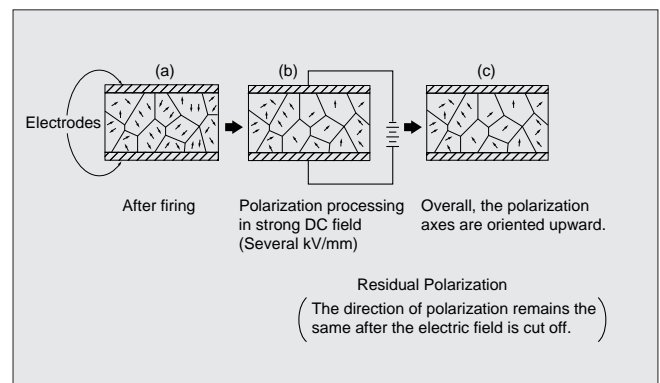

Fig. 1 Polarization Processing of Piezoelectric Ceramics

3. Application of Piezoelectric Ceramics

Product applications for piezoelectric ceramics include the following categories :
Murata has and is continuing to direct extensive research development efforts to the entire range of applications of piezoelectric ceramics listed in the right side. It is expected that the applications of piezoelectric ceramics will continue to extend into a broader range of industries as new piezoelectric materials are created.

This application manual concentrates on applications with mechanical power sources and sensors which are now finding broader applications.

■PIEZOELECTRIC APPLICATIONS

- ①Mechanical power sources (electrical-to-mechanical transducers) :
Piezoelectric actuators, piezoelectric fans, ultrasonic cleaners, etc.
- ②Sensors (mechanical-to-electrical transducers) :
Ultrasonic sensors, knocking sensors, shock sensors, acceleration sensors, etc.
- ③Electronic circuit components (transducers) :
Ceramic filters, ceramic resonators, surface acoustic wave filters, microforks, etc.

2 Characteristics of Piezoelectric Ceramics (PIEZOTITE®)

For using piezoelectric ceramics, it is important to first have an adequate knowledge of the properties of different piezoelectric materials before choosing a suitable type for a specific application.

The following sections describe the major characteristic which need to be evaluated to determine the properties of piezoelectric ceramic materials.

1. Resonant Frequency and Vibration Mode

If an AC voltage of varying frequency is applied to a piezoelectric ceramic (piezoelectric transducer) of a certain shape, it can be seen that there is a specific frequency at which the ceramic produces a very strong vibration. This frequency is called the resonant frequency, f_r , and depends on the ceramic's specific elastic vibration (resonance) frequency, which is a function of the shape of the material.

Piezoelectric ceramics have various vibration modes (resonant modes) which depend on their shape, orientation of polarization, and the direction of the electric field. Each of these vibration modes have unique resonant frequencies and piezoelectric

characteristics. Fig. 2 shows typical vibration modes in relation to the shapes of ceramic materials, the resonant frequency in each vibration mode, and the material constant symbols.

In Fig. 2, the piezoelectric material constant symbols have the following meanings :

- N : Frequency constant (described in Section 1).
- d : Piezoelectric strain constant (described in Section 2).
- g : Voltage output constant (described in Section 2).
- k : Electromechanical coupling coefficient (described in Section 3).
- Y^E : Young's modulus (described in Section 5).
- ϵ^T : Dielectric constant (described in Section 8).

Vibration Mode	Shape/Vibration Mode	Resonant Frequency (fr)	Material Constant Symbol					
			k	d	g	Y^E	ϵ^T	N
Radial Mode	 <p>P : Direction of polarization E : Direction of electric field</p> <p>Thin disk with radial vibration mode. Polarization is oriented along the thickness of the disk.</p>	$\frac{N_p}{d}$	k_p	d_{31}	g_{31}	Y_{11}^E	ϵ_{33}^T	N_p
Length Mode	 <p>Thin rectangular plate, with the direction of vibration orthogonal to the polarization axis and with a single point of resonance.</p>	$\frac{N_{31}}{l}$	k_{31}	d_{31}	g_{31}	Y_{11}^E	ϵ_{33}^T	N_{31}
Longitudinal Mode	 <p>Square and cylindrical columns. Vibration is oriented along the direction of polarization. Only a single point of resonance.</p>	$\frac{N_{33}}{l}$	k_{33}	d_{33}	g_{33}	Y_{33}^E	ϵ_{33}^T	N_{33}
Thickness Mode	 <p>Disk and rectangular plates which are thin compared to their surface areas. They have multiple points of resonance in longitudinal vibration mode.</p>	$\frac{N_t}{t}$	k_t	d_{33}	g_{33}	Y_{33}^E	ϵ_{33}^T	N_t
Shear Mode	 <p>Disk or rectangular plates, with the electric field orthogonal to the direction of polarization, causing a shear vibration along the surface.</p>	$\frac{N_{15}}{t}$	k_{15}	d_{15}	g_{15}	Y_{44}^E	ϵ_{11}^T	N_{15}

Fig. 2 Typical Vibration Modes, Resonant Frequencies, and Material Constant Symbols of Piezoelectric Ceramics

2

2 Characteristics of Piezoelectric Ceramics (PIEZOTITE®)

When a piezoelectric material is subjected to stress T , it produces polarization P which is a linear function of T : $P=d T$ (d : piezoelectric strain constant). This effect is called the normal piezoelectric effect. In contrast, when a piezoelectric substance has an electric field E applied across its electrodes, it produces distortion S which is a linear function of the electric field: $S=d E$. This effect is called the reverse piezoelectric effect. For an elastic material, the relationship of distortion S to the stress T is given by $S=s^E T$ (s^E : compliance); for a dielectric substance, the relationship of electrical displacement D with electric field strength E is given by $D=\epsilon E$. For a piezoelectric ceramic, these relationships are given by the following equations, both being associated with piezoelectric strain constants:

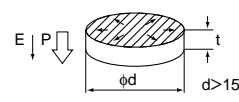
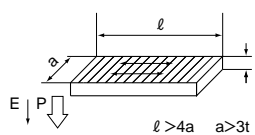
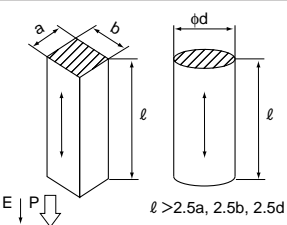
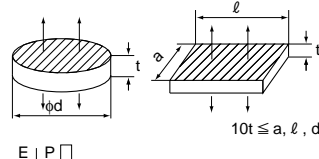
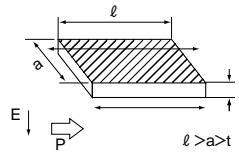
$$\left. \begin{aligned} S_i &= s_{ij}^E T_j + d_{mi} E_m \\ D_n &= d_{nj} T_j + \epsilon_{nm}^T E_m \end{aligned} \right\} \dots\dots\dots(1)$$

$(m, n = 1, 2, 3; i, j = 1, 2, \dots, 6)$

These equations are called the basic piezoelectric equations (type d), where the electric field E and electrical displacement D are represented in vector magnitudes; whereas stress T and distortion S are given in symmetrical tensile magnitudes. When the symmetry of the crystals is taken into account, Eq. (1) is simplified because some constants in the equations are nullified and some other constants become equal to a third set of constants.

With piezoelectric ceramics, when the polarization axis is placed along the z (3) axis and two arbitrary orthogonal axes (which are also orthogonal to the z axis and assumed to be the x (1) and y (2) axis), the crystal structure of the ceramic can be represented in the same way as that of 6mm crystals, in which case the only independent non-zero coefficients are the following ten constants:

$$s_{11}^E \left(\frac{1}{Y_{11}^E} \right), s_{12}^E \left(\frac{1}{Y_{12}^E} \right), s_{13}^E \left(\frac{1}{Y_{13}^E} \right), s_{33}^E \left(\frac{1}{Y_{33}^E} \right), s_{44}^E \left(\frac{1}{Y_{44}^E} \right),$$

$$d_{31}, d_{33}, d_{15}, \epsilon_{11}^T, \epsilon_{33}^T,$$

For example, the basic piezoelectric equations for longitudinal vibration of a rectangular ceramic strip is given by the following equations:

$$\left. \begin{aligned} S_1 &= s_{11}^E T_1 + d_{31} E_3 \\ D_3 &= d_{31} T_1 + \epsilon_{33}^T E_3 \end{aligned} \right\} \dots\dots\dots(2)$$

A piezoelectric ceramic transducer can be represented by an equivalent circuit which is derived from the basic piezoelectric equations representing its vibration mode. The circuit is called Maison's equivalent circuit. More generally, the equivalent circuit, as shown in Fig. 3, may be used to represent a piezoelectric ceramic. In this equivalent circuit, the serial resonant frequency f_s , and parallel resonant frequency f_p are given by the following equations:

$$\left. \begin{aligned} f_s &= \frac{1}{2 \pi \sqrt{L_1 C_1}} \\ f_p &= \frac{1}{2 \pi \sqrt{L_1 \cdot \frac{C_1 C_0}{C_1 + C_0}}} \end{aligned} \right\} \dots\dots\dots(3)$$

Constants f_s and f_p are necessary to determine the electro-mechanical coupling coefficient k .

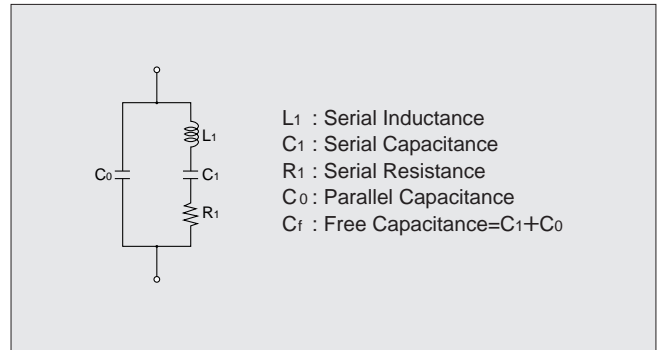

Fig. 3 Equivalent Circuit for Piezoelectric Ceramic Transducer

Strictly speaking, the resonant frequency can be defined in the following three ways:

- (1) Serial resonant frequency f_s of the equivalent serial circuit for a piezoelectric ceramic transducer.
- (2) Lower resonance frequency f_r , the lower of the two frequencies, where the cross-electrode admittance or impedance of the piezoelectric ceramic transducer is in the null phase.
- (3) Maximum admittance frequency f_m where the cross-electrode admittance of the piezoelectric ceramic transducer is maximized (impedance minimized).

However, the differences between the three frequencies, f_s , f_r , and f_m , is so small that it is negligible. In actual cases, therefore, when we measure frequency f_m , it can be called resonant frequency f_r . Also, the minimum admittance frequency f_n may be called antiresonant frequency f_a .

The resonant frequency f_r can be measured with either of the following two circuits:

Characteristics of Piezoelectric Ceramics (PIEZOTITE®) 2

■ Measuring Method Using Constant Voltage Circuit

The f_r measuring circuit using a constant voltage source is shown in Fig. 4.

The oscillator Osc and input resistors R_1 and R_2 are used to apply a constant voltage signal to the piezoelectric ceramic transducer. The current passing through the transducer is measured across output resistor R_2 .

If the transducer's impedance is much greater than R_2 , the voltmeter reading is proportional to the transducer's admittance. The frequency where the voltmeter reading is maximized is the resonant frequency f_r , and the frequency where the reading is minimized is the antiresonant frequency f_a .

Variable resistor R_v is used to determine the resonant resistance R_1 , which is needed to calculate the mechanical Q m.

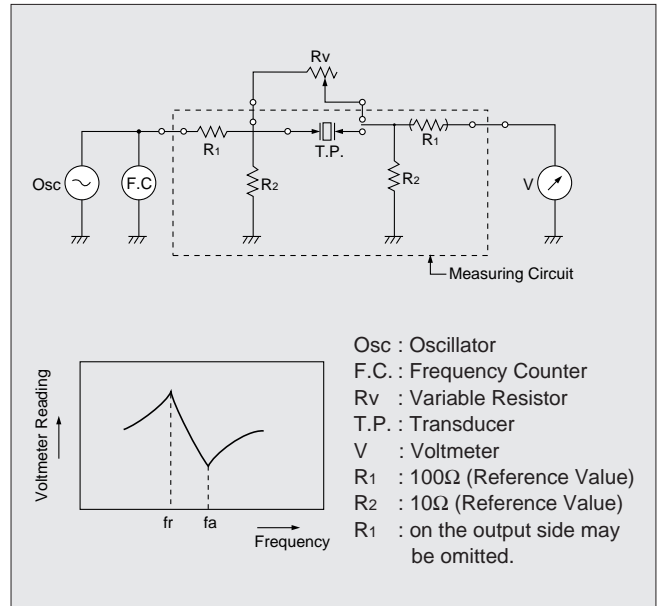

Fig. 4 Resonant Frequency Measuring Method Using Constant Voltage Circuit

■ Measuring Method Using Constant Current Circuit

The f_r measuring circuit using a constant current source is shown in Fig. 5. Resistor R_3 regulates the current passing through the piezoelectric ceramic transducer. If R_3 is much greater than the transducer's impedance, the voltmeter reading is proportional to the transducer's impedance. The frequency where the voltmeter reading is minimized is the resonant frequency f_r , and the frequency where the reading is maximized is the antiresonant frequency f_a .

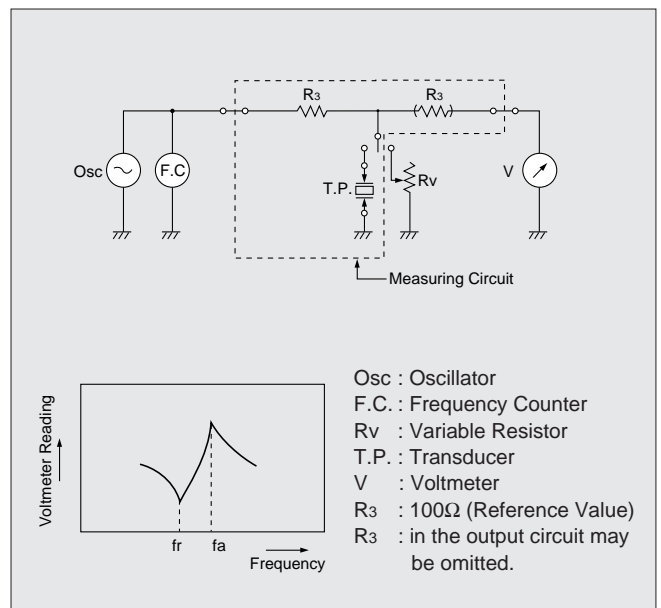

Fig. 5 Resonant Frequency Measuring Circuit Using Constant Current Circuit

2 Characteristics of Piezoelectric Ceramics (PIEZOTITE®)

2. Piezoelectric Material Constant Symbols

1 Frequency Constant N

The velocity of sound that propagates through a piezoelectric ceramic has a specific value in each vibration mode when the resonance of other vibration modes is not in the vicinity. For a piezoelectric ceramic with a certain shape, the relationship of wavelength λ of a vibration with propagation length ℓ at the resonant point is given by equation (4). Because the sound velocity is constant, we obtain the following equations (5) and (6) :

$$\frac{\lambda}{2} = \ell \dots\dots\dots(4)$$

$$v = fr \cdot \lambda \dots\dots\dots(5)$$

$$fr \cdot \ell = \frac{v}{2} = N \text{ (Hz} \cdot \text{m)} \dots\dots\dots(6)$$

where N is the frequency constant. The frequency constant depends on the vibration mode. The resonant frequency may also be determined by the equation, $fr = N / \ell$ as shown in Fig. 2.

2 Piezoelectric Constants d and g

① Piezoelectric Distortion Constant d

Piezoelectric distortion constant is the distortion resulting from the application of an electric field of uniform strength with no stress. It is given by equation (7) :

$$d = k \sqrt{\frac{\epsilon^T}{Y^E}} \text{ (m / V)} \dots\dots\dots(7)$$

where ϵ^T : Dielectric constant
 Y^E : Young's modulus (N / m²)
 k : Electromechanical coupling coefficient

$$d_{31} = k_{31} \sqrt{\frac{\epsilon_{33}^T}{Y_{11}^E}} \quad d_{33} = k_{33} \sqrt{\frac{\epsilon_{33}^T}{Y_{33}^E}} \quad d_{15} = k_{15} \sqrt{\frac{\epsilon_{11}^T}{Y_{44}^E}} \dots\dots\dots(8)$$

② Voltage Output Coefficient g

Voltage output coefficient refers to the field strength which results from a uniform stress applied under no electrical displacement. It is given by equation (9) :

$$g = \frac{d}{\epsilon^T} \text{ (V} \cdot \text{m/N)} \dots\dots\dots(9)$$

$$g_{31} = \frac{d_{31}}{\epsilon_{33}^T}, \quad g_{33} = \frac{d_{33}}{\epsilon_{33}^T}, \quad g_{15} = \frac{d_{15}}{\epsilon_{11}^T} \dots\dots(10)$$

Constants d and g depend on the vibration mode, and the constants in each vibration mode are given by the subscripted symbols shown in Fig. 2.

Displacements generated under an electric voltage or a voltage generated under force can be determined by constants d and g. For example, the displacement $\Delta \ell$ caused by voltage V applied across the electrodes in the lengthwise vibration mode is given by :

$$\Delta \ell = d_{31} \cdot \frac{\ell}{t} V \dots\dots\dots(11)$$

Conversely, the voltage V caused by force F applied along the direction of vibration is given by :

$$V = g_{31} \cdot \frac{1}{a} F \dots\dots\dots(12)$$

3 Electromechanical Coupling Coefficient k

The electromechanical coupling coefficient is a constant representing the piezoelectric efficiency of a piezoelectric ceramic. More specifically, it represents the efficiency of converting electrical energy (applied across the electrodes of a piezoelectric ceramic) into mechanical energy, and it is defined as the root mean square of the energy accumulated within the crystal in a mechanical form. This accumulated energy reflects the total electrical input.

$$\text{Electromechanical Coupling Coefficient} = \sqrt{\frac{\text{Accumulated Mechanical Energy}}{\text{Supplied Electrical Energy}}}$$

The electromechanical coupling coefficient depends on the vibration mode, as shown in Fig. 2. It is determined by the following equations using the resonant frequency fr , anti-resonant frequency fa , and their difference $\Delta f = fa - fr$.

① Radial Vibration of Disk Transducer

$$\frac{kp^2}{1 - kp^2} = \frac{(1 - \sigma^E) J_1 \{ \psi_1(1 + \Delta f / fr) \} - \psi_1(1 + \Delta f / fr) J_0 \{ \psi_1(1 + \Delta f / fr) \}}{(1 - \sigma^E) J_1 \{ \psi_1(1 + \Delta f / fr) \}} \dots\dots\dots(13)$$

where J_0, J_1 : Type 1 vessel functions of the 0th and 1st dimensions

σ^E : Poisson's ratio

ψ_1 : L₀ west dimension of positive root of

$$(1 - \sigma^E) J_1(\psi) = \psi J_0(\psi)$$

If kr is relatively small, equation (13) may be approximated as follows :

$$kp^2 \approx 2.529 \cdot \frac{\Delta f}{fr} \dots\dots\dots(14)$$

② Lengthwise Vibration of Rectangular Plate Transducer

$$\frac{k_{31}^2}{1 - k_{31}^2} = - \frac{\pi}{2} \cdot \frac{fa}{fr} \cot \left(\frac{\pi}{2} \cdot \frac{fa}{fr} \right) \dots\dots\dots(15)$$

③ Longitudinal Vibration of Cylinder Transducer

$$k_{33}^2 = \frac{\pi}{2} \cdot \frac{fr}{fa} \cot \left(\frac{\pi}{2} \cdot \frac{fr}{fa} \right) \dots\dots\dots(16)$$

④ Vibration Along Thickness of Disk Transducer

$$k_t^2 = \frac{\pi}{2} \cdot \frac{fr}{fa} \cot \left(\frac{\pi}{2} \cdot \frac{fr}{fa} \right) \dots\dots\dots(17)$$

⑤ Shear Vibration of Rectangular Plate Transducer

$$k_{15}^2 = \frac{\pi}{2} \cdot \frac{fr}{fa} \cot \left(\frac{\pi}{2} \cdot \frac{fr}{fa} \right) \dots\dots\dots(18)$$

4 Mechanical Qm

Mechanical Qm gives the "steepness" of resonance of a mechanical vibration at and around the resonant frequency. It is given by the following equation :

$$Qm = \frac{1}{2 \pi fr R_1 C_1} = \frac{1}{2 \pi fr R_1 Cf \left\{ 1 - \left(\frac{fr}{fa} \right)^2 \right\}} \dots\dots\dots(19)$$

where R_1 : Resonant resistance

Cf : Free capacitance across electrodes

Characteristics of Piezoelectric Ceramics (PIEZOTITE®) 2

5 Young's Modulus Y^E

When stress T is applied to an elastic body within the proportional elastic range, strain S is given by the following formula :

$$S = s^E T$$

s^E is an elasticity constant (compliance), and Young's modulus is given as the inverse of compliance. For lengthwise vibrations shown in Fig. 3, for example, the Young's modulus is given by the following equation :

$$Y_{11}^E = (2 \ell \text{ fr})^2 \cdot \rho = v^2 \cdot \rho \text{ (N / m}^2\text{)} \dots\dots\dots(20)$$

where ρ : Density (kg / m³)
 v : Sound velocity (m / s)

6 Poisson's Ratio σ^E

When a constant stress is applied to an elastic body within its proportional elastic range, Poisson's ratio is defined as follows :

$$\sigma^E = - \frac{\text{Distortion Rate Orthogonal to Stress}}{\text{Distortion Rate along Stress}}$$

7 Density ρ

Density can be determined from the volume and mass of any piezoelectric ceramic as follows :

$$\rho = \frac{m}{V} \text{ (kg / m}^3\text{)} \dots\dots\dots(21)$$

where m : Mass (kg)
 V : Volume (m³)

8 Relative Dielectric Constant $\frac{\epsilon^T}{\epsilon_0}$

Dielectric constant is an electrical displacement which results when a unity electric field is applied under no stress. It is given by the following formula :

$$D = \epsilon^T \cdot E$$

where E : Field strength
 D : Electrical displacement
 ϵ^T : Dielectric constant

Dielectric constant ϵ^T divided by the dielectric constant in a vacuum ϵ_0 ($=8.854 \times 10^{-12} \text{ F / m}$) is called the relative dielectric constant. For the lengthwise vibration mode shown in Fig. 2, if the free capacitance across the electrodes at 1 kHz is assumed to be C_f , the relative dielectric constant for an electric field in the same direction of polarization is given by the equation :

$$\frac{\epsilon_{33}^T}{\epsilon_0} = \frac{C_f \cdot t}{\ell \cdot a \cdot \epsilon_0} \dots\dots\dots(22)$$

For the vibration along thickness shown in Fig. 2, if the free capacitance across the electrodes at 1 kHz is assumed to be C_f , the relative dielectric constant for an electric field orthogonal to the direction of polarization is given by this equation :

$$\frac{\epsilon_{11}^T}{\epsilon_0} = \frac{C_f \cdot t}{\ell \cdot a \cdot \epsilon_0} \dots\dots\dots(23)$$

9 Curie Temperature T_c

Curie temperature refers to the critical temperature at which crystals in the piezoelectric ceramic lose their spontaneous polarization and hence their piezoelectric property. It is defined as the temperature at which the dielectric constant is maximized when the temperature is increased.

10 Coercive Field E_c

Ferroelectric materials have a domain structure, as shown in Fig. 1. The dipole moment in each domain is oriented in the same direction and causes spontaneous polarization. If a varying electric field E is applied to it, the overall variation of polarization draws a hysteresis loop, as shown in Fig. 6. Once the material has an electric field applied to it, it does not return to the original domain structure when the electric field is removed, resulting in remanent polarization P_r . To cancel P_r , a certain strength of reverse electric field must be applied. The field strength E_c required to cancel the remanent polarization is called a coercive field.

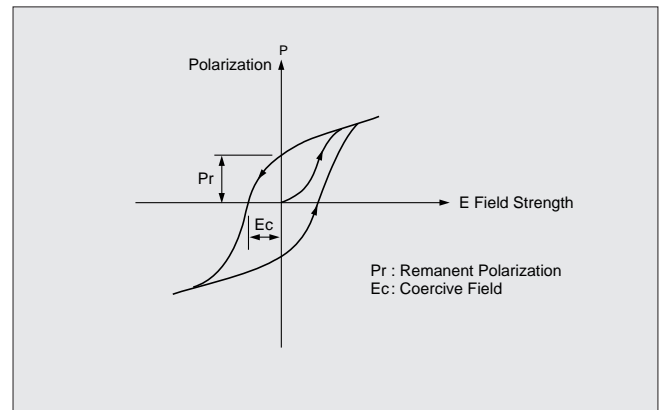

Fig. 6 Hysteresis Curve of a Ferroelectric Material

3 Murata's Piezoelectric Ceramics (PIEZOTITE®) Materials

1. Characteristics of Typical Materials

Table 1 shows the characteristics of typical Murata's piezoelectric ceramic materials.

Item	Symbol (Unit)	P-3	P-4	P-5E	P-6C	P-6E	P-6X	P-7	P-7B
Relative Dielectric Constant	$\epsilon_{33}^T/\epsilon_0$	1070	200	1510	800	1380	410	2100	4720
	$\epsilon_{33}^T/\epsilon_0$	—	247	1490	760	1260	780	1930	3200
Loss Coefficient	$\tan \delta$ (%)	0.5	0.6	0.4	1.0	1.4	0.5	1.4	2.2
Electro-mechanical Coupling Factor	k_p Radial (%)	22	10	56	39	46	47	65	65
	k_{31} Length (%)	15	6	32	21	26	27	38	36
	k_{33} Longitudinal (%)	44	48	62	50	60	61	71	68
	k_t Thickness (%)	36	48	45	43	44	48	51	47
	k_{15} Shear (%)	—	35	60	47	53	64	66	57
Piezoelectric Constant	d_{31} (10^{-12}m/V)	-44	-7	-131	-3	-94	-50	-207	-303
	d_{33} (10^{-12}m/V)	133	58	271	135	235	130	410	603
	d_{15} (10^{-12}m/V)	—	71	400	196	309	296	550	592
	g_{31} ($10^{-3}\text{V}\cdot\text{m/N}$)	-5	-4	-10	-8	-8	-14	-11	-7
	g_{33} ($10^{-3}\text{V}\cdot\text{m/N}$)	14	33	20	19	19	36	22	14
	g_{15} ($10^{-3}\text{V}\cdot\text{m/N}$)	—	32	30	29	28	43	32	21
Frequency Constant	N_p Radial (%)	3140	2710	2250	2520	2410	2440	2050	1960
	N_{31} Length (%)	2270	2060	1610	1850	1730	1800	1430	1370
	N_{33} Longitudinal (%)	2210	2030	1550	1820	1670	1650	1400	1350
	N_t Thickness (%)	2590	2150	2060	2130	2110	2100	2000	1970
	N_{15} Shear (%)	—	1340	1010	1150	1080	1050	930	930
Mechanical Q	Q_m	720	2000	970	680	410	830	80	70
Elastic constant	S_{11}^E ($10^{-12}\text{m}^2/\text{N}$)	8.7	7.6	12.4	9.4	11.1	9.8	15.8	16.7
	S_{12}^E ($10^{-12}\text{m}^2/\text{N}$)	-2.6	-1.6	-4.1	-3.0	-3.6	-2.8	-5.7	-5.9
	S_{13}^E ($10^{-12}\text{m}^2/\text{N}$)	-2.9	-1.7	-5.2	-3.0	-4.3	-4.2	-7.0	-7.5
	S_{33}^E ($10^{-12}\text{m}^2/\text{N}$)	9.6	8.2	14.3	10.3	12.7	12.6	18.1	18.8
	S_{44}^E ($10^{-12}\text{m}^2/\text{N}$)	—	18.5	34.0	25.6	30.0	31.0	40.6	38.8
	S_{66}^E ($10^{-12}\text{m}^2/\text{N}$)	22.7	18.5	33.0	24.8	29.3	25.3	43.0	45.4
	Y_{11}^E (10^{10}N/m^2)	11.5	13.1	8.1	10.7	9.0	10.2	6.3	6.7
Poisson's Ratio	σ^E	0.30	0.21	0.33	0.32	0.33	0.28	0.36	0.36
Density	ρ (10^3kg/m^3)	5.6	7.7	7.8	7.7	7.6	7.9	7.8	8.0
Temperature Coefficient	TK (fr) (ppm/°C)	—	—	115	10	35	-249	59	336
	TK (Cf) (ppm/°C)	—	2200	3500	2500	3000	2000	4500	13500
Curie Temperature	T_c (°C)	120	430	280	320	270	320	300	180
Linear Expansion Ratio	α ($10^{-6}/\text{°C}$)	5	0.2	4	2	3	2	2	2
Bending Strength	τ (kg/cm^2)	1160	1560	1160	1280	1190	1290	1010	870
Compressive Strength	K_{1c} ($10^6\text{N/m}^{1.5}$)	—	—	1.1	1.3	1.2	1.3	0.8	0.9
Application		Fish finders sonars	Knock sensors for high frequency	Ultrasonic cleaners Actuators for high power	Knock sensors	Sensors	Sensors	Ultrasonic sensors Pickups Actuators Acoustic	Actuators Acoustics

Note : This table shows typical values measured on standard test piece. Q_m , TK (fr) and TK (Cf) are measured for radial vibration mode.

Table 1 Characteristics of Murata's Typical Piezoelectric Ceramics (PIEZOTITE®)

Murata's Piezoelectric Ceramics (PIEZOTITE®) Materials 3

2. Features of PIEZOTITE® Materials

Table 2 shows the features of PIEZOTITE® materials. Murata's piezoelectric ceramics include three types : barium titanate (BaTiO₃) , lead titanate (PbTiO₃) , and lead zirconate

titanate (PbTiO₃ · PbZrO₃) Materials using lead zirconate titanate are available with three different properties suitable for different applications.

Type	Type Number	Features
Barium Titanate	P-3	The major constituent of P-3 is barium titanate, with titanate additives to improve the characteristics at room temperature. While it has a lower electromechanical coupling coefficient and Curie temperature compared to Lead Zirconate Titanate, it is practical in underwater applications and has the advantage of economy. With these features, P-3 is best suited for use in fish finders or sonar.
	P-4	Featuring a high Curie temperature, P-4 easily endures high temperature environments of up to 300 °C and is used for sensors in harsh environments. It has an anisotropic electromechanical coupling coefficient.
Lead Zirconate Titanate	P-5E	Featuring a large electromechanical-coupling coefficient, mechanical Qm and minimal aging, P-5 is widely used for ultrasonic cleaners, high-power ultrasonic transducers, and other acoustic power applications.
	P-6C	Features superior temperature characteristics of resonant frequency and minimal aging. P-6 is often used in ceramic filters, ceramic resonators requiring high stability.
	P-7	Features large electromechanical coupling coefficient, constant d and small mechanical Qm. P-7 has applicaitons in piezoelectric buzzers, ultrasonic sensors, and other applications requiring non-resonance or broad bandwidth.

Table 2 Features of Piezoelectric Ceramics

3. Temperature Characteristics and Aging

Fig. 7 shows examples of temperature characteristics of various materials.

Fig. 8 shows examples of aging characteristics of various materials. These examples show small aging characteristics.

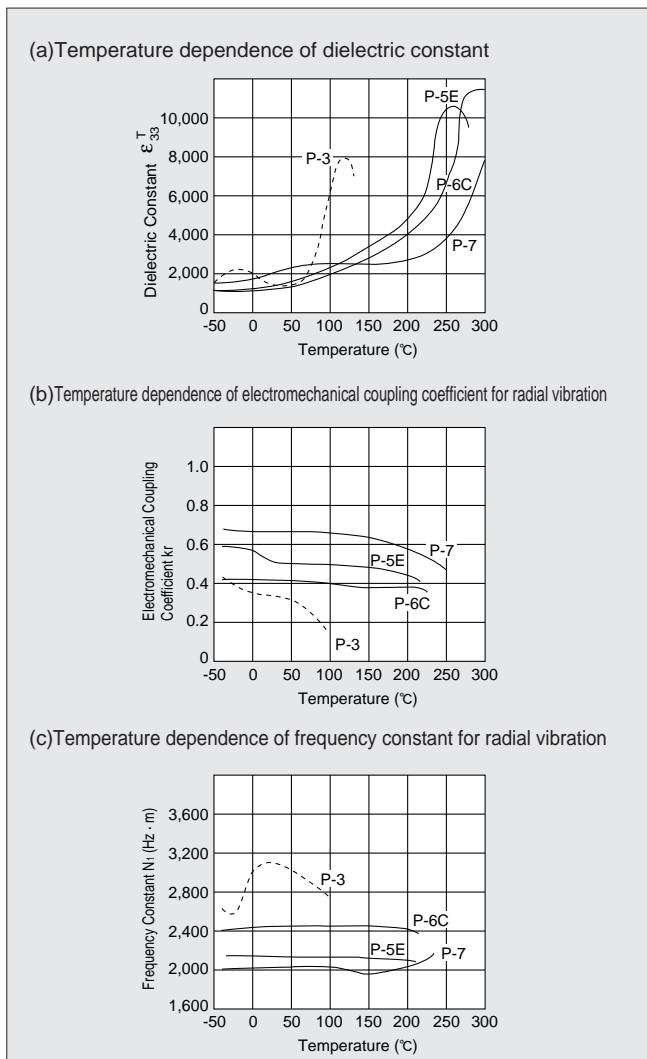

Fig. 7 Temperature Characteristics of Various Materials

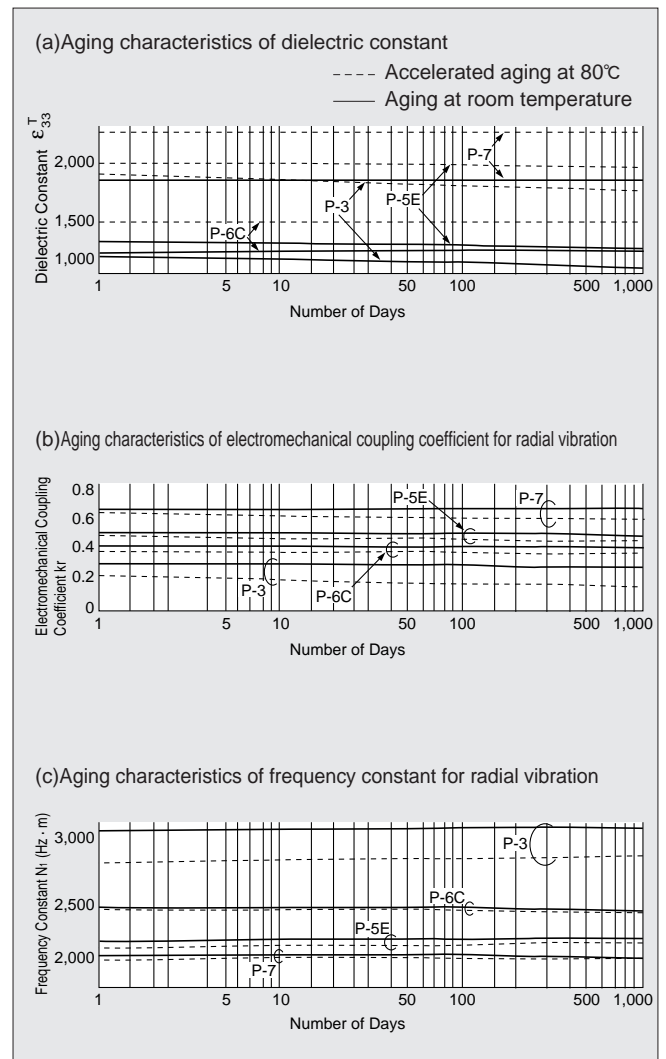

Fig. 8 Aging Characteristics of Various Materials

4 Murata's Piezoelectric Ceramics Resonators (PIEZOTITE®)

1. Shapes

PIEZOTITE® by Murata is available in various forms as shown in Fig.9. Other types can also be manufactured upon requests. Please contact us for more information.

Shape	Diagram	Vibration Mode	Part Numbering (Ex.)
Disk		Radial Thickness	<p>3 D - 60 - 75</p> <p>① ② ③ ④</p> <p>① Indicates material P-3. ② Indicates disk cylinder. ③ Diameter d (mm) ④ Resonant frequency (thickness mode) (kHz)</p>
Rectangular Plate		Thickness Length	<p>7 R - 4 - 1 - 6700</p> <p>① ② ③ ④ ⑤</p> <p>① Indicates material P-7. ② Indicates rectangular plate or pillar. ③ Length a (mm) ④ Width b (mm) ⑤ Resonant frequency (thickness mode) (kHz)</p>
Ring		Thickness	<p>3 C - 50 - 6 - 200</p> <p>① ② ③ ④ ⑤</p> <p>① Indicates material P-3. ② Indicates ring. ③ Outer diameter d1 (mm) ④ Inner diameter d2 (mm) ⑤ Resonant frequency (thickness mode) (kHz)</p>
Hollow Cylinder		Respiratory Thickness	<p>3 T - 38 - 10 - 40</p> <p>① ② ③ ④ ⑤</p> <p>① Indicates material P-3. ② Indicates hollow cylinder. ③ Diameter d (mm) ④ Height h (mm) ⑤ Resonant frequency (thickness or respiratory mode) (kHz)</p>

Fig. 9 Shapes of Murata's Piezoelectric Ceramics PIEZOTITE®

■Special Specification

The following special processing can be performed to meet specific customer's request.

a. Lead Bonding

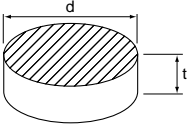
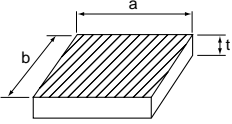
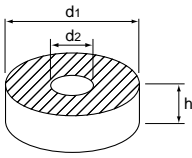
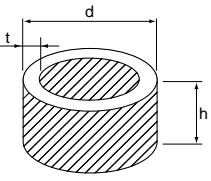
If the lead wire is to be soldered, write "A" at the end of the part number. (Ex.)7R-4-1-6700A

b. Electrode Mounting

If the electrode is to be partially turned back up to the opposite side, write "B" at the end of the part number. (Ex.)3D-60-75B

c. Coating

For epoxy resin coating which protects the element, write "K" at the end of the part number. (Ex.)3T-38-10-40K

d. Others

In some cases of special machining, symbol shall be added to denote machining procedures. (Ex.)3D-60-75BA, 3D-60-75KA, 3D-60-75BKA

Murata's Piezoelectric Ceramics Resonators (PIEZOTITE®) 4

2. Standard Specification Models

Table 3 shows standard specifications of PIEZOTITE® models. Specifications other than the standard specifications are also available. Please consult us.

	Part Number	Dimensions (mm)	Resonant Frequency (kHz)	Coupling Coefficient (%)	Capacitance (pF)	Applications
Disks	3D-60-75	60dX 34t	75 (Thickness mode)	23 (kp)	870	Fish finder
	3D-100-200KA	100 X12.8	200 (Thickness mode)	23 (kp)	6200	Fish finder
	5ED-50-570	50 X 3.5	46 (Radial mode)	48 (kp)	6400	US cleaner
	7D-10-6700	10 X 0.3	200 (Radial mode)	45 (kp)	4600	Pickup
	7D-25-400	25 X 5	80 (Radial mode)	55 (kp)	1700	Pickup
	7D-25-1600	25.5 X1.27	80 (Radial mode)	57 (kp)	5000	Knock sensor
Rectangular Plates	5ER-2R5-2-13000	2.5aX 2bX0.15t	890 (Length mode)	40 (k ₃₁)	390	Pickup
	6ER-2R4-2-13000	2.4 X 2 X0.15	660 (Length mode)	20 (k ₃₁)	400	Pickup
	7R-4-1-6000	4 X 1 X0.33	350 (Length mode)	20 (k ₃₁)	210	Pickup
	7R-4-1-6700	4 X 1 X0.3	350 (Length mode)	20 (k ₃₁)	230	Pickup
	7R-6-1-2500	6 X 1 X0.8	235 (Length mode)	20 (k ₃₁)	135	Pickup
	7R-8-2-4000	8 X 2 X0.5	180 (Length mode)	25 (k ₃₁)	510	Pickup
	7R-34-23-6700	32.8 X22.3 X0.3	42 (Length mode)	20 (k ₃₁)	42000	Pickup
Rings	3C-28-9-200-1	28 dX 9dX 10h	218 (Thickness mode)	34 (kt)	550	Fish finder
	3C-50-6-200-1	50 X 6 X 13	200 (Thickness mode)	28 (kt)	1500	Fish finder
	4C-19R5-15R3-5300	19.5 X15.3 X0.4	5300 (Thickness mode)	56 (kt)	470	Knock sensor
	6CC-10-3R9-1000	10 X 3.9 X 2	180 (Radial mode)	20 (kp)	230	Knock sensor
	6CC-10-4R9-1000-1	10 X 4.9 X 2	220 (Radial mode)	23 (kp)	220	Knock sensor
	7C-8-3-1700	8 X 3 X1.2	180 (Radial mode)	40 (kp)	500	Actuator
	7C-10-4-1700	10 X 4 X1.2	144 (Radial mode)	40 (kp)	950	Pickup
Cylinders	3T-38-10-40	38dX 10hX 2t	40 (Respiratory mode)	16 (k ₃₁)	5900	Ultrasonic sensor
	7T-38-30-25	38 X 30 X2.6	25 (Respiratory mode)	23 (k ₃₁)	20000	Ultrasonic sensor
	7T-14-10-75	14 X 10 X 2	75 (Respiratory mode)	25 (k ₃₁)	3200	Ultrasonic sensor

Table 3 Standard Specifications of PIEZOTITE® Models

3. Notice

Do not touch the component with bare hand because electrode may be damaged.

5 Piezoelectric Ceramic (PIEZOTITE®) Applications

Piezoelectric ceramics transform electrical energy into mechanical energy and vice versa. Fig. 10 shows our PIEZOTITE® in applications which utilize this basic function of piezoelectric ceramics as an electrical-mechanical energy transducer. In addition to the current line of products, Fig. 10 also lists some prototypes still under development (*). Please consult us concerning custom specifications and production of these new

products. The application products are shown in , which are explained details in the following pages. For other products not shown in Fig. 10, please contact us. Items marked with an asterisk (*) in Fig. 10 are available with individual catalogs and application manuals. For more details, refer to those related materials.

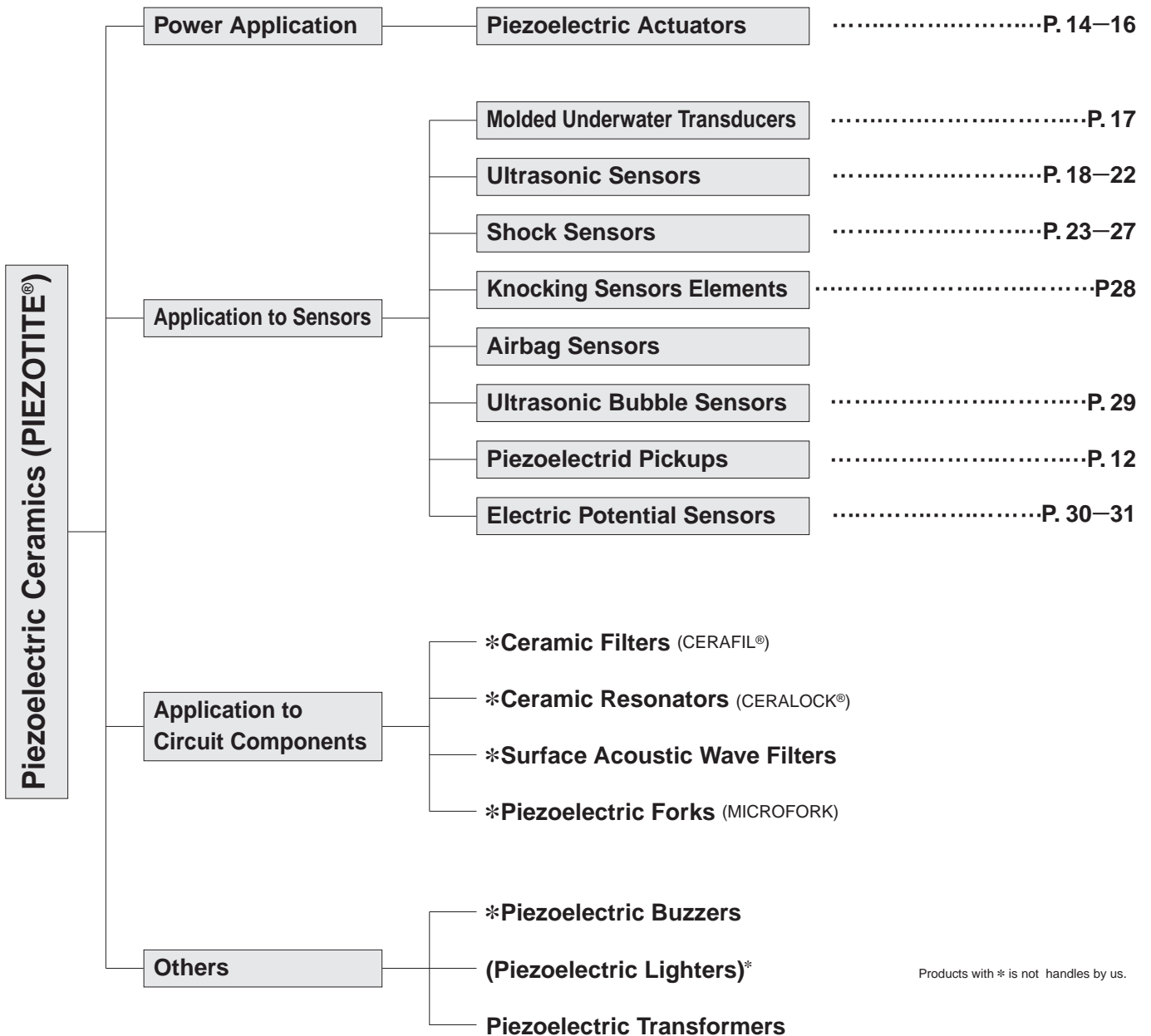

Products with * is not handles by us.

Fig. 10 Piezoelectric Ceramics (PIEZOTITE®) Applications

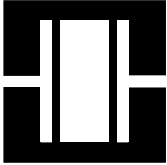

PIEZOTITE®



Piezoelectric Actuator

Exact displacement of 0.01µm to several hundreds µm can be obtained by controlling the applied voltage. Piezoelectric actuators are used in the tracking adjustment of VCR heads, focus adjustment of VCR cameras, shutter drives of cameras, ink-jet printers and braille cells. To meet these various needs, piezoelectric actuators can be manufactured according to user's request. Please contact us for more details.

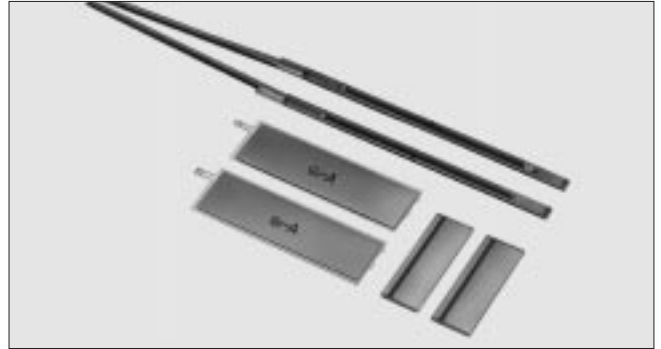

■SPECIFICATIONS (Typical)

Item	Piezoelectric Strain Constant		Corrective Coefficient	Elastic Constant (corrected value)		Coercive Field	Relative Dielectric Constant	Hysteresis
	$d_{31}(10^{-12}m / V)$	$d_{33}(10^{-12}m / V)$		$Y_{11}E(10^{10}N / m^2)$	$Y_{33}E(10^{10}N / m^2)$			
P-5E	131	271	0.06	7.5	8.0	1500	1510	3
P-7	207	410	1.08	5.5	5.5	800	2100	10
P-7B	303	603	3.89	5.0	5.5	500	4720	20

* In addition to the above materials, numerous materials are available for various application.
 * Hysteresis vary according to the applied voltage or shape (See Fig.2)

■NOTICE

Please note that the component may be damaged if excess stress input voltage is applied. Please refer to the individual specification for the max. input voltage.

5

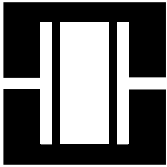

PIEZOTITE®



Piezoelectric Actuator

1. Bimorph Type Actuator

FEATURES

1. Large displacement achieved with low voltage.
2. Compact, low-cost design.
3. High response speed.

CHARACTERISTICS (Construction in Fig.1)

1. Hysteresis

CONSTRUCTION

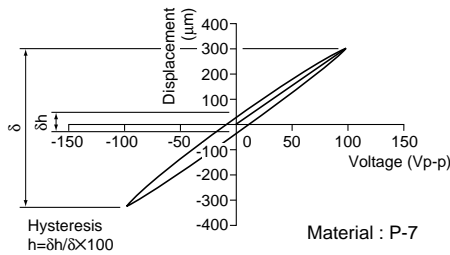
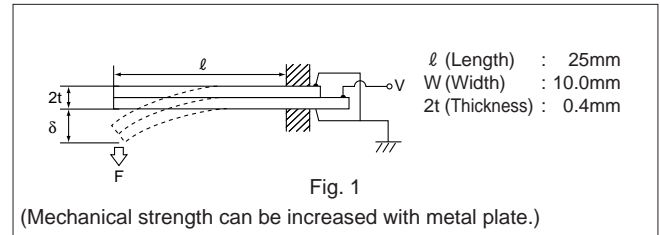

Fig. 2

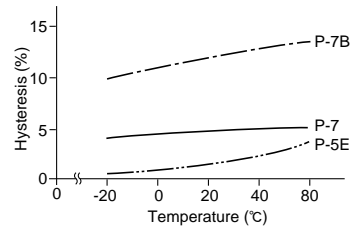

Fig. 3

2. Displacement

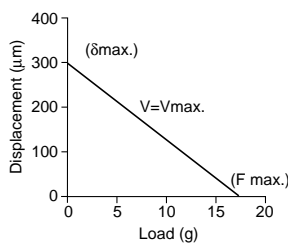

Fig. 4

Material : P-7
 Voltage : 100Vp-p
 Displacement : $\delta = 3 \cdot D_{31} \cdot V \cdot \left(\frac{l}{2t}\right)^2$
 Generated force : $F = \frac{3}{4} \cdot D_{31} \cdot V \cdot \left(\frac{2tW}{l}\right) \cdot Y_{11}$
 ($D_{31} = d_{31} + M \cdot V / 2t$)
 (F : Load at 0 displacement)
 Maximum allowable voltage : $V_{max} = 0.7 \cdot E_c \cdot t$

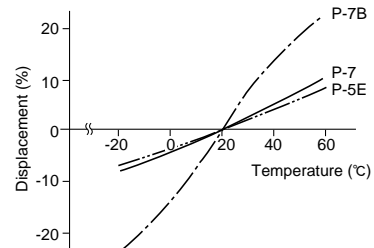

Fig. 5

3. Material, shape vs1. Displacement

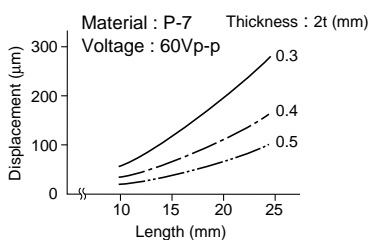

Fig. 6

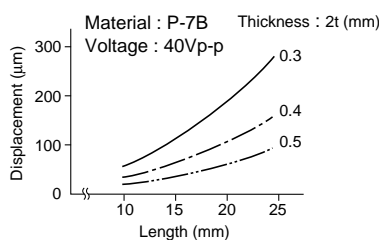

Fig. 7

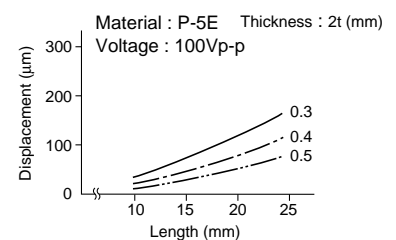
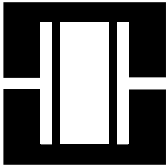

Fig. 8

5



PIEZOTITE®



Piezoelectric Actuator

2. Multilayer Type Actuator

■FEATURES

- 1. Superior load-sustaining performance.
- 2. Precise micro-displacement.
- 3. High displacement response speed.

■CHARACTERISTICS (Construction in Fig.9)

1. Hysteresis

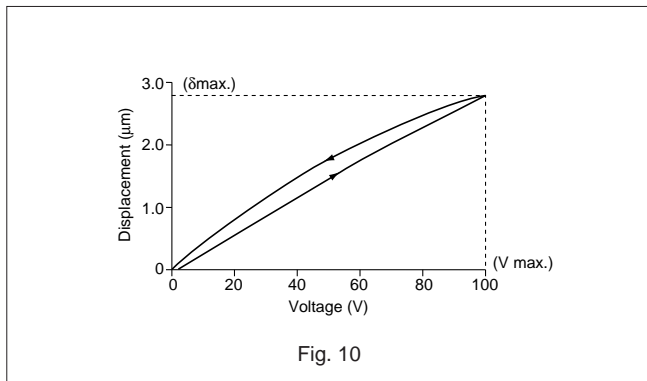

■CONSTRUCTION

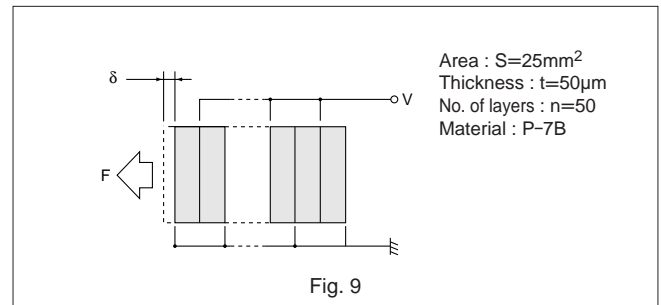

2. Displacement

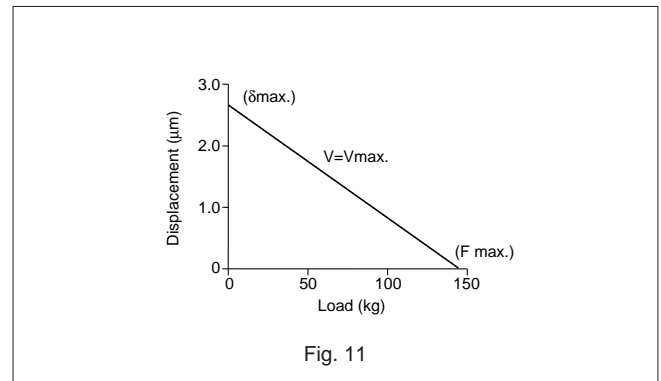

5

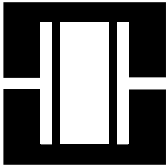

PIEZOTITE®



Molded Underwater Transducer

The molded underwater transducer is often used in fish finders and depth sounders. It emits an ultrasonic wave into the water so that the appropriate receiving device can detect the reflected wave in order to prove for fish or determine depth. Designed specifically for underwater use, this vibrator features not only high sensitivity but superior waterproof performance. The rugged design easily gives excellent performance even under high water pressure and waves. Many models are available for use at different frequencies, input powers, and in a variety of mounts.

FEATURES

- 1.Unique mold technique using rubber, urethane, epoxy resin and other materials assures high sensitivity and dependability.
- 2.Many models are available for different driving frequencies, allowable input powers, and shapes.



DIMENSIONS

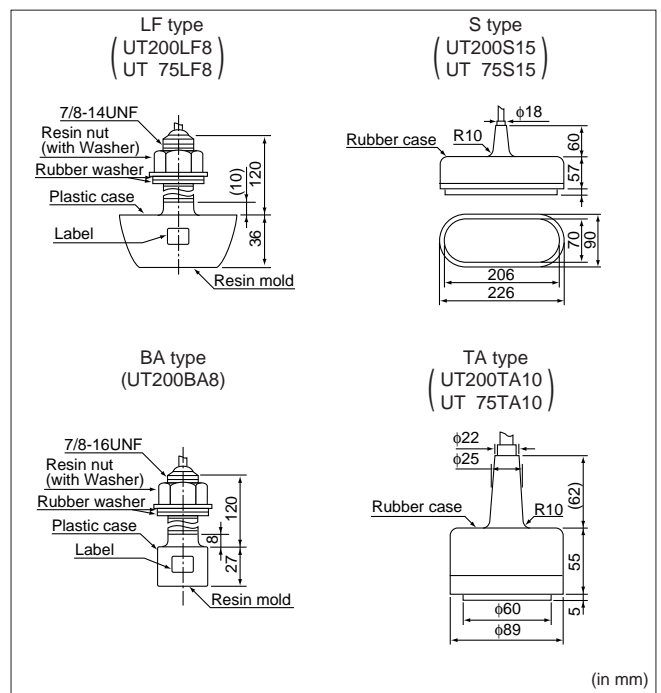

PART NUMBERING

(*Please specify part number when ordering)



- ① Molded underwater transducer
- ② Nominal resonant frequency
- ③ Style
- ④ Wire length (m)

NOTICE

- 1.Pay close attention to directional characteristics when mounting.
- 2.Please avoid applying DC-bias by connecting DC blocking capacitor or some other way because, otherwise, the component may be damaged.
- 3.Do not use in the air.

STANDARD SPECIFICATIONS

Resonant Frequency (kHz)	Part Number	Capacitance (pF)	Resonant Impedance (Ω)	Directivity (deg)	Allowable Input Power (W)
75	UT75LF8	4000	230 - 430	40	200
	UT75TA10	1900	600 - 1400	27	500
	UT75S15	4290	250 - 500	—	1000
200	UT200BA8	1700	310 - 590	22	50
	UT200LF8	2700	230 - 430	12	200
	UT200TA10	2800	200 - 400	12	500
	UT200S15	9000	30 - 100	—	1000

Allowable input power : Denotes the instantaneous input power applied to Molded underwater transducer driven underwater. The driving duty ratio is assumed to be 1 / 200(the values in the table above are guidelines).

Directivity : The degree when sound pressure level is 6 dB down compared with the value at 0 degree.

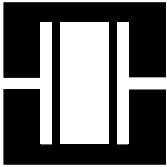

PIEZOTITE®



Ultrasonic Sensor MA Series

Higher Sensitivity and Sound Pressure Excellent Characteristics against Temperature and Humidity

This sensor radiates ultrasonic waves and detects echo, having many applications in measuring and detecting objects.

Based on its piezoelectric ceramics technology, Murata has various types of ultrasonic sensors of compact and higher performances.

FEATURES

1. Compact and light weight
2. High sensitivity and sound pressure
3. Less power consumption
4. High reliability

PART NUMBERING

(*Please specify the part number when ordering)

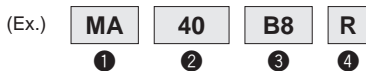

- ① Ultrasonic Sensor
- ② Nominal Frequency
- ③ Design Number
- ④ R : Receiver, S: Sounder

CLASSIFICATION

1. Open Structure Type
Using combined vibration mode of bimorph transducer and radial corn, this type realizes high sensitivity and high sound pressure level.
Applications : Automatic doors , Burglar alarms , Remote control, Range finders.
2. Water Proof Type
This type has excellent resistance to harsh environmental conditions and can be used outdoors because of its tightly sealing structure.
Applications : Back sonar of automobiles, Parking meters, Water level meters.
3. High Frequency Type
Using longitudinal vibration and matching with the air by acoustic matching layer, this type realized high sensitivity.
Because of short wavelength, this type has sharp directivity and can be used high precise measurement.
Applications : Approach switch for FA, distance meter, water or liquid level meters.

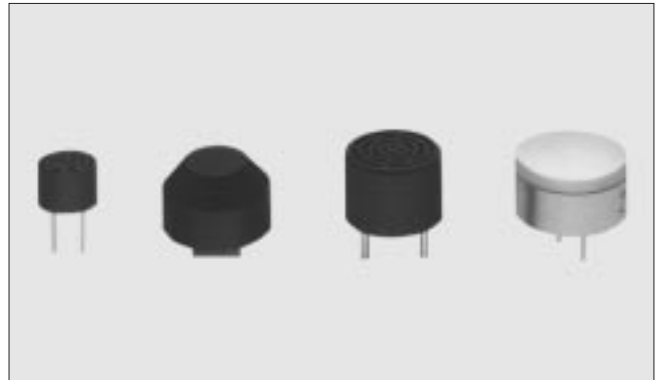

TEST CIRCUIT

Receiver

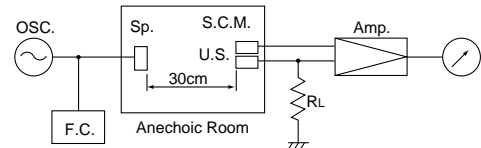

- RL : 3.9kΩ
- U.S. : Ultrasonic Sensor
- S.C.M. : Standard Capacitor Microphone (Brüel & Kjær4135)
- Amp. : Amplifier (Brüel & Kjær2610)
- OSC. : Oscillator
- Sp. : Tweeter
- F.C. : Frequency Counter
- 0dB=1V / μbar

Transmitter

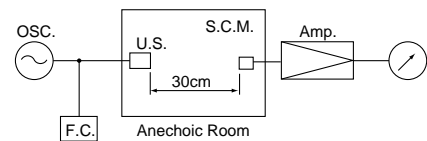

- U.S. : Ultrasonic Sensor
- S.C.M. : Standard Capacitor Microphone (Brüel & Kjær4135)
- Amp. : Amplifier (Brüel & Kjær2610)
- Input Voltage : 10Vrms
- F.C. : Frequency Counter
- 0dB=2X10⁻⁴μbar

Combined Use Type

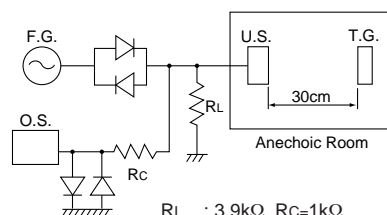

- RL : 3.9kΩ Rc=1kΩ
- U.S. : Ultrasonic Sensor
- T.G. : Target
- F.G. : Function Generator
- O.S. : Oscilloscope

5

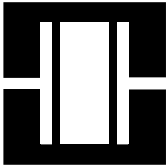

PIEZOTITE®



Ultrasonic Sensor MA Series

■ DIMENSIONS

● RECEIVER AND TRANSMITTER (DUAL USE) TYPE

(in mm)

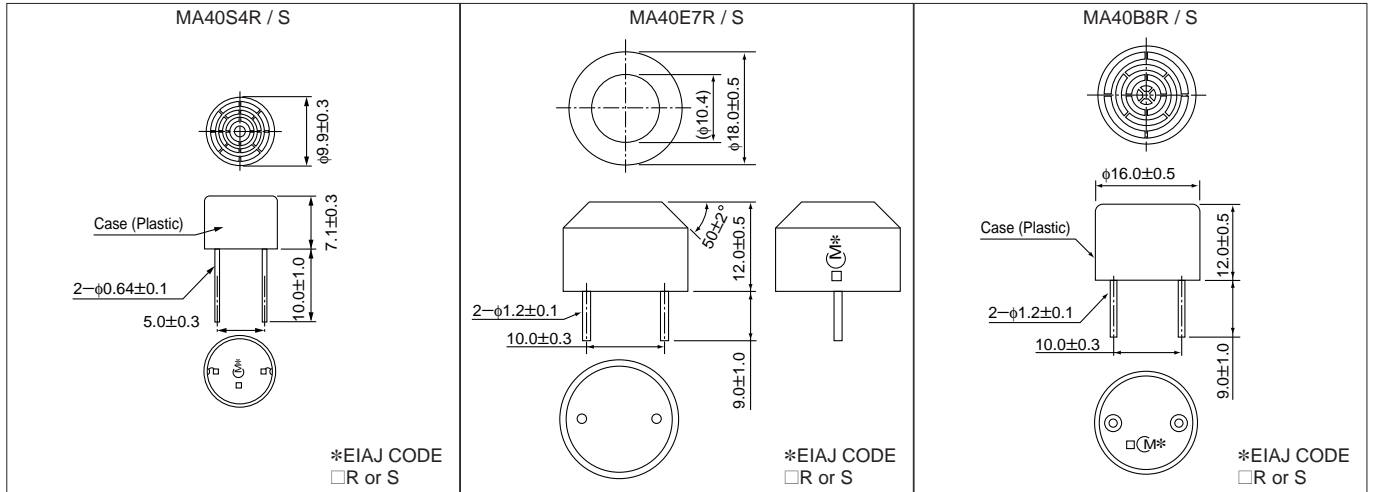

● COMBINED USE TYPE

(in mm)

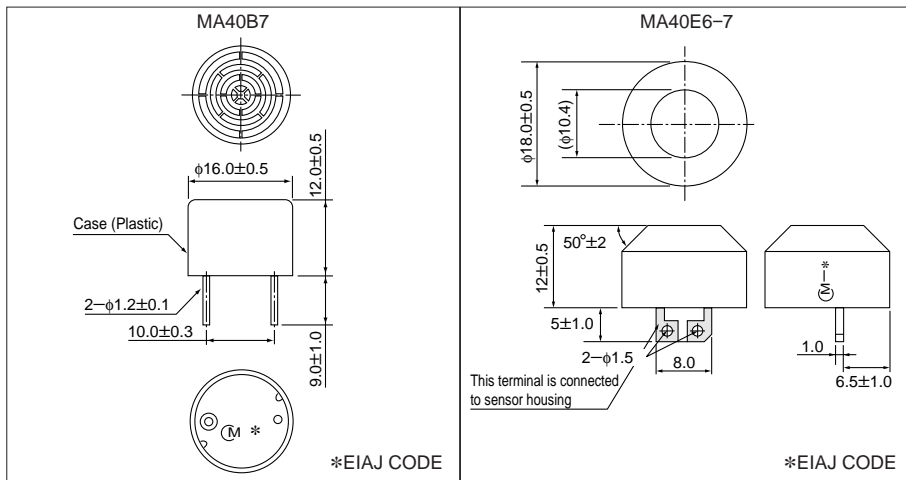

● COMBINED USE AND HIGH FREQUENCY TYPE

(in mm)

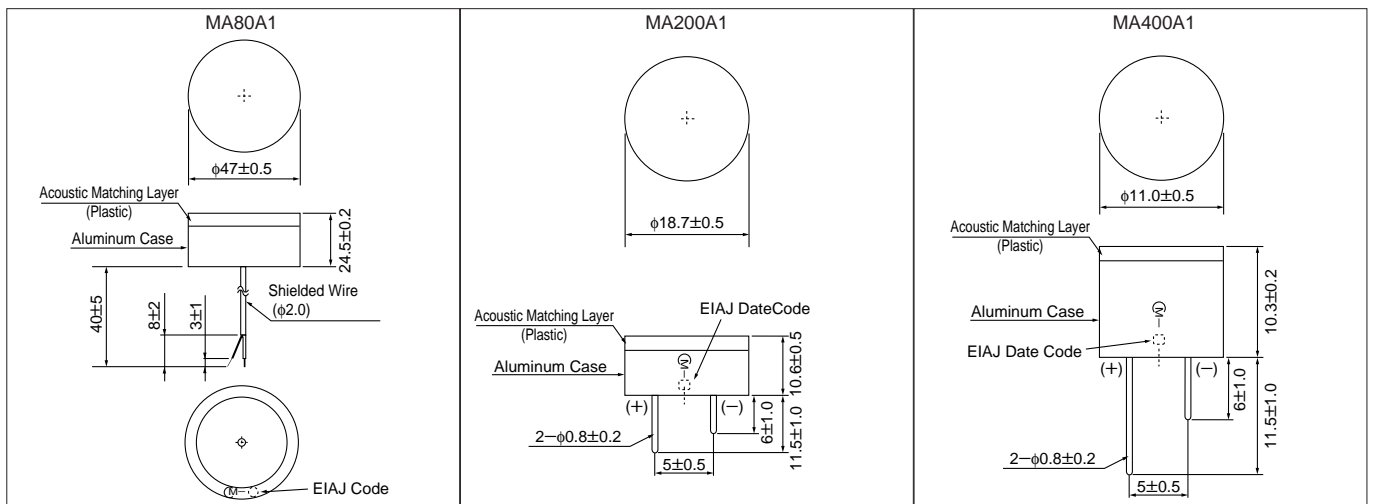

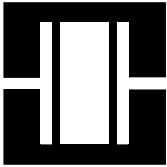

PIEZOTITE®



Ultrasonic Sensor MA Series

SENSITIVITY VS. FREQUENCY CHARACTERISTICS

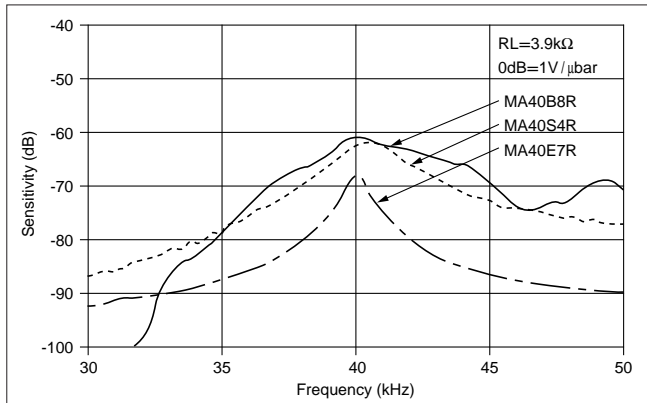

S.P.L VS. FREQUENCY CHARACTERISTICS

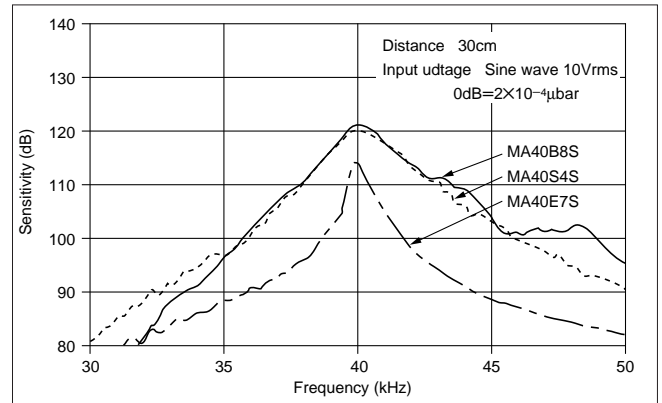

DIRECTIVITY

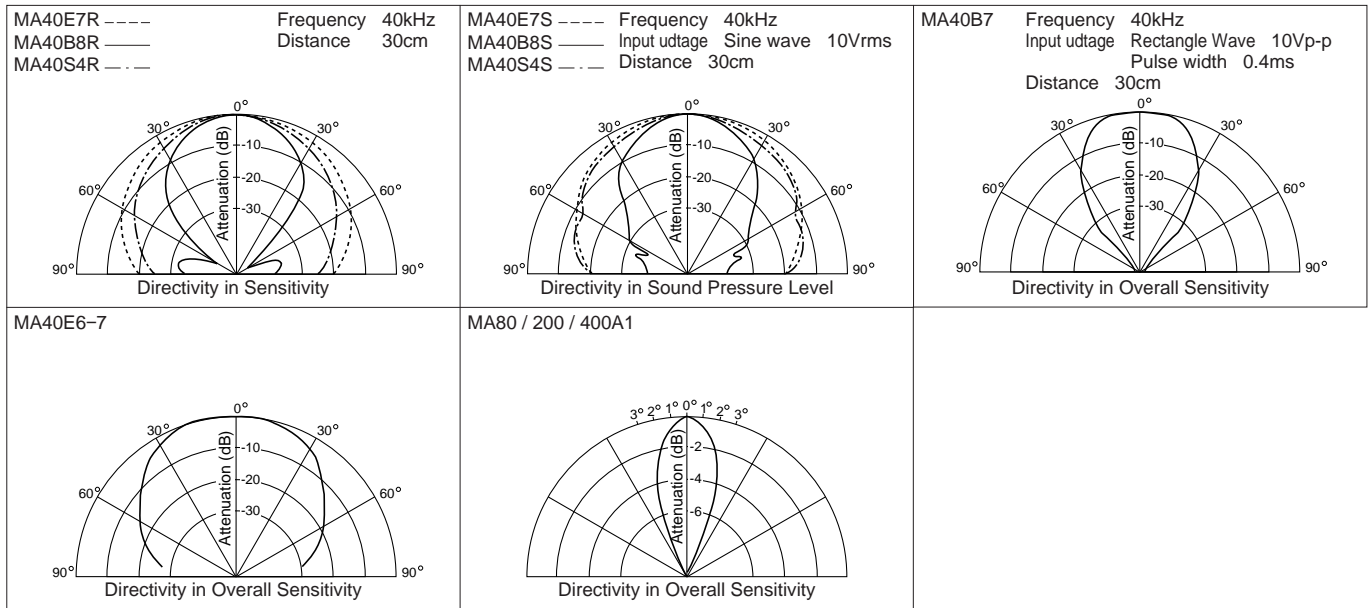

APPLICATION CIRCUIT

1. Pulse-transmitting Circuit

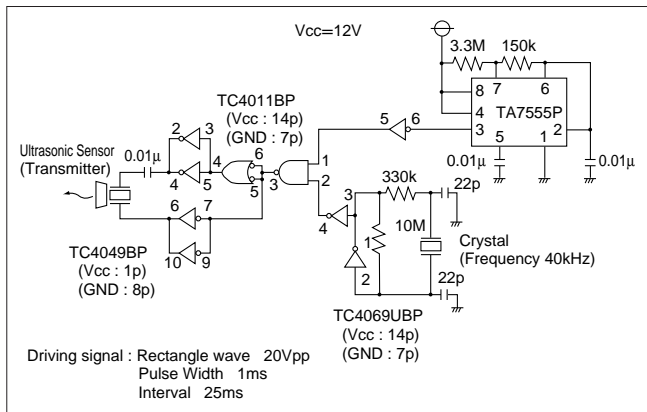

2. Receiving Circuit

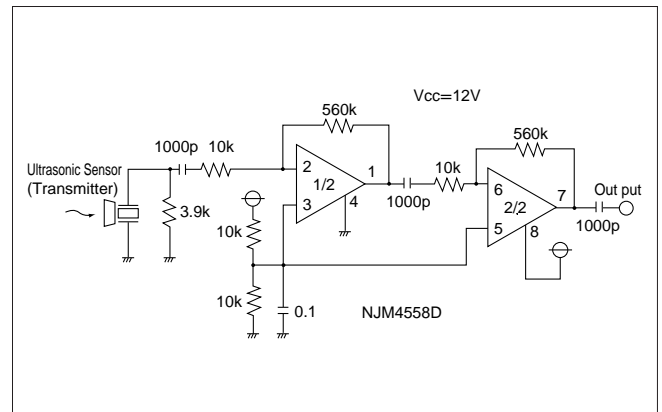

5

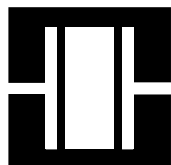
PIEZOTITE®
muRata
Ultrasonic Sensor MA Series
■ RATING

Part Number	MA40E7R / S	MA40S4R / S	MA40B8R / S	MA40B7	MA40E6-7
Construction	Water proof type	Open structure type			Water proof type
Using Method	Receiver and Transmitter (Dual use) type			Combined use type	
Nominal Frequency (kHz)	40				
Overall Sensitivity (dB)	—	—	—	-45 ± 4	—
Sensitivity (dB)	-74 min.	-63 ± 3	-63 ± 3	—	-82 min.
Sound Pressure (dB)	106 min.	120 ± 3	120 ± 3	—	108 min.
Directivity (deg)	100	80	50	44	75
Capacitance (pF)	$2200 \pm 20\%$	$2550 \pm 20\%$	$2000 \pm 20\%$	$2000 \pm 20\%$	$2200 \pm 20\%$
Operating Temperature Range (°C)	-30 to +85				
Detectable Range (m)	0.2 - 3	0.2 - 4	0.2 - 6	0.2 - 4	0.2 - 2
Resolution (mm)	9				
Dimension (mm)	18φ×12h	9.9φ×7.1h	16φ×12h	16φ×12h	18φ×12h
Weight (g)	4.5	0.7	2.0	2.0	4.5
Allowable Input Voltage (Vp-p) (Rectangular wave)	85 (40kHz)		20 (40kHz)	20 (40kHz)	100 (40kHz)
	Pulse width 0.4ms Interval 100ms	Continuous signal	Continuous signal	Pulse width 0.4ms Interval 100ms	140 (40kHz Sine wave) Pulse width 0.4ms Interval 100ms
Packing Unit (pcs.)	90	540	150	150	90

*Distance : 30cm. Overall sensitivity : 0dB=10Vpp, Sensitivity : 0dB=1V/μbar. Sound pressure level : 0dB=2×10⁻⁴μbar 1μbar=0.1Pa

*The sensor can be used in the operating temperature range. Please refer to the individual specification for the temperature drift of Sensitivity/Sound pressure level or environmental characteristics in that temperature range.

*Directivity, Detectable Range and Resolution is typical value. It can be changed by application circuit and fixing method of the sensor.

Part Number	MA80A1	MA200A1	MA400A1
Construction	High frequency type		
Using Method	Receiver and Transmitter (Dual use) type		
Center Frequency (kHz)	75±5	200±10	400±20
Overall Sensitivity (dB)	-47 min. 0dB=18 Vp-p (at 50cm)	-54 min. 0dB=18 Vp-p (at 20cm)	-74dB min. 0dB=18 Vp-p (at 10cm)
Directivity (deg)	7		
Operating Temperature Range (°C)	-10 to +60	-30 to +60	
Detectable Range (m)	0.5 - 5	0.2 - 1	0.06 - 0.3
Resolution (mm)	4	2	1
Dimension (mm)	47φ×24.5h	19φ×11h	11φ×10.5h
Weight (g)	93	6	2
Allowable Input Voltage (Vp-p) (Rectangular wave)	120 (75kHz)		120 (400kHz)
	Pulse width 600μs Interval 50ms	Pulse width 250μs Interval 20ms	Pulse width 125μs Interval 10ms
Packing Unit (pcs.)	5	90	224

*The sensor can be used in the operating temperature range. Please refer to the individual specification for the temperature drift of Sensitivity / Sound pressure level or environmental characteristics in that temperature range.

*Directivity, Detectable Range and Resolution is typical value. It can be changed by application circuit and fixing method of the sensor.

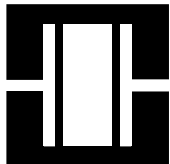

PIEZOTITE®



Ultrasonic Sensor MA Series

■NOTICE

1. Pay attention to the mounting position as these sensors have directivity.
2. Please avoid applying DC-bias by connecting DC blocking capacitor or some other way because, otherwise, the component may be damaged.
3. Do not use in the water.

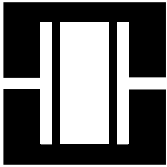

PIEZOTITE®



Shock Sensor

SMD Type PKGS-□□LA

The shock sensor generates a voltage which is proportional to applied shock (acceleration).

The PKGS series shock sensors use a Co-fired bimorph piezo elements clamped at the two-ends.

The sensors feature small size, low-profile, excellent shock resistance and high-sensitivity, and are surface mountable (SMD) withstanding the reflow soldering.

Three types of the sensors are available with inclined primary axis angle of 0°, 25° and 45° and are the best suited for small hard disk drives (HDD).

■FEATURES

1. Small size, low-profile, high-sensitivity and excellent shock resistance.
2. Reflow solderable SMD type.
3. Possible to be supplied in a tape.
4. Wide measurement frequency band due to high resonant frequency and large capacitance.
5. When mounted on a board, PKGS-25LA/PKGS-45LA can detect shocks in both horizontal and vertical axis directions.

■APPLICATIONS

1. Detection of shock to protect small HDD from damaging the data.
2. Shock detection and protection of home appliances, auto-visual equipment, industrial equipment, etc.
3. Burglar alarm systems.
4. Other general applications requiring measurement of acceleration.

■SPECIFICATIONS

Item \ Type	PKGS-00LA	PKGS-25LA	PKGS-45LA
Primary Axis Inclined Angle	0°	25°	45°
Voltage Sensitivity (Primary Axis Direction)	1.92mV / G±15%	1.75mV / G±15%	1.85mV / G±15%
Capacitance	210pF±20%	240pF±20%	295pF±20%
±3dB Frequency Band (Circuit Zi = 10MΩ)	76 - 10000Hz	50 - 10000Hz	65 - 10000Hz
Insulation Resistance	500MΩ min.		
Resonant Frequency	23kHz (typ.)		
Non-Linearity	1% (typ.)		
Transverse Sensitivity (Relative to Primary Sensitivity)	5% (typ.)		
Shock Resistance	1500G		
Operating and Storage Temperature Range	-40 to +85°C		

*1G=9.8m / s²

■NOTICE

1. Please avoid applying DC-bias by connecting DC blocking capacitor or some other way because, otherwise, the component may be damaged.
2. Please contact us for soldering and washing conditions.

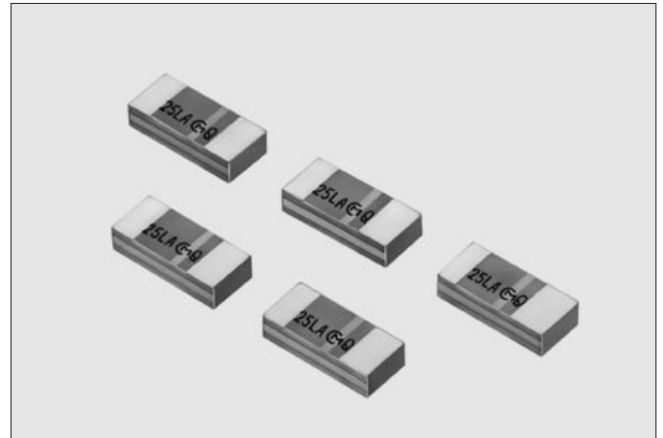

■DIMENSIONS

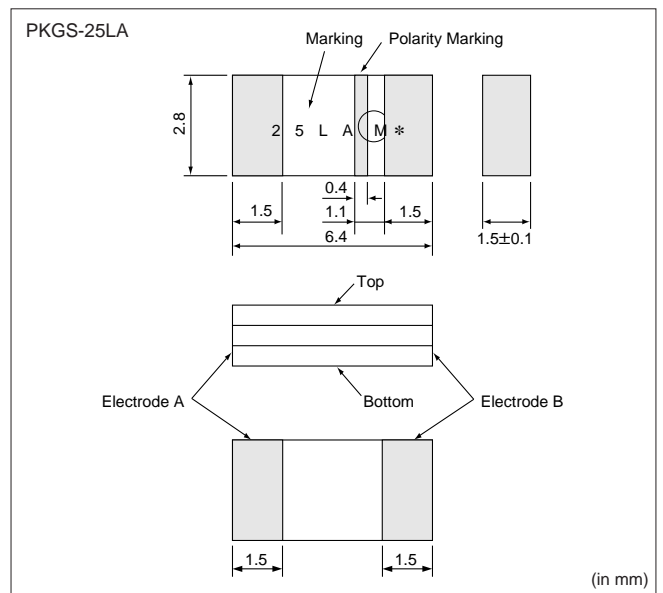

■PRIMARY AXIS INCLINED ANGLE

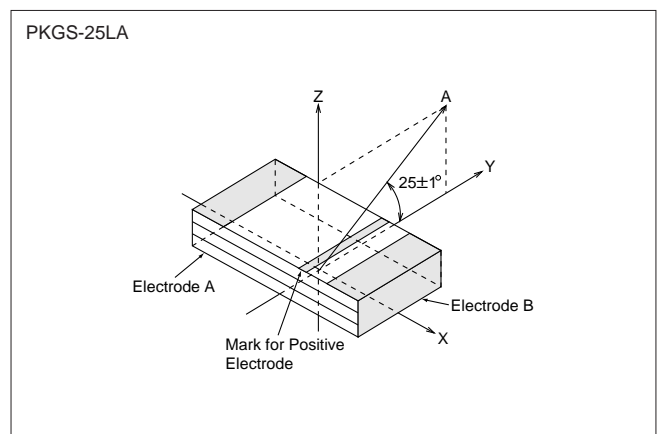



PIEZOTITE®



Shock Sensor

Thin and Small Type PKGS-□□LB

PKGS-LB series achieved a thickness of 1.2mm, maintaining the same sensitivity as the standard PKGS-LA series. Three types of the sensors are available with inclined primary axis angle of 0°, 25° and 45° and are the best suited for small hard disk drives (HDD).

■FEATURES

1. Small size, low-profile, high-sensitivity and excellent shock resistance.
2. Reflow solderable SMD type.
3. Possible to be supplied in a tape, and reel.
4. Wide measurement frequency band due to high resonant frequency and large capacitance.
5. When mounted on a board, PKGS-25MD/PKGS-45MD can detect shocks in both horizontal and vertical axis directions.

■APPLICATIONS

1. Detection of shock to protect small HDD from damaging the data.
2. Shock detection and protection of home appliances, audio-visual equipment, industrial equipment, etc.
3. Burglar alarm systems.
4. Other general applications requiring measurement of acceleration.

■SPECIFICATIONS

Item \ Type	PKGS-00LB	PKGS-25LB	PKGS-45LB
Primary Axis Inclined Angle	0°	25°	45°
Voltage Sensitivity (Primary Axis Direction)	1.85mV / G±15%	1.85mV / G±15%	1.93mV / G±15%
Capacitance	210pF±20%	240pF±20%	295pF±20%
±3dB Frequency Band (Circuit Zi = 10MΩ)	76 - 10000Hz	50 - 10000Hz	65 - 10000Hz
Insulation Resistance	500MΩ min.		
Resonant Frequency	20kHz (typ.)		
Non-Linearity	1% (typ.)		
Transverse Sensitivity (Relative to Primary Sensitivity)	5% (typ.)		
Shock Resistance	1500G		
Operating and Storage Temperature Range	-40 to +85°C		

*1G=9.8m / s²

■NOTICE

1. Please avoid applying DC-bias by connecting DC blocking capacitor or some other way because, otherwise, the component may be damaged.
2. Please contact us for soldering and washing conditions.



■DIMENSIONS

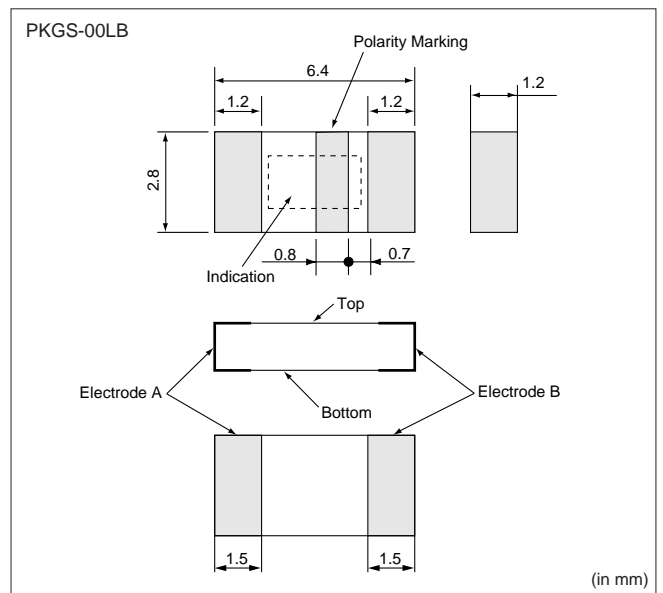

■PRIMARY AXIS INCLINED ANGLE

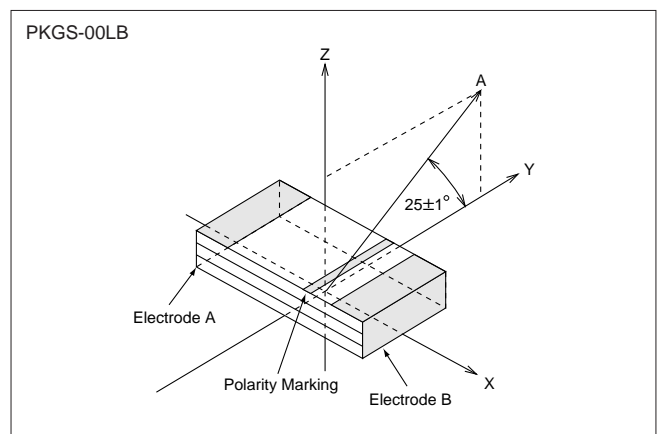

5

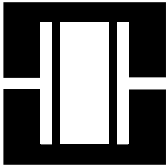

PIEZOTITE®



Shock Sensor

Small and Low-Profile Type PKGS-□□MD

PKGS-MD series achieved 55% reduction in volume compared with PKGS-LA series.

Three types of the sensors are available with inclined primary axis angle of 0°, 25° and 45° and are the best suited for small hard disk drives (HDD).

■FEATURES

1. Small size, low-profile, and excellent shock resistance.
2. Reflow solderable SMD type, and reel.
3. Possible to be supplied in a tape.
4. Wide measurement frequency band due to high resonant frequency.
5. When mounted on a board, PKGS-25MD/PKGS-45MD can detect shocks in both horizontal and vertical axis directions.

■APPLICATIONS

1. Detection of shock to protect small HDD from damaging the data.
2. Shock detection and protection of home appliances, audio-visual equipment, industrial equipment, etc.
3. Burglar alarm systems.
4. Other general applications requiring measurement of acceleration.

■SPECIFICATIONS

Item \ Type	PKGS-00MD	PKGS-25MD	PKGS-45MD
Primary Axis Inclined Angle	0°	25°	45°
Voltage Sensitivity (Primary Axis Direction)	0.85mV / G±15%	0.85mV / G±15%	0.89mV / G±15%
Capacitance	160pF±20%	170pF±20%	210pF±20%
±3dB Frequency Band (Circuit Zi = 10MΩ)	100 - 20000Hz	94 - 20000Hz	76 - 20000Hz
Insulation Resistance	500MΩ min.		
Resonant Frequency	30kHz (typ.)		
Non-Linearity	1% (typ.)		
Transverse Sensitivity (Relative to Primary Sensitivity)	5% (typ.)		
Shock Resistance	1500G		
Operating and Storage Temperature Range	-40 to +85°C		

*1G=9.8m / s²

■NOTICE

1. Please avoid applying DC-bias by connecting DC blocking capacitor or some other way because, otherwise, the component may be damaged.
2. Please contact us for soldering and washing conditions.

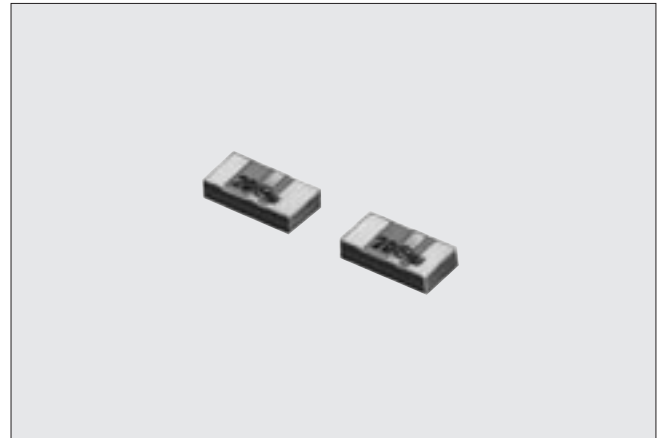

■DIMENSIONS

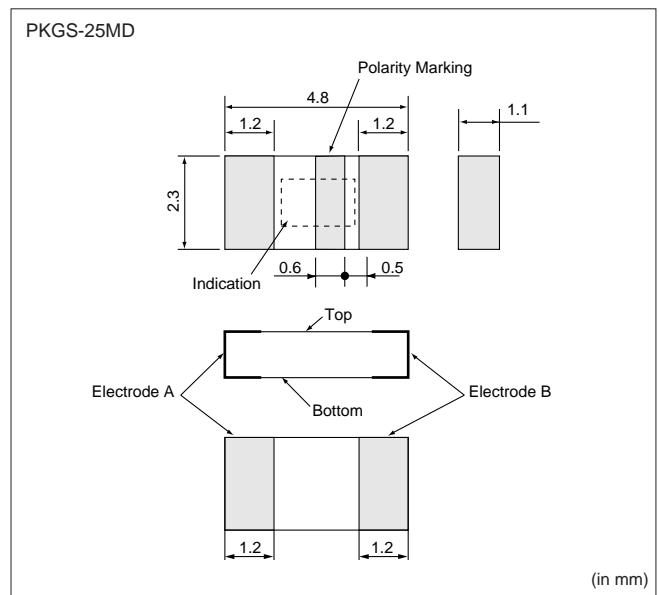

■PRIMARY AXIS INCLINED ANGLE

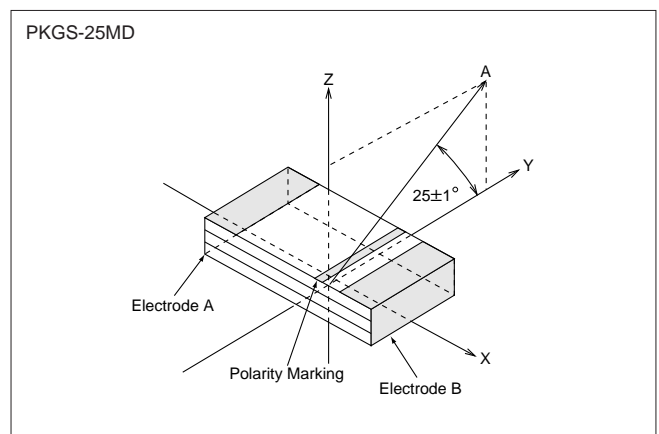



PIEZOTITE®



Shock Sensor

Large Capacitance Type PKGS-□□LC

PKGS-LC series is high capacitance type to sense lower frequency shock and vibration.

Two types of the sensors are available with primary axis angle of 0° and 90°.

FEATURES

1. Small size, low-profile, high-sensitivity and excellent shock resistance.
2. Reflow solderable SMD type.
3. Possible to be supplied in a tape and reel.
4. Wide measurement frequency band due to high resonant frequency and large capacitance.

APPLICATIONS

1. Detection of shock to protect small HDD from damaging the data.
2. Shock detection and protection of home appliances, audio-visual equipment, industrial equipment, etc ,
3. Burglar alarm systems.
4. Other general applications requiring measurement of acceleration.

SPECIFICATIONS

Item	Type	PKGS-00LC	PKGS-90LC
Primary Axis Inclined Angle		0°	90°
Voltage Sensitivity (Primary Axis Direction)		2.10mV / G±10%	2.10mV / G±10%
Capacitance		420pF±20%	420pF±20%
±3dB Frequency Band (Circuit Zi = 10MΩ)		37 - 10000HZ	
Insulation Resistance		500MΩ min.	
Resonant Frequency		20kHz (typ.)	
Non-Linearity		1% (typ.)	
Transverse Sensitivity (Relative to Primary Sensitivity)		5% (typ.)	
Shock Resistance		1500G	
Operating and Storage Temperature Range		-40 to +85°C	

*1G=9.8m / s²

NOTICE

1. Please avoid applying DC-bias by connecting DC blocking capacitor or some other way because, otherwise, the component may be damaged.
2. Please contact us for soldering and washing conditions.

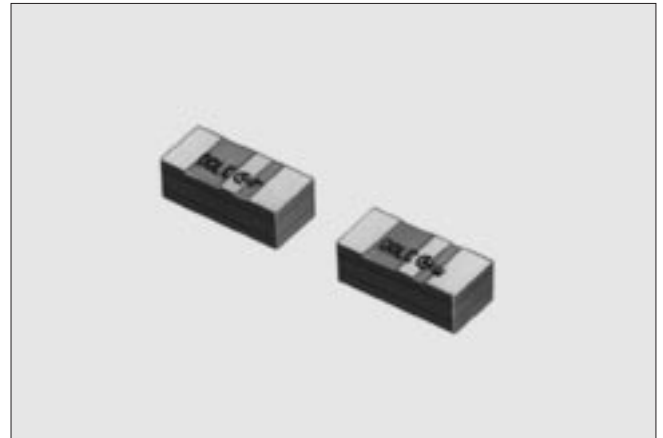

DIMENSIONS

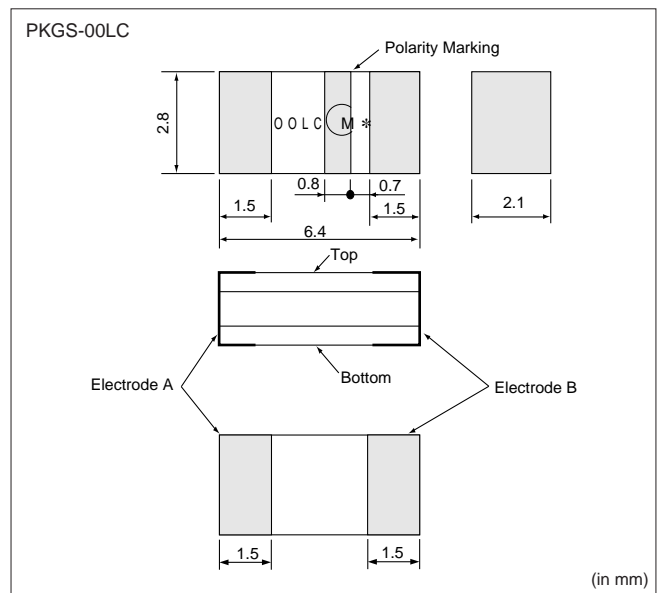

PRIMARY AXIS INCLINED ANGLE

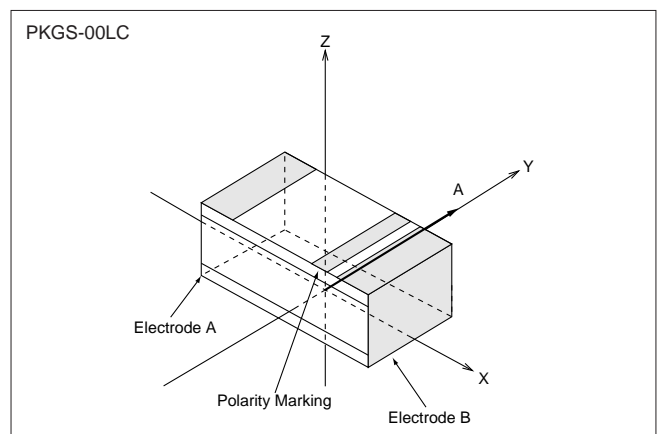

5

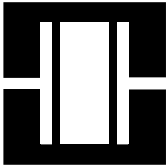

PIEZOTITE®

Shock Sensor



Lead Type PKS

The piezoelectric element produces a voltage which is proportional to the acceleration of an impact or a vibration to which it is exposed. The shock sensor utilizes piezoelectric ceramics to convert the energy of impact into a proportional electrical signal. The piezoelectric shock sensor uses a "unimorph" diaphragm which consists of a piezoelectric ceramic disk laminated to a metal disk. The diaphragm is supported along its circumference in a housing. The sensor features compact, lightweight design, and is suitable for a wide range of applications requiring impact and vibration sensing.

FEATURES

1. Compact, lightweight design.
2. High sensitivity assures it picks up even microlevel impact and vibration.
3. Rugged construction survive impact and vibration stresses.
4. Requires no bias voltage.

APPLICATIONS

1. Car burglar sensors on doors.
2. Intruder sensors at windows or doors.
3. Burglar alarms for showcases and safes.
4. Vibration sensors for car audio equipment.

SPECIFICATIONS

Part Number	PKS1-4A1 / PKS1-4A10
Output Voltage	40mVp / G typ.(25°C, 20MΩ Load, 10Hz - 1kHz)
Capacitance	10000pF±30%(25°C, 1kHz)
Insulation Resistance	30MΩ min.(100VDC)

*1G=9.8m / s²

NOTICE

1. The component should be fixed at the place where the main axis of sensor has same direction as the vibration axis.
2. Please avoid applying DC-bias by connecting DC blocking capacitor or some other way because, otherwise, the component may be damaged.

CHARACTERISTICS DATA

Frequency Response

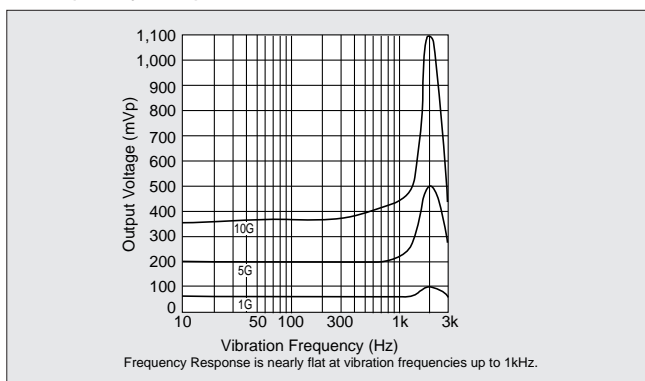

DIMENSIONS

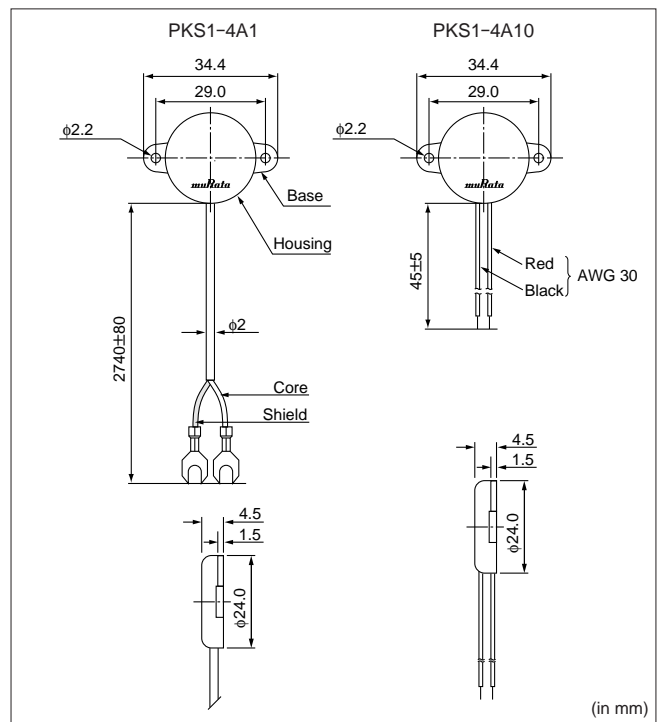

Output Voltage vs. Impact Response

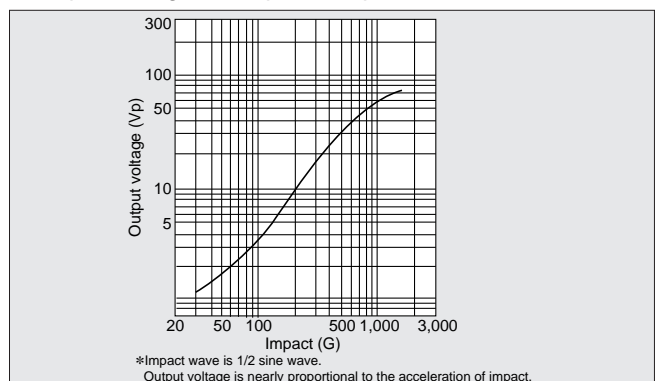



PIEZOTITE®



Knocking Sensor Elements

The knocking sensor senses abnormal vibrations in an automobile engine. The sensor provides a feedback signal to the engine control system to suppress the knocking. Knocking sensors include a resonant type and a non-resonant type-both of which use piezoelectric elements. Murata offers highly-stable piezoelectric elements for use in knocking sensors which are directly mounted on the engine. Design emphasis is placed on heat-resistant, stress-resistant performance to ensure endurance in the harsh operation environment under the hood. Shape and dimensions are variable according to customer needs.



FEATURES

1. Provides output voltage proportional to acceleration of vibration.
2. Flat frequency response makes these sensors applicable to any type of engine (for non-resonant type).

APPLICATIONS

Knocking sensors for automobile engines.

SPECIFICATIONS AND DIMENSIONS (Typical value)

Part Number	6CC-10-3R9-1000-1	6CC-10-4R9-1000	7D-25-1600	4C-19R5-15R3-5300
Resonant Frequency(kHz)	180	165	80	5300
Capacitance (pF)	230	220	6900	470
Electromechanical Coupling Coefficient (%)	20	23	55	56
Dimensions (mm)				
Applications	Non-Resonant Type	Non-Resonant Type	Resonant Type	Non-Resonant Type

NOTICE

1. Do not touch the component with bare hand because the electrode may be damaged.
2. The component may be damaged if it is used in any application that deviates from its intended use noted within the specification.
3. Please avoid applying DC-bias by connecting DC blocking capacitor or some other way because, otherwise, the component may be damaged.

5



PIEZOTITE®



Ultrasonic Bubble Sensor

Senses the Bubbles in Tubes

The ultrasonic bubble sensor emits an ultrasonic wave into a fluid then senses waves reflected from bubbles.

FEATURES

1. Small and light
2. High sensitivity
3. Low power consumption
4. High durability

APPLICATIONS

1. Senses the bubbles or fluids in tubes, e.g. vending machines.



TEST METHOD

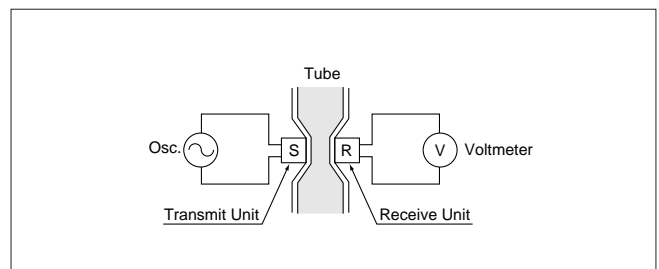

SPECIFICATIONS AND DIMENSIONS (Typical value)

Part Number	PKH3-512A1R	PKH3-512A1S	PKH3-512B1R	PKH3-512B1S
Nominal Frequency (kHz)	512	512	512	512
Capacitance (pF)	150	450	280	220
Electromechanical Coupling Coefficient (%)	20	23	55	56
Dimensions (mm)				

NOTICE

1. Please avoid applying DC-bias by connecting DC blocking capacitor or some other way because, otherwise, the component may be damaged.
2. Characteristics can be changed by fixing method. Please contact us.

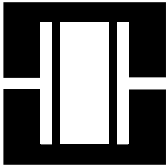

PIEZOTITE®



Electric Potential Sensor

Every object has its own surface electrical charges or charges given to it from other objects. These electrical charges cause the object to have a certain electric potential with respect to other objects.

The electric potential sensor is designed to measure this surface potential. there are two major surface potential detection methods : The field-mill method and the vibrating capacitance method.

The former method synchronously shuts off the electrical flux from the object surface and modulates the electric field incident to the sensing electrode to induce an AC current on the electrode, proportional to the surface potential (DC).

The latter method forms a capacitance across the surface of the object and the sensing electrode, and vibrates the sensing electrode vertically the surface of object to induce electrical charges which are proportional to the capacitance and surface potential, thereby obtaining an AC current proportional to the surface potential (DC). Murata's potential sensors, use a high-precision, piezoelectric tuning fork (Microfork) with a proven production record, to achieve field shut-off vibration and electrode vibration. Integrating all of the signal processing circuit, Murata's electric potential sensor assures high operating stability and reliability.

FEATURES

1. Compact, low-profile design.
2. DC voltage output.
3. High-precision linear output and highly stable.
4. Integrates all signal processing blocks, including oscillation, amplifying and rectifying circuit.

APPLICATIONS

1. Sensing of surface electric potential for photosensitive drums used in PPC machines and laser beam printers.
2. High voltage measurement and detection for high voltage equipment.

SPECIFICATIONS

Part Number	PKE05A1
Supply Voltage	24VD.C.±10%
Current Consumption	50mA max.
Detectable Electric Potential	Positive electric potential of 0 to 1500V.
Output Voltage	1/240 VD.C. of the objective potential regarding detail condition, please ask them to us.
Linearity	For objective potential from 50 V to 1500V : ±1.5% max.

* Detection for negative electric potential are also available.

NOTICE

Please insure the component is thoroughly evaluated in your application circuit because the output voltage and the distance are correlated.



DIMENSIONS

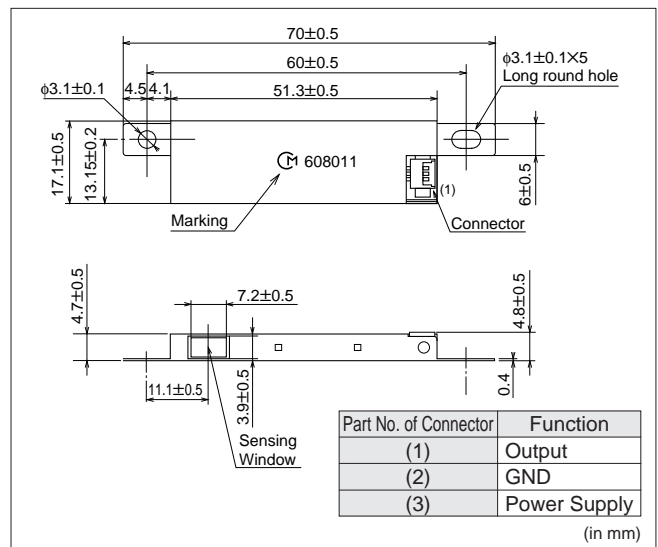

CIRCUIT CONFIGURATION

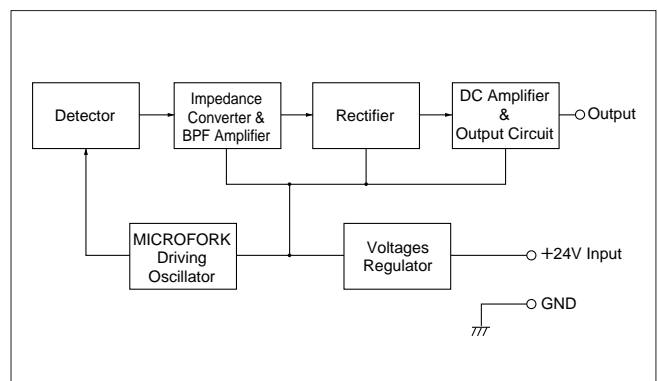

5



PIEZOTITE®



Electric Potential Sensor

■ CHARACTERISTICS DATA

● Output Voltage vs. Objective Potential

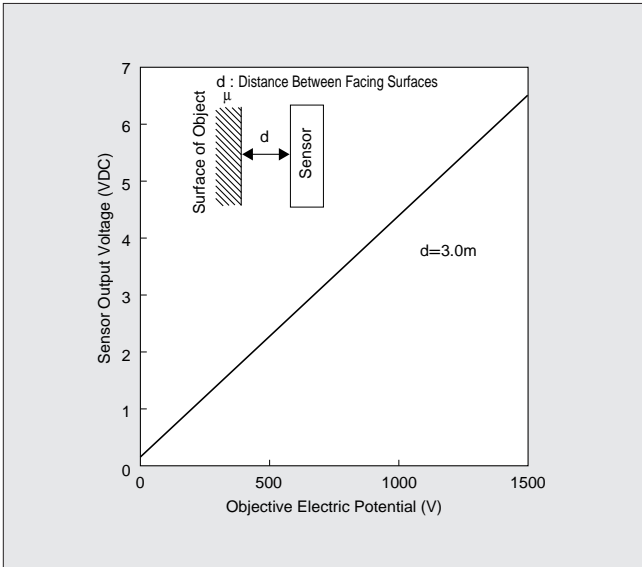

● Temperature Characteristics

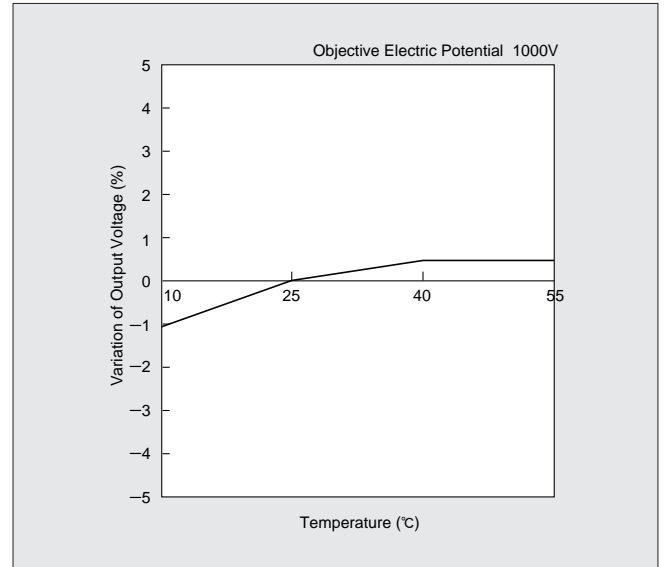

5

**Note:**

1. Export Control
〈For customers outside Japan〉
Murata products should not be used or sold for use in the development, production, stockpiling or utilization of any conventional weapons or mass-destructive weapons (nuclear weapons, chemical or biological weapons, or missiles), or any other weapons.
〈For customers in Japan〉
For products which are controlled items subject to “the Foreign Exchange and Foreign Trade Control Law” of Japan, the export license specified by the law is required for export.
 2. Please contact our sales representatives or engineers before using our products listed in this catalog for the applications requiring especially high reliability what defects might directly cause damage to other party's life, body or property (listed below) or for other applications not specified in this catalog.
 - ① Aircraft equipment
 - ② Aerospace equipment
 - ③ Undersea equipment
 - ④ Medical equipment
 - ⑤ Transportation equipment (automobiles, trains, ships,etc.)
 - ⑥ Traffic signal equipment
 - ⑦ Disaster prevention / crime prevention equipment
 - ⑧ Data-processing equipment
 - ⑨ Applications of similar complexity or with reliability requirements comparable to the applications listed in the above
 3. Product specifications in this catalog are as of June 1997, and are subject to change or stop the supply without notice. Please confirm the specifications before ordering any product. If there are any questions, please contact our sales representatives or engineers.
 4. The categories and specifications listed in this catalog are for information only. Please confirm detailed specifications by checking the product specification document or requesting for the approval sheet for product specification, before ordering.
 5. Please note that unless otherwise specified, we shall assume no responsibility whatsoever for any conflict or dispute that may occur in connection with the effect of our and/or third party's intellectual property rights and other related rights in consideration of your using our products and/or information described or contained in our catalogs. In this connection, no representation shall be made to the effect that any third parties are authorized to use the rights mentioned above under licenses without our consent.
 6. None of ozone depleting substances (ODS) under the Montreal Protocol is used in manufacturing process of us.
-

***muRata* Murata Manufacturing Co., Ltd.**

Head office

2-26-10, Tenjin Nagaokakyo-shi, Kyoto 617-8555, Japan Phone:81-75-951-9111

Marketing Group1874 Sumiyoshi-cho Kizuki, Nakahara-ku Kawasaki, 211-0021, Japan
Phone:81-44-422-5153 Fax:81-44-433-0798