

Chip Coils

CHIP COILS

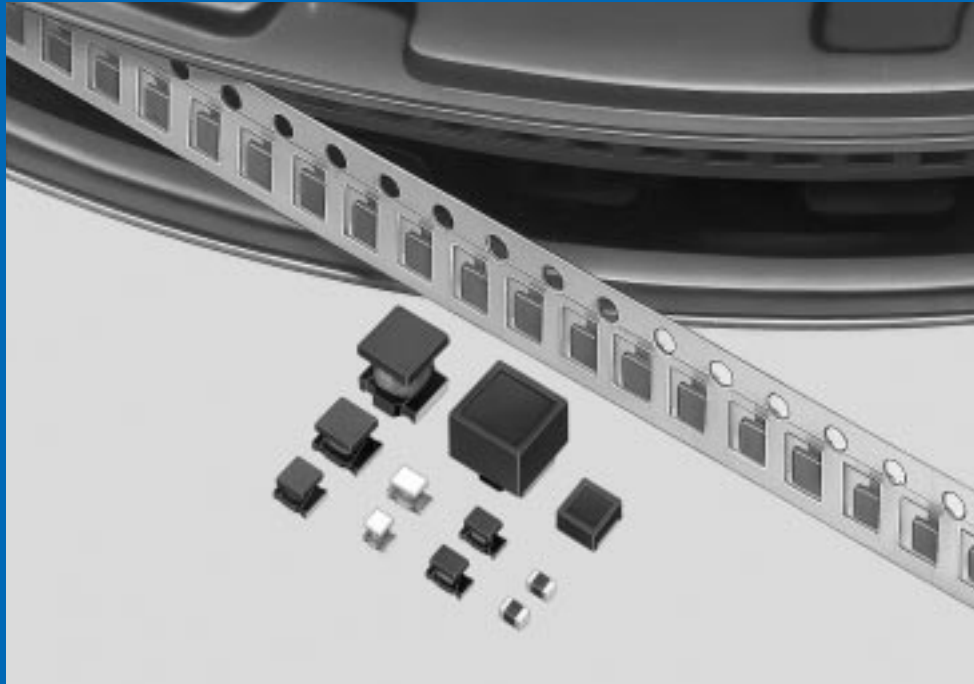

Murata
Manufacturing Co., Ltd.

Cat.No.O05E-7

CONTENTS

Part Numbering	_____	2
Products Guide	_____	4
Selection Guide	_____	5
High-frequency		
1 Monolithic Type	LQG15H/LQG18H Series _____	6
2 Film Type	LQP03T/LQP15T/LQP15M/LQP18M Series _____	9
3 Winding Type	LQW15A/LQW18A Series _____	16
4 Winding Type	LQW2BH/LQW31H Series _____	22
5 Winding Type	LQH31H Series _____	26
for General Use		
6 Monolithic Type	LQM18N/LQM21N Series _____	27
7 Winding Type	LQH31M/LQH32M/LQH43M (N) Series _____	31
8 Magnetic Shielded Type	LQH3ER Series _____	37
for Choke		
9 Monolithic Type	LQM21D/LQM21F/LQM31F Series _____	39
10 Winding Type	LQH31C/LQH32C/LQH43C Series _____	42
11 Magnetic Shielded Type	LQH3KS Series _____	47
12 Winding/Magnetic Shielded Type	LQH55D/LQH66S Series _____	48
Notice(Soldering and Mounting)		
	Monolithic And Film Type (LQG/LQM/LQP Series) _____	51
	Winding Type (LQW/LQH31/LQH43 Series) _____	54
	Winding And Magnetic Shielded Type (LQH32/LQH3ER/LQH3KS Series) _____	58
	Large-current Type (LQH55D/LQH66S Series) _____	61
Notice	_____	63
Packaging	_____	65
Design Kits	_____	67
Information	_____	77

1

2

3

4

5

6

7

8

9

10

11

12

● **Part Numbering** (The structure of the "Global Part Numbers" that have been adopted since June 2001 and the meaning of each code are described herein.)
 (If you have any questions about details, inquire at your usual Murata sales office or distributor.)

Chip Coils (SMD)

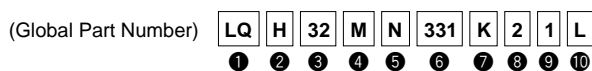

① Product ID

Product ID	
LQ	Chip Coils

② Structure

Code	Structure
G	Monolithic Type (Air-core Coil)
H	Winding Type (Ferrite Core)
M	Monolithic (Ferrite Core)
P	Film Type
W	Winding Type (Air-core Coil)

③ Dimension (L×W)

Code	Dimension (L×W)	EIA
03	0.6×0.3mm	0201
15	1.0×0.5mm	0402
18	1.6×0.8mm	0603
21	2.0×1.25mm	0805
2B	2.0×1.5mm	0805
31	3.2×1.6mm	1206
32	3.2×2.5mm	1210
3E	3.5×3.2mm	1214
3K	3.3×3.3mm	1212
43	4.5×3.2mm	1812
55	5.7×5.0mm	2220
66	6.3×6.3mm	2525

④ Applications and Characteristics

Code	Series	Applications and Characteristics
H	LQG	Monolithic Air-core
N	LQM	for Resonant Circuit
D		for Choke (Low-current DC Power Supplies)
F		for Choke (DC Power Supplies)
M	LQP	Film Type
T		Film Type (Low DC Resistance Type)
A	LQW	High Q Type (UFH-SHF)
H		High Q Type (VHF-UHF)
N	LQH	for Resonant Circuit
M		for Resonant Circuit (Coating Type)
R		for Resonant Circuit (Magnetically Shielded Type)
D		for Choke
C		for Choke (Coating Type)
S		for Choke (Magnetically Shielded Type)
H		for High-frequency Resonant Circuit

⑤ Category

Code	Category
N	Standard Type

⑥ Inductance

Expressed by three figures. The unit is micro-henry (μH). The first and second figures are significant digits, and the third figure expresses the number of zeros which follow the two figures. If there is a decimal point, it is expressed by capital letter "R". In this case, all figures are significant digits. If inductance is less than 0.1μH, the inductance code is expressed by combination of two figures and capital letter "N", and the unit of inductance is nano-henry (nH).

Capital letter "N" indicates the unit of "nH", and also expresses a decimal point. In this case, all figures are significant digits.

⑦ Inductance Tolerance

Code	Inductance Tolerance
B	±0.1nH
C	±0.2nH
D	±0.5nH
G	±2%
H	±3%
J	±5%
K	±10%
M	±20%
N	±30%
S	±0.3nH
W	±0.05nH

⑧ Features

Expressed by a figure from "0" to "2".

Ex.)

Code	Features
0	Standard Type

⑨ Electrode

Code	Electrode
0	Solder etc
1	Ni alloy + Solder
2	Sn

Continued on the following page.

 Continued from the preceding page.

(Global Part Number) **LQ** **H** **32** **M** **N** **331** **K** **2** **1** **L**
 ① ② ③ ④ ⑤ ⑥ ⑦ ⑧ ⑨ ⑩

⑩ Packaging

Code	Packaging	Series
K	Plastic Taping (ø330mm Reel)	LQH*1 /LQW□□H/LQM31F/LQM21*2
L	Plastic Taping (ø180mm Reel)	LQH/LQW□□H/LQM31F/LQM21*2
B	Bulk	All series
J	Paper Taping (ø330mm Reel)	LQW18A/LQG/LQM18N/LQM21*3 /LQP18M
D	Paper Taping (ø180mm Reel)	LQW□□A/LQG/LQM18N/LQM21*3 /LQP

*1 Except LQH43C/LQH66S/LQH3ER

*2 LQM21D(22 - 47μH)/LQM21F(4.7 - 47μH)/LQM21N(2.7 - 4.7μH) only.

*3 LQM21D(1.0 - 10μH)/LQM21F(1.0 - 2.2μH)/LQM21N(0.1 - 2.2μH) only.

Products Guide

Murata's LQ□ series of chip coils consists of compact, high-performance inductors. Their innovative coil and case structures mean low DC resistance and outstanding high-frequency characteristics. The series is designed for a variety of applications, facilitating component selection for individual circuit requirements.

Application	Part Number	Structure	Dimensions		Inductance Range (H)							Page	
			(mm)	(inch)	1n	10n	100n	1μ	10μ	100μ	1m		10m
for High-frequency	LQG15H	Monolithic Type	1.0 ±0.5	0402								6-8	
	LQG18H		1.6 ±0.8	0603									
	Tight inductance tolerance	LQP03T	Film Type	0.6 ±0.3	0201								9-15
		LQP15T		1.0 ±0.5	0402								
		LQP15M		1.0 ±0.5	0402								
		LQP18M		1.6 ±0.8	0603								
		LQW15A	Winding Type (air core)	1.0 ±0.5	0402								16-21
		LQW18A		1.6 ±0.8	0603								
		LQW2BH		2.0 ±1.5	0805								
	LQW31H		3.2 ±1.6	1206								22-25	
LQH31H	Winding Type (ferrite core)	3.2 ±1.6	1206								26		
for General Use	LQH31M	Winding Type (ferrite core)	3.2 ±1.6	1206								31-36	
	LQH32M		3.2 ±2.5	1210									
	LQH43M(N)		4.5 ±3.2	1812									
	LQM18N	Magnetically shielded monolithic Type	1.6 ±0.8	0603								27-30	
	LQM21N		2.0 ±1.25	0805									
Tight inductance tolerance	LQH3ER	Magnetically shielded Type	3.2 ±3.5	1214								37-38	
for Choke	LQH31C	Winding Type	3.2 ±1.6	1206								42-46	
	LQH32C		3.2 ±2.5	1210									
	LQH32C_51		3.2 ±2.5	1210									
	LQH43C		4.5 ±3.2	1812									
	LQM21D	Magnetically shielded monolithic Type	2.0 ±1.25	0805								39-41	
	LQM21F		2.0 ±1.25	0805									
	LQM31F		3.2 ±1.6	1206									
	LQH55D	Winding Type	5.7 ±5.0	2220								48-49	
	LQH3KS	Magnetically shielded Type	3.3 ±3.3	1212								47	
	LQH66S		6.3 ±6.3	2525								49-50	

Selection Guide

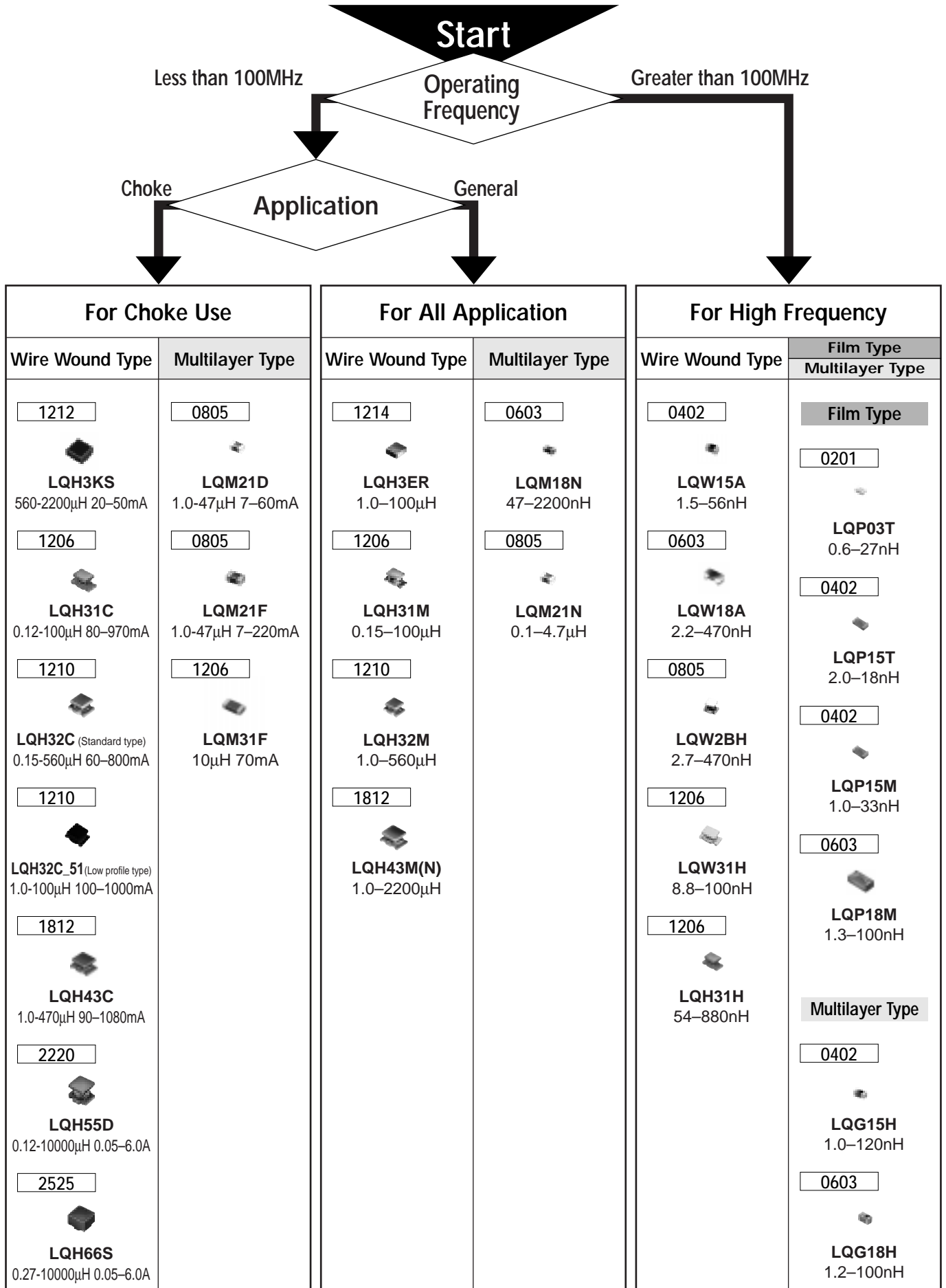

Chip Coils



High-frequency Monolithic Type LQG15H/LQG18H Series

LQG15H Series

The LQG15H series are chip inductors specifically, designed for high frequency applications. The LQG15H series is designed to realize stable characteristics in high frequency range applying intergrated multilayer process. The integrated multilayer process enables a wide range of inductance values with thigt tolerance.

■ Features

1. High-Q, stable inductance in high frequency is achieved by the unique low-capacitance structure. It is suitable for mobile communication equipment.
2. The small size of LQG15H (1.0x0.5x0.5mm) is ideal for small mobile equipment.
3. The external electrodes with nickel barrier structure provide excellent solder heat resistance.

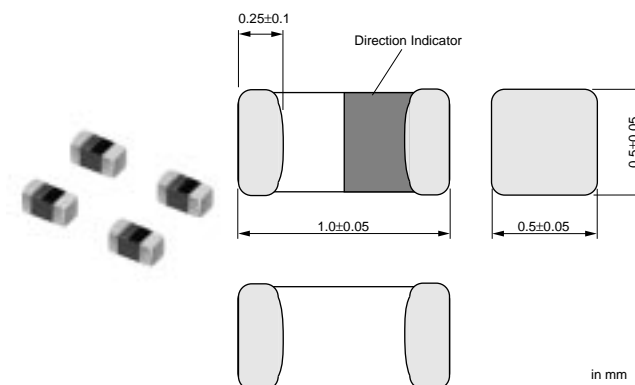

Part Number	Inductance (nH)	Test Frequency (MHz)	Rated Current (mA)	DC Resistance (ohm)	Q (min.)	Test Frequency (MHz)	Self Resonance Frequency (MHz)	EIA
LQG15HN1N0S02	1.0 ±0.3nH	100	200	0.10 max.	8	100	6000 min.	0402
LQG15HN1N1S02	1.1 ±0.3nH	100	200	0.10 max.	8	100	6000 min.	0402
LQG15HN1N2S02	1.2 ±0.3nH	100	200	0.10 max.	8	100	6000 min.	0402
LQG15HN1N3S02	1.3 ±0.3nH	100	200	0.10 max.	8	100	6000 min.	0402
LQG15HN1N5S02	1.5 ±0.3nH	100	200	0.10 max.	8	100	6000 min.	0402
LQG15HN1N6S02	1.6 ±0.3nH	100	200	0.10 max.	8	100	6000 min.	0402
LQG15HN1N8S02	1.8 ±0.3nH	100	200	0.10 max.	8	100	6000 min.	0402
LQG15HN2N0S02	2.0 ±0.3nH	100	200	0.12 max.	8	100	6000 min.	0402
LQG15HN2N2S02	2.2 ±0.3nH	100	200	0.15 max.	8	100	6000 min.	0402
LQG15HN2N4S02	2.4 ±0.3nH	100	200	0.16 max.	8	100	6000 min.	0402
LQG15HN2N7S02	2.7 ±0.3nH	100	200	0.17 max.	8	100	6000 min.	0402
LQG15HN3N0S02	3.0 ±0.3nH	100	200	0.18 max.	8	100	6000 min.	0402
LQG15HN3N3S02	3.3 ±0.3nH	100	200	0.19 max.	8	100	6000 min.	0402
LQG15HN3N6S02	3.6 ±0.3nH	100	200	0.19 max.	8	100	6000 min.	0402
LQG15HN3N9S02	3.9 ±0.3nH	100	200	0.19 max.	8	100	6000 min.	0402
LQG15HN4N3S02	4.3 ±0.3nH	100	200	0.21 max.	8	100	6000 min.	0402
LQG15HN4N7S02	4.7 ±0.3nH	100	200	0.23 max.	8	100	6000 min.	0402
LQG15HN5N1S02	5.1 ±0.3nH	100	200	0.24 max.	8	100	6000 min.	0402
LQG15HN5N6S02	5.6 ±0.3nH	100	200	0.26 max.	8	100	5300 min.	0402
LQG15HN6N2S02	6.2 ±0.3nH	100	200	0.27 max.	8	100	4300 min.	0402
LQG15HN6N8J02	6.8 ±5%	100	200	0.29 max.	8	100	4200 min.	0402
LQG15HN7N5J02	7.5 ±5%	100	200	0.31 max.	8	100	3900 min.	0402
LQG15HN8N2J02	8.2 ±5%	100	200	0.33 max.	8	100	3600 min.	0402
LQG15HN9N1J02	9.1 ±5%	100	200	0.34 max.	8	100	3400 min.	0402
LQG15HN10NJ02	10 ±5%	100	200	0.35 max.	8	100	3200 min.	0402
LQG15HN12NJ02	12 ±5%	100	200	0.41 max.	8	100	2800 min.	0402
LQG15HN15NJ02	15 ±5%	100	200	0.46 max.	8	100	2300 min.	0402
LQG15HN18NJ02	18 ±5%	100	200	0.51 max.	8	100	2100 min.	0402
LQG15HN22NJ02	22 ±5%	100	200	0.58 max.	8	100	1800 min.	0402
LQG15HN27NJ02	27 ±5%	100	200	0.67 max.	8	100	1600 min.	0402
LQG15HN33NJ02	33 ±5%	100	200	0.67 max.	8	100	1500 min.	0402

Continued on the following page.

Continued from the preceding page.

Part Number	Inductance (nH)	Test Frequency (MHz)	Rated Current (mA)	DC Resistance (ohm)	Q (min.)	Test Frequency (MHz)	Self Resonance Frequency (MHz)	EIA
LQG15HN39NJ02	39 ±5%	100	150	1.06 max.	8	100	1200 min.	0402
LQG15HN47NJ02	47 ±5%	100	150	1.15 max.	8	100	1000 min.	0402
LQG15HN56NJ02	56 ±5%	100	150	1.20 max.	8	100	800 min.	0402
LQG15HN68NJ02	68 ±5%	100	150	1.25 max.	8	100	800 min.	0402
LQG15HN82NJ02	82 ±5%	100	150	1.60 max.	8	100	600 min.	0402
LQG15HNR10J02	100 ±5%	100	150	1.60 max.	8	100	600 min.	0402
LQG15HNR12J02	120 ±5%	100	150	1.60 max.	8	100	600 min.	0402

Operating Temp. Range : -40°C to 85°C

Q-Frequency Characteristics

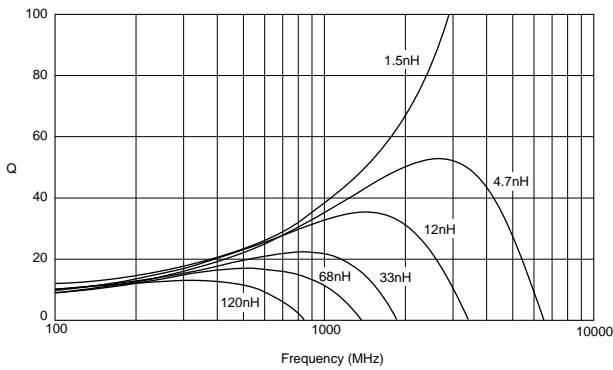

Inductance-Frequency Characteristics

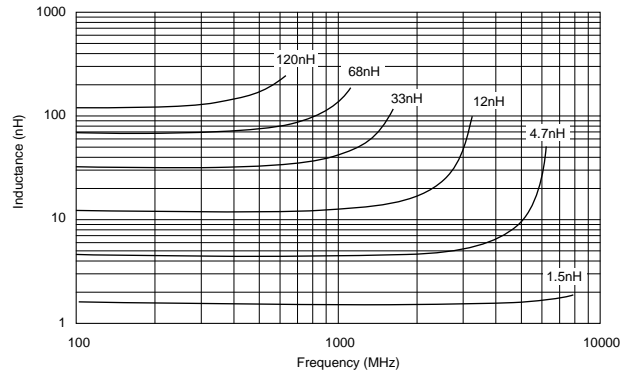

LQG18H Series

The LQG18H series is designed to realize stable characteristics in high frequency range applying intergrated multilayer process.

Features

1. High-Q, stable inductance in high frequency is available due to its original low-capacitance structure. It is suitable for small handy equipment, especially for card size equipment.
2. Small size of LQG18H (1.6x0.8x0.8mm) is suitable for small handy equipment, especially for card size equipment.
3. The external electrodes with nickel barrier structure provide excellent solder heat resistance.

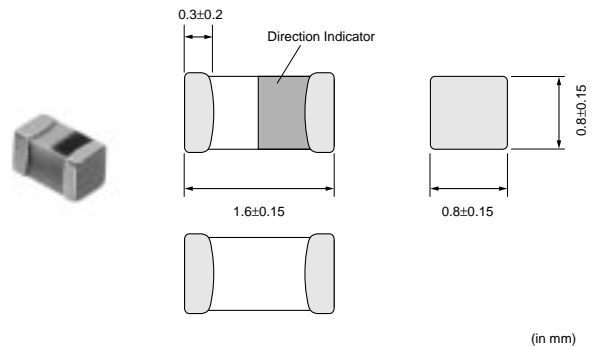

Part Number	Inductance (nH)	Test Frequency (MHz)	Rated Current (mA)	DC Resistance (ohm)	Q (min.)	Test Frequency (MHz)	Self Resonance Frequency (MHz)	EIA
LQG18HN1N2S00	1.2 ±0.3nH	100	300	0.10 max.	12	100	6000 min.	0603
LQG18HN1N5S00	1.5 ±0.3nH	100	300	0.10 max.	12	100	6000 min.	0603
LQG18HN1N8S00	1.8 ±0.3nH	100	300	0.10 max.	12	100	6000 min.	0603
LQG18HN2N2S00	2.2 ±0.3nH	100	300	0.10 max.	12	100	6000 min.	0603
LQG18HN2N7S00	2.7 ±0.3nH	100	300	0.15 max.	12	100	6000 min.	0603
LQG18HN3N3S00	3.3 ±0.3nH	100	300	0.15 max.	12	100	6000 min.	0603
LQG18HN3N9S00	3.9 ±0.3nH	100	300	0.15 max.	12	100	6000 min.	0603
LQG18HN4N7S00	4.7 ±0.3nH	100	300	0.20 max.	12	100	6000 min.	0603
LQG18HN5N6S00	5.6 ±0.3nH	100	300	0.20 max.	12	100	5000 min.	0603
LQG18HN6N8J00	6.8 ±5%	100	300	0.25 max.	12	100	5000 min.	0603
LQG18HN8N2J00	8.2 ±5%	100	300	0.25 max.	12	100	4000 min.	0603
LQG18HN10NJ00	10 ±5%	100	300	0.30 max.	12	100	3500 min.	0603
LQG18HN12NJ00	12 ±5%	100	300	0.35 max.	12	100	3000 min.	0603

Continued on the following page.

Continued from the preceding page.

Part Number	Inductance (nH)	Test Frequency (MHz)	Rated Current (mA)	DC Resistance (ohm)	Q (min.)	Test Frequency (MHz)	Self Resonance Frequency (MHz)	EIA
LQG18HN15NJ00	15 ±5%	100	300	0.40 max.	12	100	2800 min.	0603
LQG18HN18NJ00	18 ±5%	100	300	0.45 max.	12	100	2600 min.	0603
LQG18HN22NJ00	22 ±5%	100	300	0.50 max.	12	100	2300 min.	0603
LQG18HN27NJ00	27 ±5%	100	300	0.55 max.	12	100	2000 min.	0603
LQG18HN33NJ00	33 ±5%	100	300	0.60 max.	12	100	1700 min.	0603
LQG18HN39NJ00	39 ±5%	100	300	0.65 max.	12	100	1500 min.	0603
LQG18HN47NJ00	47 ±5%	100	300	0.70 max.	12	100	1200 min.	0603
LQG18HN56NJ00	56 ±5%	100	300	0.75 max.	12	100	1100 min.	0603
LQG18HN68NJ00	68 ±5%	100	300	0.80 max.	12	100	1000 min.	0603
LQG18HN82NJ00	82 ±5%	100	300	0.85 max.	12	100	900 min.	0603
LQG18HNR10J00	100 ±5%	100	300	0.90 max.	12	100	800 min.	0603

Operating Temp. Range : -40°C to +85°C

■ Q-Frequency Characteristics

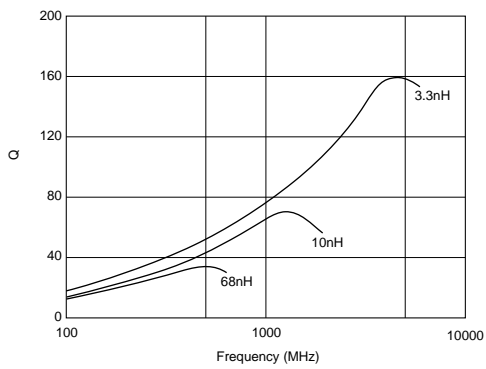

■ Inductance-Frequency Characteristics

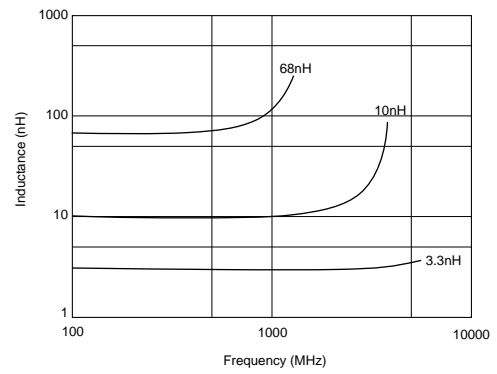

Chip Coils



High-frequency Film Type LQP03T/LQP15T/LQP15M/LQP18M Series

LQP03T Series

The LQP03T series consists of Ultra-Small chip coils with High Q value using Murata's original film technology.

■ Features

1. Ultra small size 0.6mmx0.3mm
2. Ultra-thin size
3. High Q value in high frequency band.
4. Lead is not contained in the products.

■ Applications

High frequency circuits of telecommunication equipments such as PDC, PCS, GSM and CDMA.

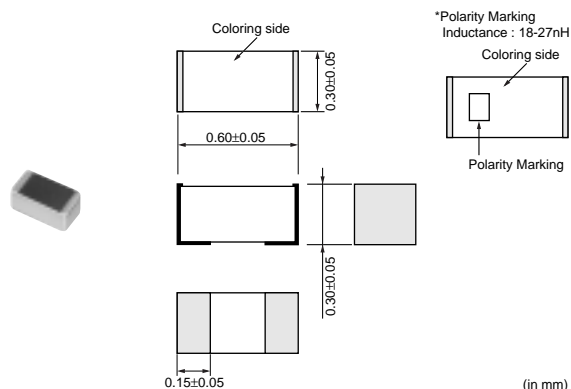

Part Number	Inductance (nH)	Test Frequency (MHz)	Rated Current (mA)	DC Resistance (ohm)	Q (min.)	Test Frequency (MHz)	Self Resonance Frequency (MHz)	EIA
LQP03TN0N6C00	0.6 ±0.2nH	500	420	0.08 max.	11	500	6000 min.	0201
LQP03TN0N8C00	0.8 ±0.2nH	500	410	0.09 max.	11	500	6000 min.	0201
LQP03TN1N0C00	1.0 ±0.2nH	500	400	0.10 max.	11	500	6000 min.	0201
LQP03TN1N2C00	1.2 ±0.2nH	500	280	0.13 max.	11	500	6000 min.	0201
LQP03TN1N5C00	1.5 ±0.2nH	500	280	0.16 max.	11	500	6000 min.	0201
LQP03TN1N8C00	1.8 ±0.2nH	500	280	0.16 max.	11	500	6000 min.	0201
LQP03TN2N2C00	2.2 ±0.2nH	500	220	0.18 max.	11	500	6000 min.	0201
LQP03TN2N7C00	2.7 ±0.2nH	500	220	0.21 max.	11	500	6000 min.	0201
LQP03TN3N3C00	3.3 ±0.2nH	500	190	0.30 max.	11	500	6000 min.	0201
LQP03TN3N9C00	3.9 ±0.2nH	500	170	0.45 max.	11	500	6000 min.	0201
LQP03TN4N7J00	4.7 ±5%	500	160	0.55 max.	11	500	6000 min.	0201
LQP03TN5N6J00	5.6 ±5%	500	140	0.68 max.	11	500	6000 min.	0201
LQP03TN6N8J00	6.8 ±5%	500	130	0.75 max.	11	500	6000 min.	0201
LQP03TN8N2J00	8.2 ±5%	500	110	0.86 max.	11	500	5500 min.	0201
LQP03TN10NJ00	10 ±5%	500	100	1.10 max.	11	500	4500 min.	0201
LQP03TN12NJ00	12 ±5%	500	90	1.25 max.	11	500	3700 min.	0201
LQP03TN15NJ00	15 ±5%	500	90	1.50 max.	11	500	3300 min.	0201
LQP03TN18NJ00	18 ±5%	500	80	2.0 max.	11	500	3100 min.	0201
LQP03TN22NJ00	22 ±5%	500	70	2.6 max.	11	500	2800 min.	0201
LQP03TN27NJ00	27 ±5%	500	70	3.1 max.	11	500	2500 min.	0201

Operating Temp. Range : -40°C to +85°C

■ Q-Frequency Characteristics

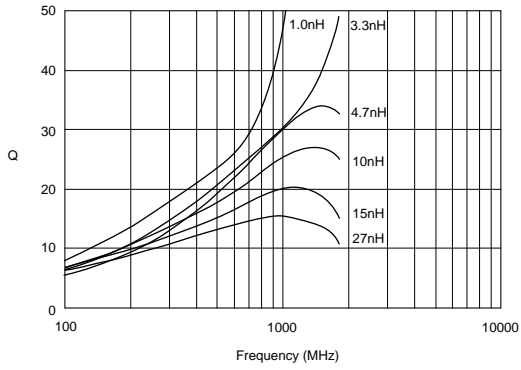

■ Inductance-Frequency Characteristics

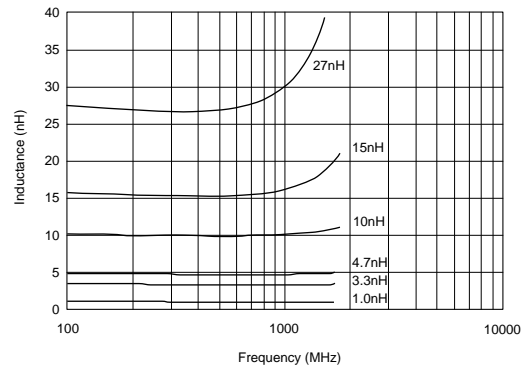

LQP15T Series

The LQP15T series offer High Q value, tight inductance tolerance with small/thin package using Murata's original film engineering technology.

■ Features

1. High Q value
2. Tight inductance tolerance(+0.2nH, +-3%)
3. Ultra small and tight size(1005size, Width 0.04mm)
4. Low DC resistance
5. Lead is no contained in the products.

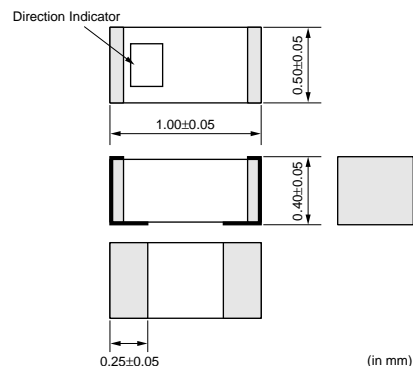

■ Applications

- High frequency circuits of Wirelesscommunication equipments.
- High frequency module such as PA, RF module for hand held phone.

Part Number	Inductance (nH)	Test Frequency (MHz)	Rated Current (mA)	DC Resistance (ohm)	Q (min.)	Test Frequency (MHz)	Self Resonance Frequency (MHz)	EIA
LQP15TN2N0C02	2.0 ±0.2nH	500	220	0.2 max.	17	500	6000 min.	0402
LQP15TN2N2C02	2.2 ±0.2nH	500	220	0.2 max.	17	500	6000 min.	0402
LQP15TN2N4C02	2.4 ±0.2nH	500	220	0.2 max.	17	500	6000 min.	0402
LQP15TN2N7C02	2.7 ±0.2nH	500	220	0.2 max.	17	500	6000 min.	0402
LQP15TN3N3C02	3.3 ±0.2nH	500	190	0.3 max.	17	500	5500 min.	0402
LQP15TN3N6C02	3.6 ±0.2nH	500	170	0.4 max.	17	500	5500 min.	0402
LQP15TN3N9C02	3.9 ±0.2nH	500	170	0.4 max.	17	500	5500 min.	0402
LQP15TN4N7C02	4.7 ±0.2nH	500	160	0.5 max.	17	500	5000 min.	0402
LQP15TN5N6C02	5.6 ±0.2nH	500	140	0.6 max.	17	500	4500 min.	0402
LQP15TN6N8H02	6.8 ±3%	500	130	0.7 max.	17	500	3500 min.	0402
LQP15TN8N2H02	8.2 ±3%	500	110	0.8 max.	17	500	3000 min.	0402
LQP15TN10NH02	10 ±3%	500	100	1.0 max.	17	500	2500 min.	0402
LQP15TN12NH02	12 ±3%	500	90	1.0 max.	17	500	2500 min.	0402
LQP15TN15NH02	15 ±3%	500	90	1.3 max.	17	500	2000 min.	0402
LQP15TN18NH02	18 ±3%	500	80	1.5 max.	17	500	1500 min.	0402

Operating Temp. Range : -40°C to +85°C

■ Q-Frequency Characteristics

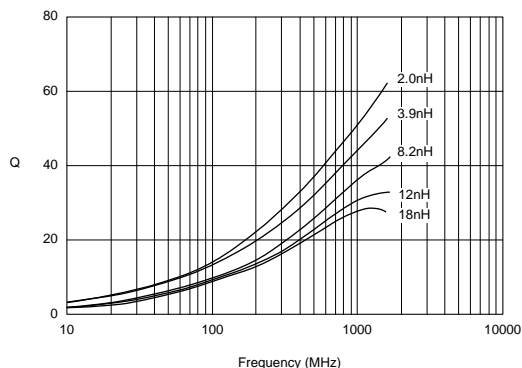

■ Inductance-Frequency Characteristics

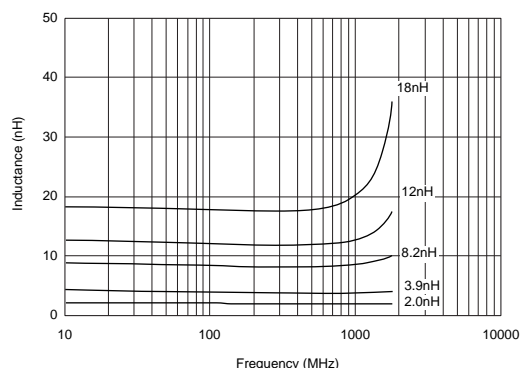

LQP15M Series

■ Features

1. Tight inductance tolerance (+-0.05nH, +-0.1nH, +-2%) realized by Murata's original film technology. Various inductance values enable to assemble with no tuning.
2. Ultra small size 0402 inductor which is low profile and lightest weight in the world enables to miniaturize mobile telecommunication equipment. Weight: LQP15M series 0.61mg/pcs. <-- --> Multilayer Type Inductor 0.94mg/pcs.
3. High Q at high frequency range.
4. High self resonant frequency due to low stray capacitance and close inductance distribution provide stable inductance in high frequency circuit such as telecommunication equipment.

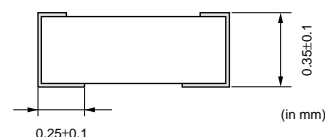
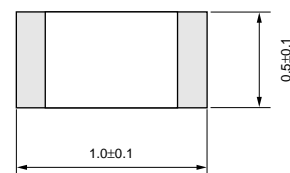

■ Applications

High frequency circuit of telecommunication equipment, such as DECT, PHS, PCS, PCN, GSM, DCS and CDMA.

Impedance Matching -- Power-AMP Module(PA)

SAW filter

Resonance circuits -- VCO

Part Number	Inductance (nH)	Test Frequency (MHz)	Rated Current (mA)	DC Resistance (ohm)	Q (min.)	Test Frequency (MHz)	Self Resonance Frequency (MHz)	EIA
LQP15MN1N0B02	1.0 ±0.1nH	500	400	0.1 max.	13	500	6000 min.	0402
LQP15MN1N0C02	1.0 ±0.2nH	500	400	0.1 max.	13	500	6000 min.	0402
LQP15MN1N0W02	1.0 ±0.05nH	500	400	0.1 max.	13	500	6000 min.	0402
LQP15MN1N1B02	1.1 ±0.1nH	500	390	0.1 max.	13	500	6000 min.	0402
LQP15MN1N1C02	1.1 ±0.2nH	500	390	0.1 max.	13	500	6000 min.	0402
LQP15MN1N1W02	1.1 ±0.05nH	500	390	0.1 max.	13	500	6000 min.	0402
LQP15MN1N2B02	1.2 ±0.1nH	500	390	0.1 max.	13	500	6000 min.	0402
LQP15MN1N2C02	1.2 ±0.2nH	500	390	0.1 max.	13	500	6000 min.	0402
LQP15MN1N2W02	1.2 ±0.05nH	500	390	0.1 max.	13	500	6000 min.	0402
LQP15MN1N3B02	1.3 ±0.1nH	500	280	0.2 max.	13	500	6000 min.	0402
LQP15MN1N3C02	1.3 ±0.2nH	500	280	0.2 max.	13	500	6000 min.	0402
LQP15MN1N3W02	1.3 ±0.05nH	500	280	0.2 max.	13	500	6000 min.	0402
LQP15MN1N4W02	1.4 ±0.05nH	500	280	0.2 max.	13	500	6000 min.	0402
LQP15MN1N5B02	1.5 ±0.1nH	500	280	0.2 max.	13	500	6000 min.	0402
LQP15MN1N5C02	1.5 ±0.2nH	500	280	0.2 max.	13	500	6000 min.	0402
LQP15MN1N5W02	1.5 ±0.05nH	500	280	0.2 max.	13	500	6000 min.	0402
LQP15MN1N6B02	1.6 ±0.1nH	500	220	0.3 max.	13	500	6000 min.	0402
LQP15MN1N6C02	1.6 ±0.2nH	500	220	0.3 max.	13	500	6000 min.	0402
LQP15MN1N6W02	1.6 ±0.05nH	500	220	0.3 max.	13	500	6000 min.	0402
LQP15MN1N7W02	1.7 ±0.05nH	500	280	0.2 max.	13	500	6000 min.	0402
LQP15MN1N8B02	1.8 ±0.1nH	500	280	0.2 max.	13	500	6000 min.	0402
LQP15MN1N8C02	1.8 ±0.2nH	500	280	0.2 max.	13	500	6000 min.	0402
LQP15MN1N8W02	1.8 ±0.05nH	500	280	0.2 max.	13	500	6000 min.	0402
LQP15MN1N9W02	1.9 ±0.05nH	500	220	0.3 max.	13	500	6000 min.	0402
LQP15MN2N0B02	2.0 ±0.1nH	500	220	0.3 max.	13	500	6000 min.	0402
LQP15MN2N0C02	2.0 ±0.2nH	500	220	0.3 max.	13	500	6000 min.	0402
LQP15MN2N0W02	2.0 ±0.05nH	500	220	0.3 max.	13	500	6000 min.	0402
LQP15MN2N1W02	2.1 ±0.05nH	500	220	0.3 max.	13	500	6000 min.	0402
LQP15MN2N2B02	2.2 ±0.1nH	500	220	0.3 max.	13	500	6000 min.	0402
LQP15MN2N2C02	2.2 ±0.2nH	500	220	0.3 max.	13	500	6000 min.	0402
LQP15MN2N2W02	2.2 ±0.05nH	500	220	0.3 max.	13	500	6000 min.	0402

Continued on the following page.

 Continued from the preceding page.

Part Number	Inductance (nH)	Test Frequency (MHz)	Rated Current (mA)	DC Resistance (ohm)	Q (min.)	Test Frequency (MHz)	Self Resonance Frequency (MHz)	EIA
LQP15MN2N3W02	2.3 ±0.05nH	500	220	0.3 max.	13	500	6000 min.	0402
LQP15MN2N4B02	2.4 ±0.1nH	500	220	0.3 max.	13	500	6000 min.	0402
LQP15MN2N4C02	2.4 ±0.2nH	500	220	0.3 max.	13	500	6000 min.	0402
LQP15MN2N4W02	2.4 ±0.05nH	500	220	0.3 max.	13	500	6000 min.	0402
LQP15MN2N5W02	2.5 ±0.05nH	500	220	0.3 max.	13	500	6000 min.	0402
LQP15MN2N6W02	2.6 ±0.05nH	500	220	0.3 max.	13	500	6000 min.	0402
LQP15MN2N7B02	2.7 ±0.1nH	500	220	0.3 max.	13	500	6000 min.	0402
LQP15MN2N7C02	2.7 ±0.2nH	500	220	0.3 max.	13	500	6000 min.	0402
LQP15MN2N7W02	2.7 ±0.05nH	500	220	0.3 max.	13	500	6000 min.	0402
LQP15MN2N8W02	2.8 ±0.05nH	500	190	0.4 max.	13	500	6000 min.	0402
LQP15MN2N9W02	2.9 ±0.05nH	500	190	0.4 max.	13	500	6000 min.	0402
LQP15MN3N0B02	3.0 ±0.1nH	500	190	0.4 max.	13	500	6000 min.	0402
LQP15MN3N0C02	3.0 ±0.2nH	500	190	0.4 max.	13	500	6000 min.	0402
LQP15MN3N0W02	3.0 ±0.05nH	500	190	0.4 max.	13	500	6000 min.	0402
LQP15MN3N1W02	3.1 ±0.05nH	500	190	0.4 max.	13	500	6000 min.	0402
LQP15MN3N2W02	3.2 ±0.05nH	500	190	0.4 max.	13	500	6000 min.	0402
LQP15MN3N3B02	3.3 ±0.1nH	500	190	0.4 max.	13	500	6000 min.	0402
LQP15MN3N3C02	3.3 ±0.2nH	500	190	0.4 max.	13	500	6000 min.	0402
LQP15MN3N3W02	3.3 ±0.05nH	500	190	0.4 max.	13	500	6000 min.	0402
LQP15MN3N4W02	3.4 ±0.05nH	500	170	0.5 max.	13	500	6000 min.	0402
LQP15MN3N5W02	3.5 ±0.05nH	500	170	0.5 max.	13	500	6000 min.	0402
LQP15MN3N6B02	3.6 ±0.1nH	500	170	0.5 max.	13	500	6000 min.	0402
LQP15MN3N6C02	3.6 ±0.2nH	500	170	0.5 max.	13	500	6000 min.	0402
LQP15MN3N6W02	3.6 ±0.05nH	500	170	0.5 max.	13	500	6000 min.	0402
LQP15MN3N7W02	3.7 ±0.05nH	500	170	0.5 max.	13	500	6000 min.	0402
LQP15MN3N8W02	3.8 ±0.05nH	500	170	0.5 max.	13	500	6000 min.	0402
LQP15MN3N9B02	3.9 ±0.1nH	500	170	0.5 max.	13	500	6000 min.	0402
LQP15MN3N9C02	3.9 ±0.2nH	500	170	0.5 max.	13	500	6000 min.	0402
LQP15MN3N9W02	3.9 ±0.05nH	500	170	0.5 max.	13	500	6000 min.	0402
LQP15MN4N3B02	4.3 ±0.1nH	500	160	0.6 max.	13	500	6000 min.	0402
LQP15MN4N3C02	4.3 ±0.2nH	500	160	0.6 max.	13	500	6000 min.	0402
LQP15MN4N7B02	4.7 ±0.1nH	500	160	0.6 max.	13	500	6000 min.	0402
LQP15MN4N7C02	4.7 ±0.2nH	500	160	0.6 max.	13	500	6000 min.	0402
LQP15MN5N1B02	5.1 ±0.1nH	500	140	0.7 max.	13	500	6000 min.	0402
LQP15MN5N1C02	5.1 ±0.2nH	500	140	0.7 max.	13	500	6000 min.	0402
LQP15MN5N6B02	5.6 ±0.1nH	500	140	0.7 max.	13	500	6000 min.	0402
LQP15MN5N6C02	5.6 ±0.2nH	500	140	0.7 max.	13	500	6000 min.	0402
LQP15MN6N2B02	6.2 ±0.1nH	500	130	0.9 max.	13	500	6000 min.	0402
LQP15MN6N2C02	6.2 ±0.2nH	500	130	0.9 max.	13	500	6000 min.	0402
LQP15MN6N8B02	6.8 ±0.1nH	500	130	0.9 max.	13	500	6000 min.	0402
LQP15MN6N8C02	6.8 ±0.2nH	500	130	0.9 max.	13	500	6000 min.	0402
LQP15MN7N5B02	7.5 ±0.1nH	500	110	1.1 max.	13	500	5500 min.	0402
LQP15MN7N5C02	7.5 ±0.2nH	500	110	1.1 max.	13	500	5500 min.	0402
LQP15MN8N2B02	8.2 ±0.1nH	500	110	1.1 max.	13	500	5500 min.	0402
LQP15MN8N2C02	8.2 ±0.2nH	500	110	1.1 max.	13	500	5500 min.	0402
LQP15MN9N1B02	9.1 ±0.1nH	500	100	1.3 max.	13	500	4500 min.	0402
LQP15MN9N1C02	9.1 ±0.2nH	500	100	1.3 max.	13	500	4500 min.	0402
LQP15MN10NG02	10 ±2%	500	100	1.3 max.	13	500	4500 min.	0402
LQP15MN10NJ02	10 ±5%	500	100	1.3 max.	13	500	4500 min.	0402
LQP15MN12NG02	12 ±2%	500	90	1.6 max.	13	500	3700 min.	0402
LQP15MN12NJ02	12 ±5%	500	90	1.6 max.	13	500	3700 min.	0402
LQP15MN15NG02	15 ±2%	500	90	1.8 max.	13	500	3300 min.	0402
LQP15MN15NJ02	15 ±5%	500	90	1.8 max.	13	500	3300 min.	0402
LQP15MN18NG02	18 ±2%	500	80	2.0 max.	13	500	3100 min.	0402
LQP15MN18NJ02	18 ±5%	500	80	2.0 max.	13	500	3100 min.	0402
LQP15MN22NG02	22 ±2%	500	70	2.6 max.	13	500	2800 min.	0402
LQP15MN22NJ02	22 ±5%	500	70	2.6 max.	13	500	2800 min.	0402

Continued on the following page. 

Continued from the preceding page.

Part Number	Inductance (nH)	Test Frequency (MHz)	Rated Current (mA)	DC Resistance (ohm)	Q (min.)	Test Frequency (MHz)	Self Resonance Frequency (MHz)	EIA
LQP15MN27NG02	27 ±2%	500	70	3.1 max.	13	500	2500 min.	0402
LQP15MN27NJ02	27 ±5%	500	70	3.1 max.	13	500	2500 min.	0402
LQP15MN33NG02	33 ±2%	500	60	3.8 max.	13	500	2100 min.	0402
LQP15MN33NJ02	33 ±5%	500	60	3.8 max.	13	500	2100 min.	0402

Operating Temp. Range : -40°C to +85°C

■ Q-Frequency Characteristics

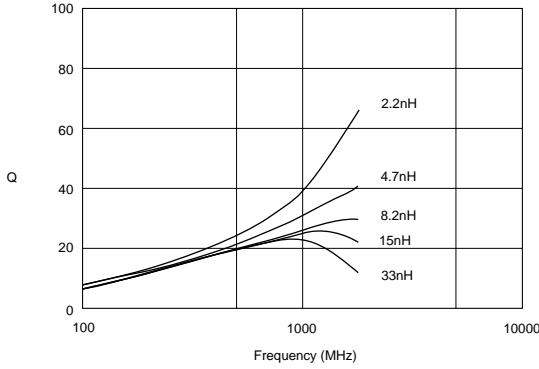

■ Inductance-Frequency Characteristics

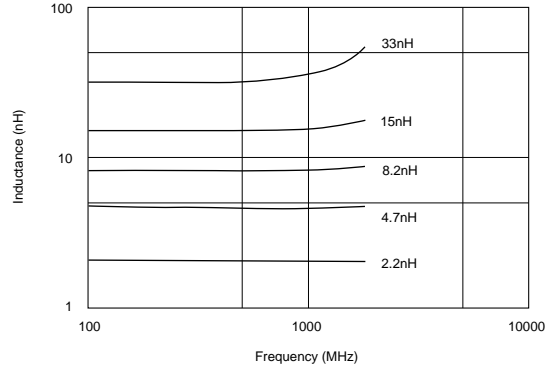

LQP18M Series

■ Features

1. Tight inductance tolerance (+-0.2nH, +-2%) realized by Murata's original film technology. Various inductance values enable to assemble with no tuning.
2. Small size of LQP18M series is suitable for small hand held equipment, especially for card size equipment.
3. High Q at high frequency range.
4. High self resonant frequency due to low stray capacitance and close inductance distribution provide stable inductance in high frequency circuit such as telecommunication equipment.

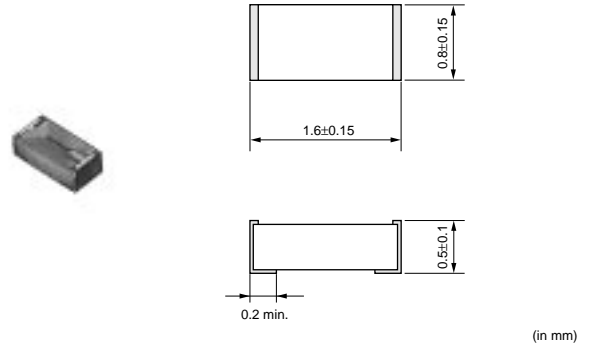

■ Applications

High frequency circuit of telecommunication equipment, such as DECT, PHS, PCS, PCN, GSM, DCS and CDMA.
 Impedance Matching -- Power-AMP Module(PA)
 SAW filter
 Resonance circuits -- VCO

Part Number	Inductance (nH)	Test Frequency (MHz)	Rated Current (mA)	DC Resistance (ohm)	Q (min.)	Test Frequency (MHz)	Self Resonance Frequency (MHz)	EIA
LQP18MN1N3C00	1.3 ±0.2nH	500	300	0.3 max.	17	500	6000 min.	0603
LQP18MN1N5C00	1.5 ±0.2nH	500	300	0.3 max.	17	500	6000 min.	0603
LQP18MN1N8C00	1.8 ±0.2nH	500	250	0.4 max.	17	500	6000 min.	0603
LQP18MN2N2C00	2.2 ±0.2nH	500	250	0.4 max.	17	500	6000 min.	0603
LQP18MN2N7C00	2.7 ±0.2nH	500	250	0.4 max.	17	500	6000 min.	0603
LQP18MN3N3C00	3.3 ±0.2nH	500	250	0.4 max.	17	500	6000 min.	0603
LQP18MN3N9C00	3.9 ±0.2nH	500	200	0.5 max.	17	500	5900 min.	0603
LQP18MN4N7C00	4.7 ±0.2nH	500	200	0.5 max.	17	500	5200 min.	0603
LQP18MN5N6C00	5.6 ±0.2nH	500	200	0.6 max.	17	500	4700 min.	0603
LQP18MN6N8C00	6.8 ±0.2nH	500	200	0.7 max.	17	500	4300 min.	0603
LQP18MN8N2C00	8.2 ±0.2nH	500	150	0.8 max.	17	500	3600 min.	0603

Continued on the following page. ↗

Continued from the preceding page.

Part Number	Inductance (nH)	Test Frequency (MHz)	Rated Current (mA)	DC Resistance (ohm)	Q (min.)	Test Frequency (MHz)	Self Resonance Frequency (MHz)	EIA
LQP18MN10NG00	10 ±2%	500	150	1.0 max.	17	500	3400 min.	0603
LQP18MN12NG00	12 ±2%	500	150	1.0 max.	17	500	3000 min.	0603
LQP18MN15NG00	15 ±2%	500	150	1.3 max.	17	500	2700 min.	0603
LQP18MN18NG00	18 ±2%	500	100	1.5 max.	17	500	2300 min.	0603
LQP18MN22NG00	22 ±2%	500	100	1.9 max.	17	500	2100 min.	0603
LQP18MN27NG00	27 ±2%	500	100	2.4 max.	17	500	1900 min.	0603
LQP18MN33NG00	33 ±2%	500	100	2.8 max.	17	500	1700 min.	0603
LQP18MN39NG00	39 ±2%	500	100	2.8 max.	17	500	1400 min.	0603
LQP18MN47NG00	47 ±2%	500	100	2.2 max.	17	300	1200 min.	0603
LQP18MN56NG00	56 ±2%	500	50	3.4 max.	17	300	1000 min.	0603
LQP18MN68NG00	68 ±2%	500	50	3.5 max.	17	300	900 min.	0603
LQP18MN82NG00	82 ±2%	500	50	4.6 max.	17	300	800 min.	0603
LQP18MNR10G00	100 ±2%	500	50	6.1 max.	17	300	700 min.	0603

Operating Temp. Range : -40°C to +85°C

■ Q-Frequency Characteristics

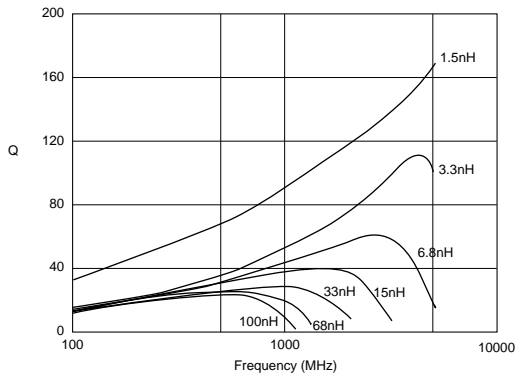

■ Inductance-Frequency Characteristics

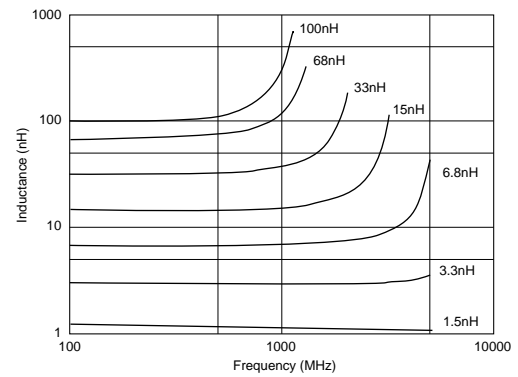

Chip Coils



High-frequency Winding Type LQW15A/LQW18A Series

LQW15A Series

3

The LQW15A series which consists of air core chip coil using a miniature alumina core.

The tight inductance tolerance ($\pm 0.2\text{nH}$, $\pm 3\%$) is available due to Murata's original winding technology. The LQW15A series has high Q value and high self resonant frequency in high frequency range. It is suitable for high frequency circuits which are used in telecommunication equipment.

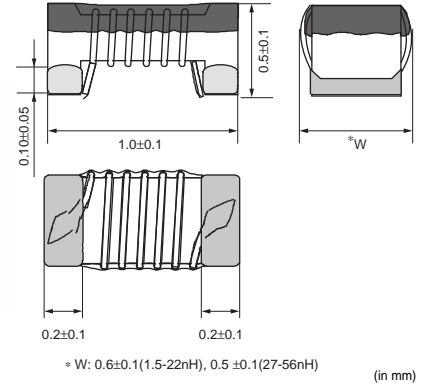

■ Features

1. Horizontal winding structure enables tight inductance tolerance ($\pm 0.2\text{nH}$, $\pm 3\%$)
2. The subminiature dimensions (1.0x0.5mm) allow high density mounting.
3. The high self resonant frequency realizes high-Q value and stable inductance at high frequency.
4. Low DC resistance design is ideal for low loss, high output and low power consumption.
5. Resin-coated surface enables excellent mounting.

■ Applications

High frequency circuits in telecommunication equipment, such as DECT, PHS, PCS, PCN, GSM and CDMA.
 Impedance Matching -- Power-AMP Module (PA)
 SAW filter
 Resonance circuits -- VCO

Part Number	Inductance (nH)	Test Frequency (MHz)	Rated Current (mA)	DC Resistance (ohm)	Q (min.)	Test Frequency (MHz)	Self Resonance Frequency (GHz)	EIA
LQW15AN1N5C00	1.5 $\pm 0.2\text{nH}$	100	1000	0.03 max.	10	250	18.0 min.	0402
LQW15AN1N5D00	1.5 $\pm 0.5\text{nH}$	100	1000	0.03 max.	10	250	18.0 min.	0402
LQW15AN2N7C00	2.7 $\pm 0.2\text{nH}$	100	850	0.05 max.	20	250	15.0 min.	0402
LQW15AN2N7D00	2.7 $\pm 0.5\text{nH}$	100	850	0.05 max.	20	250	15.0 min.	0402
LQW15AN3N9C00	3.9 $\pm 0.2\text{nH}$	100	750	0.07 max.	25	250	10 min.	0402
LQW15AN3N9D00	3.9 $\pm 0.5\text{nH}$	100	750	0.07 max.	25	250	10 min.	0402
LQW15AN4N3C00	4.3 $\pm 0.2\text{nH}$	100	750	0.07 max.	25	250	10.0 min.	0402
LQW15AN4N3D00	4.3 $\pm 0.5\text{nH}$	100	750	0.07 max.	25	250	10.0 min.	0402
LQW15AN4N7C00	4.7 $\pm 0.2\text{nH}$	100	750	0.07 max.	25	250	8.0 min.	0402
LQW15AN4N7D00	4.7 $\pm 0.5\text{nH}$	100	750	0.07 max.	25	250	8.0 min.	0402
LQW15AN5N1C00	5.1 $\pm 0.2\text{nH}$	100	600	0.12 max.	25	250	8.0 min.	0402
LQW15AN5N1D00	5.1 $\pm 0.5\text{nH}$	100	600	0.12 max.	25	250	8.0 min.	0402
LQW15AN6N2C00	6.2 $\pm 0.2\text{nH}$	100	700	0.09 max.	25	250	8.0 min.	0402
LQW15AN6N2D00	6.2 $\pm 0.5\text{nH}$	100	700	0.09 max.	25	250	8.0 min.	0402
LQW15AN6N8H00	6.8 $\pm 3\%$	100	700	0.09 max.	25	250	6.0 min.	0402
LQW15AN6N8J00	6.8 $\pm 5\%$	100	700	0.09 max.	25	250	6.0 min.	0402
LQW15AN7N5H00	7.5 $\pm 3\%$	100	570	0.13 max.	25	250	6.0 min.	0402
LQW15AN7N5J00	7.5 $\pm 5\%$	100	570	0.13 max.	25	250	6.0 min.	0402
LQW15AN8N2H00	8.2 $\pm 3\%$	100	540	0.14 max.	25	250	5.5 min.	0402
LQW15AN8N2J00	8.2 $\pm 5\%$	100	540	0.14 max.	25	250	5.5 min.	0402
LQW15AN9N1H00	9.1 $\pm 3\%$	100	540	0.14 max.	25	250	5.5 min.	0402

Continued on the following page.



Continued from the preceding page.

Part Number	Inductance (nH)	Test Frequency (MHz)	Rated Current (mA)	DC Resistance (ohm)	Q (min.)	Test Frequency (MHz)	Self Resonance Frequency (GHz)	EIA
LQW15AN9N1J00	9.1 ±5%	100	540	0.14 max.	25	250	5.5 min.	0402
LQW15AN10NH00	10 ±3%	100	500	0.17 max.	25	250	5.5 min.	0402
LQW15AN10NJ00	10 ±5%	100	500	0.17 max.	25	250	5.5 min.	0402
LQW15AN12NH00	12 ±3%	100	500	0.14 max.	30	250	5.5 min.	0402
LQW15AN12NJ00	12 ±5%	100	500	0.14 max.	30	250	5.5 min.	0402
LQW15AN15NH00	15 ±3%	100	460	0.16 max.	30	250	5.0 min.	0402
LQW15AN15NJ00	15 ±5%	100	460	0.16 max.	30	250	5.0 min.	0402
LQW15AN18NH00	18 ±3%	100	370	0.27 max.	25	250	4.5 min.	0402
LQW15AN18NJ00	18 ±5%	100	370	0.27 max.	25	250	4.5 min.	0402
LQW15AN22NH00	22 ±3%	100	310	0.30 max.	25	250	4.0 min.	0402
LQW15AN22NJ00	22 ±5%	100	310	0.30 max.	25	250	4.0 min.	0402
LQW15AN27NH00	27 ±3%	100	280	0.52 max.	25	250	3.5 min.	0402
LQW15AN27NJ00	27 ±5%	100	280	0.52 max.	25	250	3.5 min.	0402
LQW15AN33NH00	33 ±3%	100	260	0.63 max.	25	250	3.2 min.	0402
LQW15AN33NJ00	33 ±5%	100	260	0.63 max.	25	250	3.2 min.	0402
LQW15AN39NH00	39 ±3%	100	250	0.70 max.	25	250	3.0 min.	0402
LQW15AN39NJ00	39 ±5%	100	250	0.70 max.	25	250	3.0 min.	0402
LQW15AN47NH00	47 ±3%	100	210	1.08 max.	25	200	2.9 min.	0402
LQW15AN47NJ00	47 ±5%	100	210	1.08 max.	25	200	2.9 min.	0402
LQW15AN56NH00	56 ±3%	100	200	1.17 max.	25	200	2.8 min.	0402
LQW15AN56NJ00	56 ±5%	100	200	1.17 max.	25	200	2.8 min.	0402

Operating Temp. Range : -55°C to 125°C

Q-Frequency Characteristics

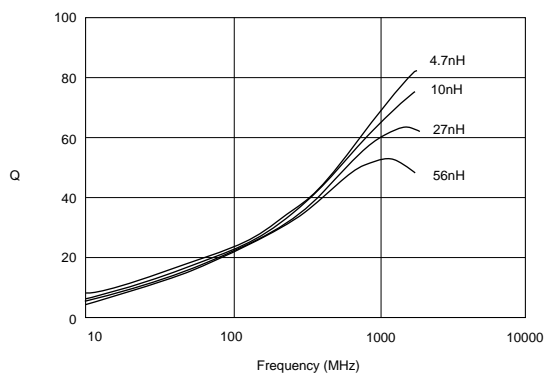

Inductance-Frequency Characteristics

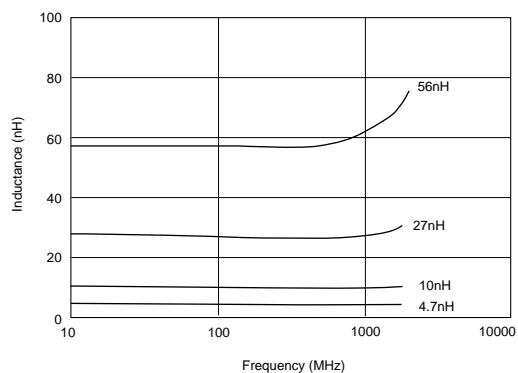

■ Features

LQW18A(Standard type)

1. Broad range of inductance(2.2nH to 470nH) with E24 step line up.
2. Horizontal winding structure enables tight inductance (+-0.2nH, +-2%). Stable circuit operation is possible.
3. The subminiature dimensions (1.6x0.8mm) allow high density mounting.
4. The high self resonant frequency realizes high-Q value and stable inductance at high frequency.
5. Low DC resistance design is ideal for low loss, high output and low power consumption.
6. Resin-coated surface enables excellent mounting.

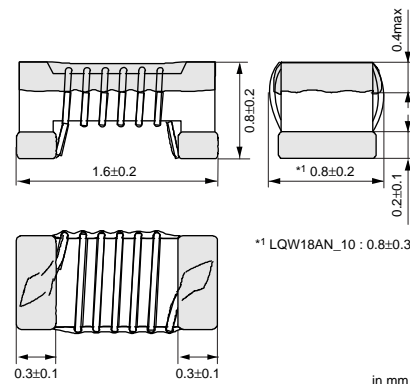
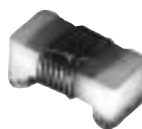

■ Applications

High frequency circuit in telecommunication equipment, such as DECT, PHS, PCS, GSM and CDMA.

Impedance Matching -- Power-AMP Module(PA)

SAW filter

Resonance circuits -- VCO

■ Features

LQW18A_10(High-Q/Low DC Resistance type)

Lower DC Resistance approximately by 50% than current type. Higher Q by 10%, Higher rated current by 20%.

■ Applications

Cellular phone and Base station.

W-CDMA, GSM, N-CDMA, PDC.

Higher Q -- Matching circuit for antenna, SAWFIL.

Lower Rdc -- Choke coil for IF, RF circuit like PA.

Equipment with high frequency circuits (Wireless LAN etc.)

LQW18A_00 Series

Part Number	Inductance (nH)	Test Frequency (MHz)	Rated Current (mA)	DC Resistance (ohm)	Q (min.)	Test Frequency (MHz)	Self Resonance Frequency (MHz)	EIA
LQW18AN2N2D00	2.2 ±0.5nH	100	700	0.049 max.	16	250	6000 min.	0603
LQW18AN3N6C00	3.6 ±0.2nH	100	850	0.059 max.	25	250	6000 min.	0603
LQW18AN3N6D00	3.6 ±0.5nH	100	850	0.059 max.	25	250	6000 min.	0603
LQW18AN3N9C00	3.9 ±0.2nH	100	850	0.059 max.	35	250	6000 min.	0603
LQW18AN3N9D00	3.9 ±0.5nH	100	850	0.059 max.	35	250	6000 min.	0603
LQW18AN4N3C00	4.3 ±0.2nH	100	850	0.059 max.	35	250	6000 min.	0603
LQW18AN4N3D00	4.3 ±0.5nH	100	850	0.059 max.	35	250	6000 min.	0603
LQW18AN4N7D00	4.7 ±0.5nH	100	850	0.059 max.	35	250	6000 min.	0603
LQW18AN5N6C00	5.6 ±0.2nH	100	750	0.082 max.	35	250	6000 min.	0603
LQW18AN5N6D00	5.6 ±0.5nH	100	750	0.082 max.	35	250	6000 min.	0603
LQW18AN6N2C00	6.2 ±0.2nH	100	750	0.082 max.	35	250	6000 min.	0603
LQW18AN6N2D00	6.2 ±0.5nH	100	750	0.082 max.	35	250	6000 min.	0603
LQW18AN6N8C00	6.8 ±0.2nH	100	750	0.082 max.	35	250	6000 min.	0603
LQW18AN6N8D00	6.8 ±0.5nH	100	750	0.082 max.	35	250	6000 min.	0603
LQW18AN7N5D00	7.5 ±0.5nH	100	750	0.082 max.	35	250	6000 min.	0603
LQW18AN8N2D00	8.2 ±0.5nH	100	650	0.11 max.	35	250	6000 min.	0603
LQW18AN8N7D00	8.7 ±0.5nH	100	650	0.11 max.	35	250	6000 min.	0603
LQW18AN9N1D00	9.1 ±0.5nH	100	650	0.11 max.	35	250	6000 min.	0603
LQW18AN9N5D00	9.5 ±0.5nH	100	650	0.11 max.	35	250	6000 min.	0603
LQW18AN10NG00	10 ±2%	100	650	0.11 max.	35	250	6000 min.	0603

Continued on the following page.

 Continued from the preceding page.

Part Number	Inductance (nH)	Test Frequency (MHz)	Rated Current (mA)	DC Resistance (ohm)	Q (min.)	Test Frequency (MHz)	Self Resonance Frequency (MHz)	EIA
LQW18AN10NJ00	10 ±5%	100	650	0.11 max.	35	250	6000 min.	0603
LQW18AN11NG00	11 ±2%	100	650	0.11 max.	35	250	6000 min.	0603
LQW18AN11NJ00	11 ±5%	100	650	0.11 max.	35	250	6000 min.	0603
LQW18AN12NG00	12 ±2%	100	600	0.13 max.	35	250	6000 min.	0603
LQW18AN12NJ00	12 ±5%	100	600	0.13 max.	35	250	6000 min.	0603
LQW18AN13NG00	13 ±2%	100	600	0.13 max.	35	250	6000 min.	0603
LQW18AN13NJ00	13 ±5%	100	600	0.13 max.	35	250	6000 min.	0603
LQW18AN15NG00	15 ±2%	100	600	0.13 max.	40	250	6000 min.	0603
LQW18AN15NJ00	15 ±5%	100	600	0.13 max.	40	250	6000 min.	0603
LQW18AN16NG00	16 ±2%	100	550	0.16 max.	40	250	5500 min.	0603
LQW18AN16NJ00	16 ±5%	100	550	0.16 max.	40	250	5500 min.	0603
LQW18AN18NG00	18 ±2%	100	550	0.16 max.	40	250	5500 min.	0603
LQW18AN18NJ00	18 ±5%	100	550	0.16 max.	40	250	5500 min.	0603
LQW18AN20NG00	20 ±2%	100	550	0.16 max.	40	250	4900 min.	0603
LQW18AN20NJ00	20 ±5%	100	550	0.16 max.	40	250	4900 min.	0603
LQW18AN22NG00	22 ±2%	100	500	0.17 max.	40	250	4600 min.	0603
LQW18AN22NJ00	22 ±5%	100	500	0.17 max.	40	250	4600 min.	0603
LQW18AN24NG00	24 ±2%	100	500	0.21 max.	40	250	3800 min.	0603
LQW18AN24NJ00	24 ±5%	100	500	0.21 max.	40	250	3800 min.	0603
LQW18AN27NG00	27 ±2%	100	440	0.21 max.	40	250	3700 min.	0603
LQW18AN27NJ00	27 ±5%	100	440	0.21 max.	40	250	3700 min.	0603
LQW18AN30NG00	30 ±2%	100	420	0.23 max.	40	250	3300 min.	0603
LQW18AN30NJ00	30 ±5%	100	420	0.23 max.	40	250	3300 min.	0603
LQW18AN33NG00	33 ±2%	100	420	0.23 max.	40	250	3200 min.	0603
LQW18AN33NJ00	33 ±5%	100	420	0.23 max.	40	250	3200 min.	0603
LQW18AN36NG00	36 ±2%	100	400	0.26 max.	40	250	2900 min.	0603
LQW18AN36NJ00	36 ±5%	100	400	0.26 max.	40	250	2900 min.	0603
LQW18AN39NG00	39 ±2%	100	400	0.26 max.	40	250	2800 min.	0603
LQW18AN39NJ00	39 ±5%	100	400	0.26 max.	40	250	2800 min.	0603
LQW18AN43NG00	43 ±2%	100	380	0.29 max.	40	200	2700 min.	0603
LQW18AN43NJ00	43 ±5%	100	380	0.29 max.	40	200	2700 min.	0603
LQW18AN47NG00	47 ±2%	100	380	0.29 max.	38	200	2600 min.	0603
LQW18AN47NJ00	47 ±5%	100	380	0.29 max.	38	200	2600 min.	0603
LQW18AN51NG00	51 ±2%	100	370	0.33 max.	38	200	2500 min.	0603
LQW18AN51NJ00	51 ±5%	100	370	0.33 max.	38	200	2500 min.	0603
LQW18AN56NG00	56 ±2%	100	360	0.35 max.	38	200	2400 min.	0603
LQW18AN56NJ00	56 ±5%	100	360	0.35 max.	38	200	2400 min.	0603
LQW18AN62NG00	62 ±2%	100	280	0.51 max.	38	200	2300 min.	0603
LQW18AN62NJ00	62 ±5%	100	280	0.51 max.	38	200	2300 min.	0603
LQW18AN68NG00	68 ±2%	100	340	0.38 max.	38	200	2200 min.	0603
LQW18AN68NJ00	68 ±5%	100	340	0.38 max.	38	200	2200 min.	0603
LQW18AN72NG00	72 ±2%	100	270	0.56 max.	34	150	2100 min.	0603
LQW18AN72NJ00	72 ±5%	100	270	0.56 max.	34	150	2100 min.	0603
LQW18AN75NG00	75 ±2%	100	270	0.56 max.	34	150	2050 min.	0603
LQW18AN75NJ00	75 ±5%	100	270	0.56 max.	34	150	2050 min.	0603
LQW18AN82NG00	82 ±2%	100	250	0.60 max.	34	150	2000 min.	0603
LQW18AN82NJ00	82 ±5%	100	250	0.60 max.	34	150	2000 min.	0603
LQW18AN91NG00	91 ±2%	100	230	0.64 max.	34	150	1900 min.	0603
LQW18AN91NJ00	91 ±5%	100	230	0.64 max.	34	150	1900 min.	0603
LQW18ANR10G00	100 ±2%	100	220	0.68 max.	34	150	1800 min.	0603
LQW18ANR10J00	100 ±5%	100	220	0.68 max.	34	150	1800 min.	0603
LQW18ANR11G00	110 ±2%	100	200	1.2 max.	32	150	1350 min.	0603
LQW18ANR11J00	110 ±5%	100	200	1.2 max.	32	150	1350 min.	0603
LQW18ANR12G00	120 ±2%	100	180	1.3 max.	32	150	1600 min.	0603
LQW18ANR12J00	120 ±5%	100	180	1.3 max.	32	150	1600 min.	0603
LQW18ANR13G00	130 ±2%	100	170	1.4 max.	32	150	1450 min.	0603
LQW18ANR13J00	130 ±5%	100	170	1.4 max.	32	150	1450 min.	0603

Continued on the following page. 

Continued from the preceding page.

Part Number	Inductance (nH)	Test Frequency (MHz)	Rated Current (mA)	DC Resistance (ohm)	Q (min.)	Test Frequency (MHz)	Self Resonance Frequency (MHz)	EIA
LQW18ANR15G00	150 ±2%	100	160	1.5 max.	32	150	1400 min.	0603
LQW18ANR15J00	150 ±5%	100	160	1.5 max.	32	150	1400 min.	0603
LQW18ANR16G00	160 ±2%	100	150	2.1 max.	32	150	1350 min.	0603
LQW18ANR16J00	160 ±5%	100	150	2.1 max.	32	150	1350 min.	0603
LQW18ANR18G00	180 ±2%	100	140	2.2 max.	25	100	1300 min.	0603
LQW18ANR18J00	180 ±5%	100	140	2.2 max.	25	100	1300 min.	0603
LQW18ANR20G00	200 ±2%	100	120	2.4 max.	25	100	1250 min.	0603
LQW18ANR20J00	200 ±5%	100	120	2.4 max.	25	100	1250 min.	0603
LQW18ANR22G00	220 ±2%	100	120	2.5 max.	25	100	1200 min.	0603
LQW18ANR22J00	220 ±5%	100	120	2.5 max.	25	100	1200 min.	0603
LQW18ANR27G00	270 ±2%	100	110	3.4 max.	30	100	960 min.	0603
LQW18ANR27J00	270 ±5%	100	110	3.4 max.	30	100	960 min.	0603
LQW18ANR33G00	330 ±2%	100	85	5.5 max.	30	100	800 min.	0603
LQW18ANR33J00	330 ±5%	100	85	5.5 max.	30	100	800 min.	0603
LQW18ANR39G00	390 ±2%	100	80	6.2 max.	30	100	800 min.	0603
LQW18ANR39J00	390 ±5%	100	80	6.2 max.	30	100	800 min.	0603
LQW18ANR47G00	470 ±2%	100	75	7.0 max.	30	100	700 min.	0603
LQW18ANR47J00	470 ±5%	100	75	7.0 max.	30	100	700 min.	0603

Operating Temp. Range : -25°C to 85°C

LQW18A_10 Series (High-Q/Low DC Resistance Type)

Part Number	Inductance (nH)	Test Frequency (MHz)	Rated Current (mA)	DC Resistance (ohm)	Q (min.)	Test Frequency (MHz)	Self Resonance Frequency (MHz)	EIA
LQW18AN2N2D10	2.2 ±0.5nH	100	1400	0.018 max.	25	250	18000 min.	0603
LQW18AN3N9C10	3.9 ±0.2nH	100	1000	0.032 max.	38	250	11000 min.	0603
LQW18AN3N9D10	3.9 ±0.5nH	100	1000	0.032 max.	38	250	11000 min.	0603
LQW18AN5N6D10	5.6 ±0.5nH	100	900	0.045 max.	38	250	10000 min.	0603
LQW18AN6N8C10	6.8 ±0.2nH	100	900	0.045 max.	38	250	7000 min.	0603
LQW18AN6N8D10	6.8 ±0.5nH	100	900	0.045 max.	38	250	7000 min.	0603
LQW18AN8N2D10	8.2 ±0.5nH	100	800	0.058 max.	38	250	7000 min.	0603
LQW18AN10NG10	10 ±2%	100	800	0.058 max.	38	250	5000 min.	0603
LQW18AN10NJ10	10 ±5%	100	800	0.058 max.	38	250	5000 min.	0603
LQW18AN12NG10	12 ±2%	100	750	0.071 max.	38	250	5000 min.	0603
LQW18AN12NJ10	12 ±5%	100	750	0.071 max.	38	250	5000 min.	0603
LQW18AN15NJ10	15 ±5%	100	700	0.085 max.	42	250	4500 min.	0603
LQW18AN18NG10	18 ±2%	100	700	0.085 max.	42	250	3500 min.	0603
LQW18AN18NJ10	18 ±5%	100	700	0.085 max.	42	250	3500 min.	0603
LQW18AN22NG10	22 ±2%	100	640	0.099 max.	42	250	3200 min.	0603
LQW18AN22NJ10	22 ±5%	100	640	0.099 max.	42	250	3200 min.	0603
LQW18AN27NG10	27 ±2%	100	590	0.116 max.	42	250	2800 min.	0603
LQW18AN27NJ10	27 ±5%	100	590	0.116 max.	42	250	2800 min.	0603
LQW18AN33NJ10	33 ±5%	100	550	0.132 max.	42	250	2500 min.	0603

Operating Temp. Range : -25°C to 85°C

■ Q-Frequency Characteristics

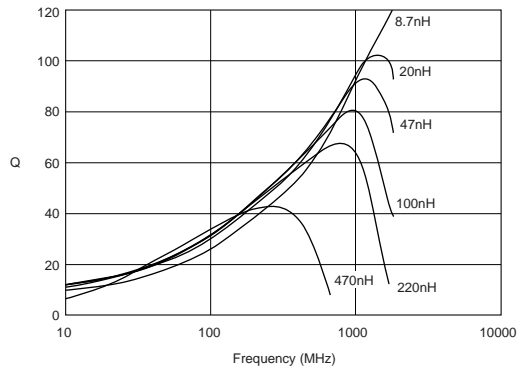

■ Inductance-Frequency Characteristics

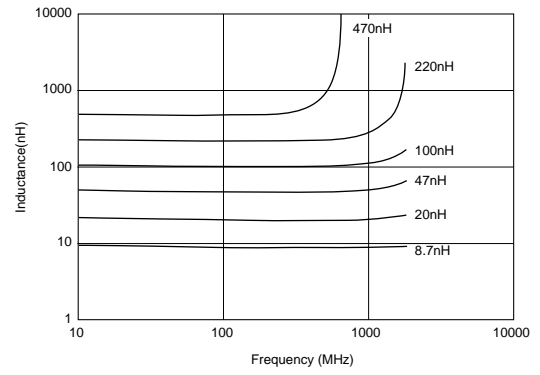

Chip Coils



High-frequency Winding Type LQW2BH/LQW31H Series

The LQW2BH series consists of air-core chip coil using a sub-miniature alumina core as a bobbin. The high Q value at high frequencies and high self-resonant frequencies make this coil perfect for use in the high frequency circuits of communications equipment.

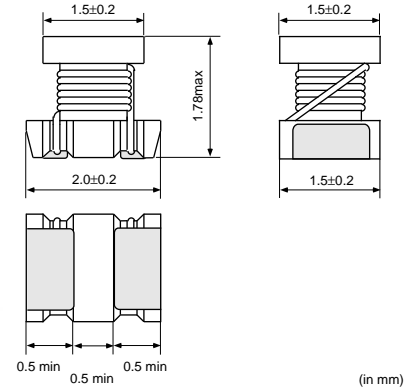

4

■ Features

1. LQW2BH series covers inductance range from 3.3nH to 470nH.
2. Their high self-resonant frequency characteristic yields a high Q value and highly stable inductance at high frequencies.
3. Low DC resistance design enables to handle higher allowable current.
4. The series has excellent solder heat resistance. Both flow and reflow soldering methods can be employed.

• LQW2BHN_J01, K01

Inductance tolerance $\pm 0.5\text{nH}$ (8.2nH max.), $\pm 5\%$ (10nH to 470nH) is realized. The sub miniature dimensions (2.0x1.5mm) allow high density mounting.

• LQW2BHN_G01 (Tight inductance tolerance)

Tight inductance tolerance of $\pm 2\%$ is available.

• LQW2BHN_11

LQW2BHN_11 using thick wire (0.12mm in diameter) has higher Q value than existing LQW2BH series. Low DC resistance design enables to handle higher current.

LQW2BHN_11 covers inductance range from 2.7nH to 27nH.

■ Applications

High frequency circuit in telecommunication equipment, such as DECT, PHS, PCS, PCN, GSM and CDMA.

Impedance Matching -- Power-AMP Module (PA)

SAW filter

Resonance circuits -- VCO

LQW2BH_01

Part Number	Inductance (nH)	Test Frequency (MHz)	Rated Current (mA)	DC Resistance (ohm)	Q (min.)	Test Frequency (MHz)	Self Resonance Frequency (MHz)	EIA
LQW2BHN8N2D01	8.2 $\pm 0.5\text{nH}$	100	630	0.12 max.	20	250	3900 min.	0805
LQW2BHN10NJ01	10 $\pm 5\%$	100	1320	0.03 max.	30	250	3300 min.	0805
LQW2BHN12NJ01	12 $\pm 5\%$	100	680	0.11 max.	30	250	3200 min.	0805
LQW2BHN15NJ01	15 $\pm 5\%$	100	630	0.12 max.	30	250	2700 min.	0805
LQW2BHN18NJ01	18 $\pm 5\%$	100	690	0.10 max.	30	250	2600 min.	0805
LQW2BHN22NJ01	22 $\pm 5\%$	100	720	0.09 max.	30	250	2100 min.	0805
LQW2BHN27NJ01	27 $\pm 5\%$	100	540	0.17 max.	40	250	2300 min.	0805
LQW2BHN33NG01	33 $\pm 2\%$	100	570	0.15 max.	40	250	1900 min.	0805
LQW2BHN33NJ01	33 $\pm 5\%$	100	570	0.15 max.	40	250	1900 min.	0805
LQW2BHN33NK01	33 $\pm 10\%$	100	570	0.15 max.	40	250	1900 min.	0805

Continued on the following page.

Continued from the preceding page.

Part Number	Inductance (nH)	Test Frequency (MHz)	Rated Current (mA)	DC Resistance (ohm)	Q (min.)	Test Frequency (MHz)	Self Resonance Frequency (MHz)	EIA
LQW2BHN39NG01	39 ±2%	100	730	0.09 max.	40	250	1700 min.	0805
LQW2BHN39NJ01	39 ±5%	100	730	0.09 max.	40	250	1700 min.	0805
LQW2BHN39NK01	39 ±10%	100	730	0.09 max.	40	250	1700 min.	0805
LQW2BHN47NG01	47 ±2%	100	450	0.23 max.	40	200	1600 min.	0805
LQW2BHN47NJ01	47 ±5%	100	450	0.23 max.	40	200	1600 min.	0805
LQW2BHN47NK01	47 ±10%	100	450	0.23 max.	40	200	1600 min.	0805
LQW2BHN56NG01	56 ±2%	100	430	0.26 max.	40	200	1500 min.	0805
LQW2BHN56NJ01	56 ±5%	100	430	0.26 max.	40	200	1500 min.	0805
LQW2BHN56NK01	56 ±10%	100	430	0.26 max.	40	200	1500 min.	0805
LQW2BHN68NG01	68 ±2%	100	460	0.23 max.	40	200	1200 min.	0805
LQW2BHN68NJ01	68 ±5%	100	460	0.23 max.	40	200	1200 min.	0805
LQW2BHN68NK01	68 ±10%	100	460	0.23 max.	40	200	1200 min.	0805
LQW2BHN82NG01	82 ±2%	100	320	0.42 max.	40	150	1100 min.	0805
LQW2BHN82NJ01	82 ±5%	100	320	0.42 max.	40	150	1100 min.	0805
LQW2BHN82NK01	82 ±10%	100	320	0.42 max.	40	150	1100 min.	0805
LQW2BHNR10G01	100 ±2%	100	270	0.55 max.	35	150	900 min.	0805
LQW2BHNR10J01	100 ±5%	100	350	0.38 max.	40	150	900 min.	0805
LQW2BHNR10K01	100 ±10%	100	350	0.38 max.	40	150	900 min.	0805
LQW2BHNR12G01	120 ±2%	100	320	0.40 max.	40	150	750 min.	0805
LQW2BHNR12J01	120 ±5%	100	320	0.40 max.	40	150	750 min.	0805
LQW2BHNR12K01	120 ±10%	100	320	0.40 max.	40	150	750 min.	0805
LQW2BHNR15G01	150 ±2%	100	260	0.68 max.	30	150	350 min.	0805
LQW2BHNR15J01	150 ±5%	100	390	0.47 max.	30	150	350 min.	0805
LQW2BHNR15K01	150 ±10%	100	390	0.47 max.	30	150	350 min.	0805
LQW2BHNR18G01	180 ±2%	100	250	0.71 max.	35	100	700 min.	0805
LQW2BHNR18J01	180 ±5%	100	250	0.71 max.	35	100	700 min.	0805
LQW2BHNR18K01	180 ±10%	100	250	0.71 max.	35	100	700 min.	0805
LQW2BHNR22G01	220 ±2%	100	240	0.70 max.	35	100	500 min.	0805
LQW2BHNR22J01	220 ±5%	100	240	0.70 max.	35	100	500 min.	0805
LQW2BHNR22K01	220 ±10%	100	240	0.70 max.	35	100	500 min.	0805
LQW2BHNR27K01	270 ±10%	100	190	2.00 max.	15	25.2	550 min.	0805
LQW2BHNR33K01	330 ±10%	100	180	2.20 max.	15	25.2	500 min.	0805
LQW2BHNR39K01	390 ±10%	100	170	2.50 max.	15	25.2	400 min.	0805
LQW2BHNR47K01	470 ±10%	100	160	2.80 max.	15	25.2	350 min.	0805

Operating Temp. Range : -25°C to 85°C

LQW2BH_11 (High-Q/Low DC Resistance Type)

Part Number	Inductance (nH)	Test Frequency (MHz)	Rated Current (mA)	DC Resistance (ohm)	Q (min.)	Test Frequency (MHz)	Self Resonance Frequency (MHz)	EIA
LQW2BHN2N7D11	2.7 ±0.5nH	100	1900	0.02 max.	20	250	6000 min.	0805
LQW2BHN3N1D11	3.1 ±0.5nH	100	1800	0.02 max.	20	250	6000 min.	0805
LQW2BHN3N3D11	3.3 ±0.5nH	100	1700	0.02 max.	20	250	6000 min.	0805
LQW2BHN5N6D11	5.6 ±0.5nH	100	1500	0.02 max.	35	250	6000 min.	0805
LQW2BHN6N8D11	6.8 ±0.5nH	100	1400	0.02 max.	35	250	5400 min.	0805
LQW2BHN8N6D11	8.6 ±0.5nH	100	1300	0.03 max.	35	250	3900 min.	0805
LQW2BHN10NJ11	10 ±5%	100	1320	0.03 max.	35	250	3300 min.	0805
LQW2BHN12NK11	12 ±10%	100	1100	0.04 max.	40	250	3200 min.	0805
LQW2BHN15NK11	15 ±10%	100	1000	0.04 max.	40	250	3100 min.	0805
LQW2BHN18NK11	18.8 ±10%	100	1000	0.05 max.	40	250	2600 min.	0805
LQW2BHN21NK11	21 ±10%	100	950	0.05 max.	40	250	2200 min.	0805
LQW2BHN27NK11	27 ±10%	100	900	0.06 max.	40	250	1800 min.	0805

Operating Temp. Range : -25°C to 85°C

■ Q-Frequency Characteristics

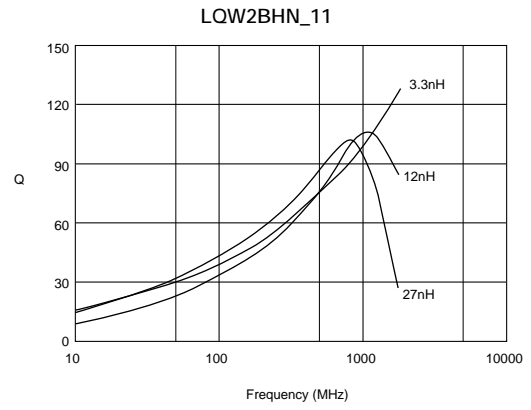
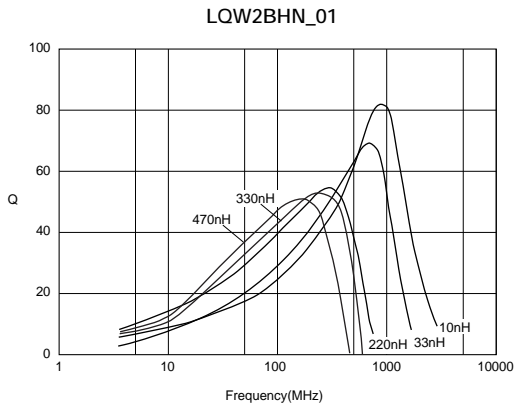

4

■ Inductance-Frequency Characteristics

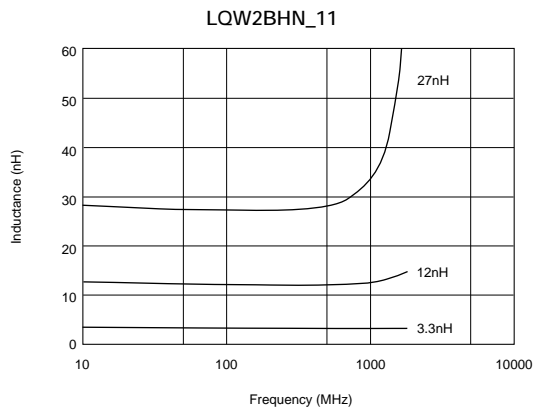

LQW31H Series

■ Features

The LQW31H series is alumina-core-type chip inductor for high frequency circuit. Its low dc resistance and high Q due to wound structure are suitable for hand telecommunication equipment.

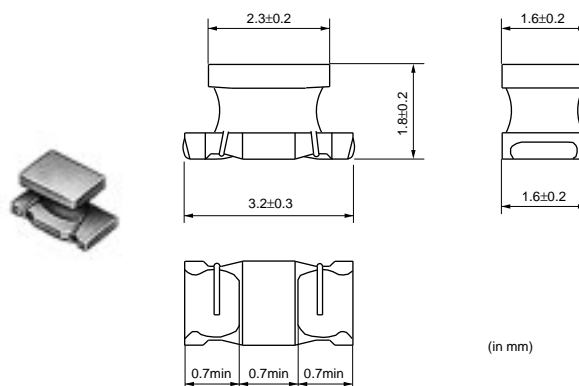

(in mm)

4

Part Number	Inductance (nH)	Test Frequency (MHz)	Rated Current (mA)	DC Resistance (ohm)	Q (min.)	Test Frequency (MHz)	Self Resonance Frequency (MHz)	EIA
LQW31HN8N8J01	8.8 ±5%	100	750	0.029 ±40%	50	436	1000 min.	1206
LQW31HN8N8K01	8.8 ±10%	100	750	0.029 ±40%	50	436	1000 min.	1206
LQW31HN15NJ01	14.7 ±5%	100	680	0.035 ±40%	60	436	1000 min.	1206
LQW31HN15NK01	14.7 ±10%	100	680	0.035 ±40%	60	436	1000 min.	1206
LQW31HN17NJ01	17 ±5%	100	650	0.037 ±40%	60	436	1000 min.	1206
LQW31HN17NK01	17 ±10%	100	650	0.037 ±40%	60	436	1000 min.	1206
LQW31HN23NJ01	23 ±5%	100	590	0.046 ±40%	60	436	1000 min.	1206
LQW31HN23NK01	23 ±10%	100	590	0.046 ±40%	60	436	1000 min.	1206
LQW31HN27NJ01	27 ±5%	100	560	0.051 ±40%	60	436	1000 min.	1206
LQW31HN27NK01	27 ±10%	100	560	0.051 ±40%	60	436	1000 min.	1206
LQW31HN33NJ01	33 ±5%	100	530	0.057 ±40%	60	436	1000 min.	1206
LQW31HN33NK01	33 ±10%	100	530	0.057 ±40%	60	436	1000 min.	1206
LQW31HN39NJ01	39 ±5%	100	490	0.067 ±40%	60	436	1000 min.	1206
LQW31HN39NK01	39 ±10%	100	490	0.067 ±40%	60	436	1000 min.	1206
LQW31HN47NJ01	47 ±5%	100	380	0.11 ±40%	60	436	1000 min.	1206
LQW31HN47NK01	47 ±10%	100	380	0.11 ±40%	60	436	1000 min.	1206
LQW31HN56NJ01	56 ±5%	100	330	0.14 ±40%	60	436	1000 min.	1206
LQW31HN56NK01	56 ±10%	100	330	0.14 ±40%	60	436	1000 min.	1206
LQW31HN64NJ01	64 ±5%	100	290	0.18 ±40%	60	436	1000 min.	1206
LQW31HN64NK01	64 ±10%	100	290	0.18 ±40%	60	436	1000 min.	1206
LQW31HN84NJ01	84 ±5%	100	240	0.28 ±40%	60	436	1000 min.	1206
LQW31HN84NK01	84 ±10%	100	240	0.28 ±40%	60	436	1000 min.	1206
LQW31HNR10J01	100 ±5%	100	230	0.3 ±40%	60	436	900 min.	1206
LQW31HNR10K01	100 ±10%	100	230	0.3 ±40%	60	436	900 min.	1206

Operating Temp. Range : -25°C to 85°C

■ Q-Frequency Characteristics

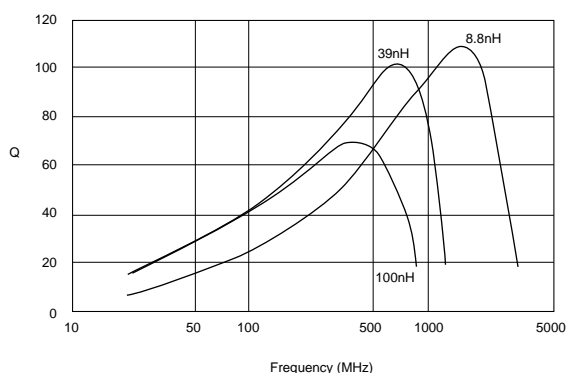

Chip Coils



High-frequency Winding Type LQH31H Series

■ Features

The LQH31H series is wound type chip inductor with ferrite core. Its high Q values from 30MHz to 150MHz and low DC resistance are suitable in high frequency resonator.

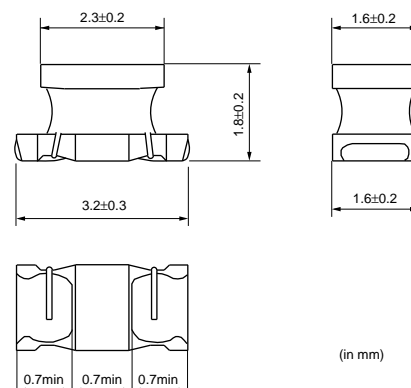

5

Part Number	Inductance (nH)	Test Frequency (MHz)	Rated Current (mA)	DC Resistance (ohm)	Q (min.)	Test Frequency (MHz)	Self Resonance Frequency (MHz)	EIA
LQH31HN54NK01	54 ±10%	1	920	0.035 ±30%	50	100	800 min.	1206
LQH31HN95NK01	95 ±10%	1	790	0.047 ±30%	60	100	650 min.	1206
LQH31HNR14J01	145 ±5%	1	700	0.061 ±30%	60	100	500 min.	1206
LQH31HNR14K01	145 ±10%	1	700	0.061 ±30%	60	100	500 min.	1206
LQH31HNR21J01	215 ±5%	1	520	0.11 ±30%	60	100	430 min.	1206
LQH31HNR21K01	215 ±10%	1	520	0.11 ±30%	60	100	430 min.	1206
LQH31HNR29J01	290 ±5%	1	420	0.17 ±30%	60	100	360 min.	1206
LQH31HNR29K01	290 ±10%	1	420	0.17 ±30%	60	100	360 min.	1206
LQH31HNR39J01	390 ±5%	1	330	0.26 ±30%	60	100	300 min.	1206
LQH31HNR39K01	390 ±10%	1	330	0.26 ±30%	60	100	300 min.	1206
LQH31HNR50J01	500 ±5%	1	260	0.44 ±30%	60	100	270 min.	1206
LQH31HNR50K01	500 ±10%	1	260	0.44 ±30%	60	100	270 min.	1206
LQH31HNR61J01	610 ±5%	1	250	0.48 ±30%	60	100	240 min.	1206
LQH31HNR61K01	610 ±10%	1	250	0.48 ±30%	60	100	240 min.	1206
LQH31HNR75J01	750 ±5%	1	190	0.79 ±30%	60	100	220 min.	1206
LQH31HNR75K01	750 ±10%	1	190	0.79 ±30%	60	100	220 min.	1206
LQH31HNR88J01	880 ±5%	1	180	0.86 ±30%	60	100	200 min.	1206
LQH31HNR88K01	880 ±10%	1	180	0.86 ±30%	60	100	200 min.	1206

Operating Temp. Range : -25°C to 85°C

■ Q-Frequency Characteristics

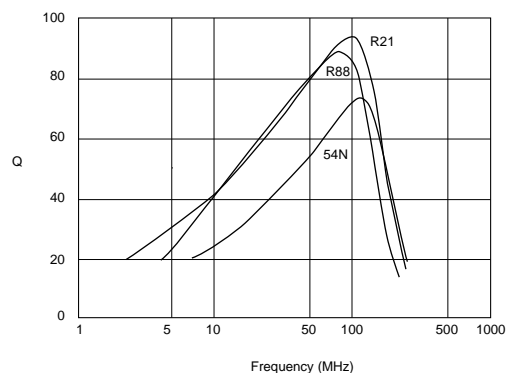

Chip Coils



for General Use Monolithic Type LQM18N/LQM21N Series

LQM18N Series

The LQM18N series, of magnetically shielded chip coil was developed by using original multilayer process technology and magnetic materials. Compact size is suitable for high density mounting. Shielded construction is not affected by interference from peripheral components.

■ Features

1. Magnetically shielded structure provides excellent characteristics in cross talk and magnetic coupling.
2. Compact size (1.6x0.8mm) and light weight.
3. The external electrodes with nickel barrier structure provide excellent solder heat resistance. Both flow and reflow soldering can be applicable.

■ Applications

- Resonance circuit, traps, filter circuits
- RF choke in telecommunication equipments, cordless phone, radio equipments

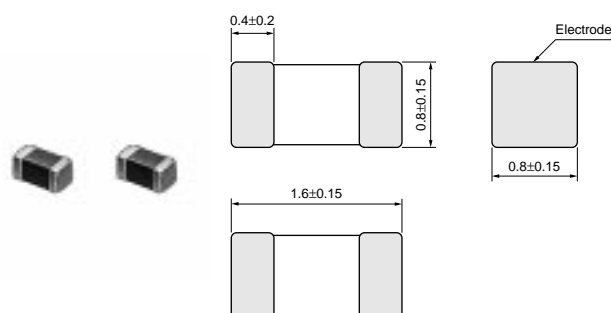

(in mm)

Part Number	Inductance (nH)	Test Frequency (MHz)	Rated Current (mA)	DC Resistance (ohm)	Q (min.)	Test Frequency (MHz)	Self Resonance Frequency (MHz)	EIA
LQM18NN47NM00	47 ±20%	50	50	0.30 max.	10	50	260 min.	0603
LQM18NN68NM00	68 ±20%	50	50	0.30 max.	10	50	250 min.	0603
LQM18NN82NM00	82 ±20%	50	50	0.30 max.	10	50	245 min.	0603
LQM18NNR10K00	100 ±10%	25	50	0.50 max.	15	25	240 min.	0603
LQM18NNR12K00	120 ±10%	25	50	0.50 max.	15	25	205 min.	0603
LQM18NNR15K00	150 ±10%	25	50	0.60 max.	15	25	180 min.	0603
LQM18NNR18K00	180 ±10%	25	50	0.60 max.	15	25	165 min.	0603
LQM18NNR22K00	220 ±10%	25	50	0.80 max.	15	25	150 min.	0603
LQM18NNR27K00	270 ±10%	25	50	0.80 max.	15	25	136 min.	0603
LQM18NNR33K00	330 ±10%	25	35	0.85 max.	15	25	125 min.	0603
LQM18NNR39K00	390 ±10%	25	35	1.00 max.	15	25	110 min.	0603
LQM18NNR47K00	470 ±10%	25	35	1.35 max.	15	25	105 min.	0603
LQM18NNR56K00	560 ±10%	25	35	1.55 max.	15	25	95 min.	0603
LQM18NNR68K00	680 ±10%	25	35	1.70 max.	15	25	90 min.	0603
LQM18NNR82K00	820 ±10%	25	35	2.10 max.	15	25	85 min.	0603
LQM18NN1R0K00	1000 ±10%	10	25	0.60 max.	35	10	75 min.	0603
LQM18NN1R2K00	1200 ±10%	10	25	0.80 max.	35	10	65 min.	0603
LQM18NN1R5K00	1500 ±10%	10	25	0.80 max.	35	10	60 min.	0603
LQM18NN1R8K00	1800 ±10%	10	25	0.95 max.	35	10	55 min.	0603
LQM18NN2R2K00	2200 ±10%	10	15	1.15 max.	35	10	50 min.	0603

Operating Temp. Range : -40°C to +85°C

■ Q-Frequency Characteristics

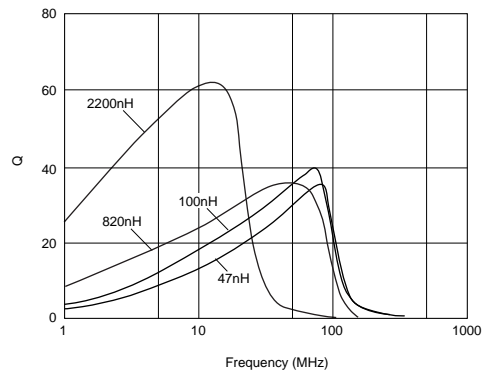

■ Inductance-Current Characteristics

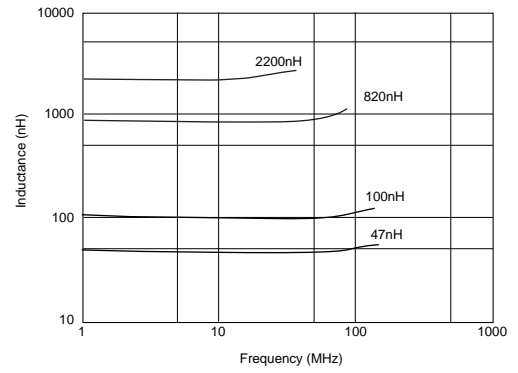

LQM21N Series

■ Features

The LQM21N series consists of magnetically shielded chip inductors developed using Murata's original multilayer process technology and magnetic materials. The miniature size of 2.0mmx1.25mm enables compact design of electric equipment. Inductance range from 0.10 micro H to 4.7 micro H are available.

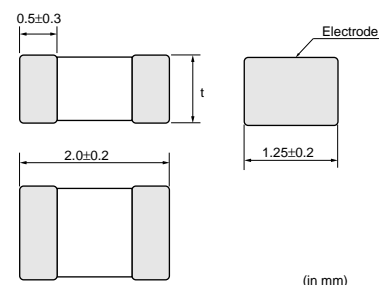

Part Number	t
LQM21NNR10K10 to N2R2K10	0.85±0.2
LQM21NN2R7K10 to N4R7K10	1.25±0.2

Part Number	Inductance (μH)	Test Frequency (MHz)	Rated Current (mA)	DC Resistance (ohm)	Q (min.)	Test Frequency (MHz)	Self Resonance Frequency (MHz)	EIA
LQM21NNR10K10	0.1 ±10%	25	250	0.26 max.	20	25	340 min.	0805
LQM21NNR12K10	0.12 ±10%	25	250	0.29 max.	20	25	310 min.	0805
LQM21NNR15K10	0.15 ±10%	25	250	0.32 max.	20	25	270 min.	0805
LQM21NNR18K10	0.18 ±10%	25	250	0.35 max.	20	25	250 min.	0805
LQM21NNR22K10	0.22 ±10%	25	250	0.38 max.	20	25	220 min.	0805
LQM21NNR27K10	0.27 ±10%	25	250	0.42 max.	20	25	200 min.	0805
LQM21NNR33K10	0.33 ±10%	25	250	0.48 max.	20	25	180 min.	0805
LQM21NNR39K10	0.39 ±10%	25	200	0.53 max.	25	25	165 min.	0805
LQM21NNR47K10	0.47 ±10%	25	200	0.57 max.	25	25	150 min.	0805
LQM21NNR56K10	0.56 ±10%	25	150	0.63 max.	25	25	140 min.	0805
LQM21NNR68K10	0.68 ±10%	25	150	0.72 max.	25	25	125 min.	0805
LQM21NNR82K10	0.82 ±10%	25	150	0.81 max.	25	25	115 min.	0805
LQM21NN1R0K10	1 ±10%	10	50	0.40 max.	45	10	107 min.	0805
LQM21NN1R2K10	1.2 ±10%	10	50	0.47 max.	45	10	97 min.	0805
LQM21NN1R5K10	1.5 ±10%	10	50	0.50 max.	45	10	87 min.	0805
LQM21NN1R8K10	1.8 ±10%	10	50	0.57 max.	45	10	80 min.	0805
LQM21NN2R2K10	2.2 ±10%	10	30	0.63 max.	45	10	71 min.	0805
LQM21NN2R7K10	2.7 ±10%	10	30	0.69 max.	45	10	66 min.	0805
LQM21NN3R3K10	3.3 ±10%	10	30	0.80 max.	45	10	59 min.	0805
LQM21NN3R9K10	3.9 ±10%	10	30	0.89 max.	45	10	53 min.	0805
LQM21NN4R7K10	4.7 ±10%	10	30	1.00 max.	45	10	47 min.	0805

Operating Temp. Range : -40°C to 85°C

■ Q-Frequency Characteristics

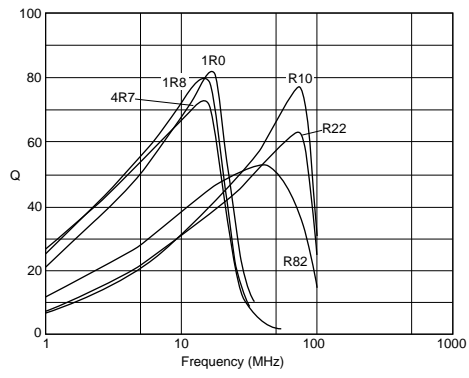

■ Inductance-Current Characteristics

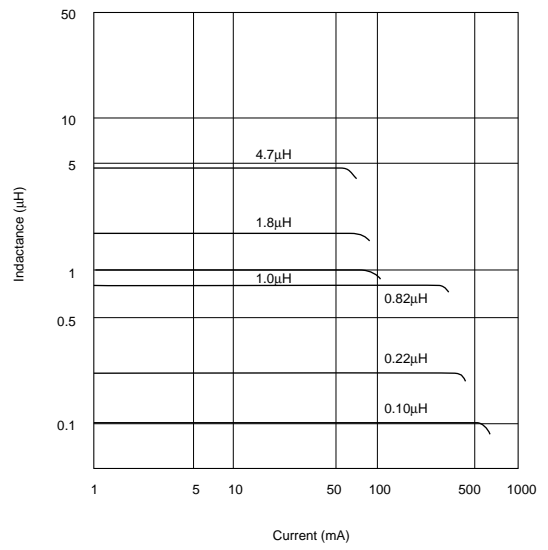

Chip Coils



for General Use Winding Type LQH31M/LQH32M/LQH43M (N) Series

LQH31M Series

■ Features

The chip inductor LQH31M series consists of miniature chip inductors wound on a special ferrite core. It have a high Q value at high frequencies and low DC resistance. Wide inductance range from 0.15 micro H to 100 micro H are available.

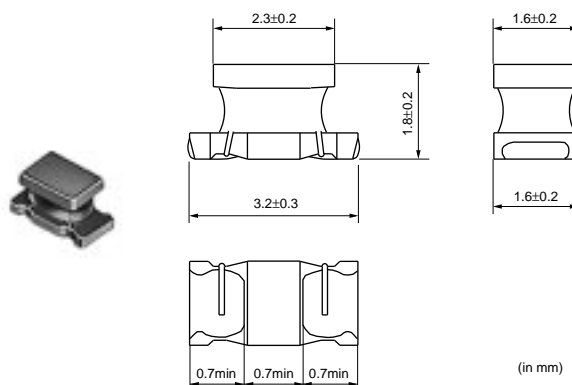

Part Number	Inductance (μH)	Test Frequency (MHz)	Rated Current (mA)	DC Resistance (ohm)	Q (min.)	Test Frequency (MHz)	Self Resonance Frequency (MHz)	EIA
LQH31MNR15K01	0.15 ±10%	1	250	0.39 ±40%	20	25	250 min.	1206
LQH31MNR22K01	0.22 ±10%	1	240	0.43 ±40%	20	25	250 min.	1206
LQH31MNR33K01	0.33 ±10%	1	230	0.45 ±40%	30	25	250 min.	1206
LQH31MNR47K01	0.47 ±10%	1	215	0.83 ±40%	30	25	200 min.	1206
LQH31MNR56K01	0.56 ±10%	1	200	0.61 ±40%	30	25	180 min.	1206
LQH31MNR68K01	0.68 ±10%	1	190	0.67 ±40%	30	25	160 min.	1206
LQH31MNR82K01	0.82 ±10%	1	185	0.73 ±40%	30	25	120 min.	1206
LQH31MN1R0K01	1.0 ±10%	1	175	0.49 ±30%	35	10	100 min.	1206
LQH31MN1R2K01	1.2 ±10%	1	165	0.9 ±30%	35	10	90 min.	1206
LQH31MN1R5J01	1.5 ±5%	1	155	1.0 ±30%	35	10	75 min.	1206
LQH31MN1R5K01	1.5 ±10%	1	155	1.0 ±30%	35	10	75 min.	1206
LQH31MN1R8J01	1.8 ±5%	1	150	1.6 ±30%	35	10	60 min.	1206
LQH31MN1R8K01	1.8 ±10%	1	150	1.6 ±30%	35	10	60 min.	1206
LQH31MN2R2J01	2.2 ±5%	1	140	0.7 ±30%	35	10	50 min.	1206
LQH31MN2R2K01	2.2 ±10%	1	140	0.7 ±30%	35	10	50 min.	1206
LQH31MN2R7J01	2.7 ±5%	1	135	0.55 ±30%	35	10	43 min.	1206
LQH31MN2R7K01	2.7 ±10%	1	135	0.55 ±30%	35	10	43 min.	1206
LQH31MN3R3J01	3.3 ±5%	1	130	1.4 ±30%	35	8	38 min.	1206
LQH31MN3R3K01	3.3 ±10%	1	130	1.4 ±30%	35	8	38 min.	1206
LQH31MN3R9J01	3.9 ±5%	1	125	1.5 ±30%	35	8	35 min.	1206
LQH31MN3R9K01	3.9 ±10%	1	125	1.5 ±30%	35	8	35 min.	1206
LQH31MN4R7J01	4.7 ±5%	1	120	1.7 ±30	35	8	31 min.	1206
LQH31MN4R7K01	4.7 ±10%	1	120	1.7 ±30%	35	8	31 min.	1206
LQH31MN5R6J01	5.6 ±5%	1	115	1.8 ±30%	35	8	28 min.	1206
LQH31MN5R6K01	5.6 ±10%	1	115	1.8 ±30%	35	8	28 min.	1206
LQH31MN6R8J01	6.8 ±5%	1	110	2.0 ±30%	35	8	25 min.	1206
LQH31MN6R8K01	6.8 ±10%	1	110	2.0 ±30%	35	8	25 min.	1206
LQH31MN8R2J01	8.2 ±5%	1	105	2.2 ±30%	35	8	23 min.	1206
LQH31MN8R2K01	8.2 ±10%	1	105	2.2 ±30%	35	8	23 min.	1206
LQH31MN100J01	10 ±5%	1	100	2.5 ±30%	35	5	20 min.	1206
LQH31MN100K01	10 ±10%	1	100	2.5 ±30%	35	5	20 min.	1206
LQH31MN120J01	12 ±5%	1	95	2.7 ±30%	35	5	18 min.	1206
LQH31MN120K01	12 ±10%	1	95	2.7 ±30%	35	5	18 min.	1206
LQH31MN150J01	15 ±5%	1	90	3.0 ±30%	35	5	16 min.	1206
LQH31MN150K01	15 ±10%	1	90	3 ±30%	35	5	16 min.	1206
LQH31MN180J01	18 ±5%	1	85	3.4 ±30%	35	5	15 min.	1206

Continued on the following page.

Continued from the preceding page.

Part Number	Inductance (μH)	Test Frequency (MHz)	Rated Current (mA)	DC Resistance (ohm)	Q (min.)	Test Frequency (MHz)	Self Resonance Frequency (MHz)	EIA
LQH31MN180K01	18 ±10%	1	85	3.4 ±30%	35	5	15 min.	1206
LQH31MN220J01	22 ±5%	1	85	3.1 ±30%	40	2.5	14 min.	1206
LQH31MN220K01	22 ±10%	1	85	3.1 ±30%	40	2.5	14 min.	1206
LQH31MN270J01	27 ±5%	1	85	3.4 ±30%	40	2.5	13 min.	1206
LQH31MN270K01	27 ±10%	1	85	3.4 ±30%	40	2.5	13 min.	1206
LQH31MN330J01	33 ±5%	1	80	3.8 ±30%	40	2.5	12 min.	1206
LQH31MN330K01	33 ±10%	1	80	3.8 ±30%	40	2.5	12 min.	1206
LQH31MN390J01	39 ±5%	1	55	7.2 ±30%	40	2.5	11 min.	1206
LQH31MN390K01	39 ±10%	1	55	7.2 ±30%	40	2.5	11 min.	1206
LQH31MN470J01	47 ±5%	1	55	8 ±30%	40	2.5	10 min.	1206
LQH31MN470K01	47 ±10%	1	55	8.0 ±30%	40	2.5	10 min.	1206
LQH31MN560J01	56 ±5%	1	50	8.9 ±30%	40	2.5	9 min.	1206
LQH31MN560K01	56 ±10%	1	50	8.9 ±30%	40	2.5	9 min.	1206
LQH31MN680J01	68 ±5%	1	50	9.9 ±30%	40	2.5	8.5 min.	1206
LQH31MN680K01	68 ±10%	1	50	9.9 ±30%	40	2.5	8.5 min.	1206
LQH31MN820J01	82 ±5%	1	45	11 ±30%	40	2.5	7.5 min.	1206
LQH31MN820K01	82 ±10%	1	45	11 ±30%	40	2.5	7.5 min.	1206
LQH31MN101J01	100 ±5%	1	45	12 ±30%	40	2.5	7 min.	1206
LQH31MN101K01	100 ±10%	1	45	12 ±30%	40	2.5	7 min.	1206

Operating Temp. Range : -25°C to 85°C

7

■ Q-Frequency Characteristics

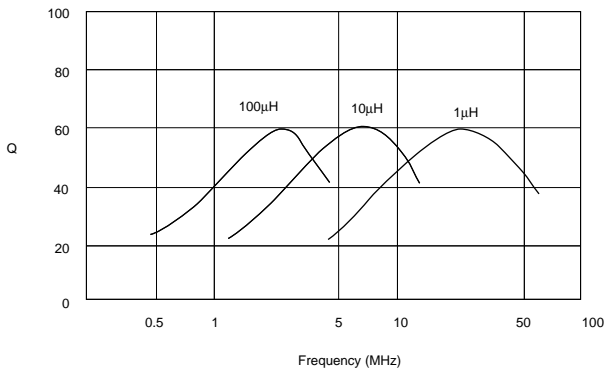

■ Inductance-Current Characteristics

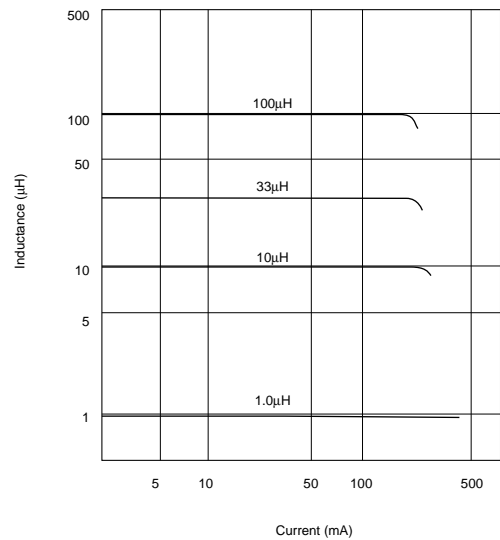

■ Coupling Coefficient

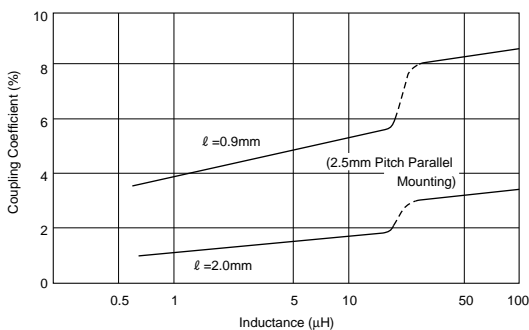

LQH32M Series

■ Features

The chip inductor LQH32M series consists of miniature chip inductors wound on a special ferrite core. It have a high Q value at high frequencies and low DC resistance. Wide inductance range from 1.0 micro H to 560 micro H are available.

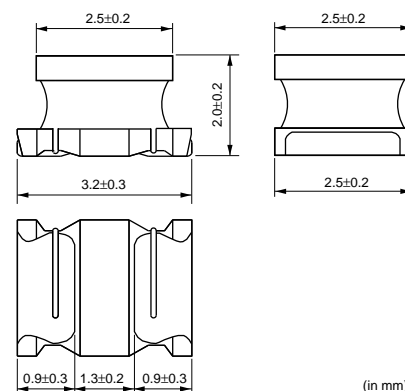

Part Number	Inductance (μH)	Test Frequency	Rated Current (mA)	DC Resistance (ohm)	Q (min.)	Test Frequency	Self Resonance Frequency (MHz)	EIA
LQH32MN1R0M21	1 ±20%	1MHz	445	0.5 max.	20	1MHz	100 min.	1210
LQH32MN1R2M21	1.2 ±20%	1MHz	425	0.6 max.	20	1MHz	100 min.	1210
LQH32MN1R5K21	1.5 ±10%	1MHz	400	0.6 max.	20	1MHz	75 min.	1210
LQH32MN1R8K21	1.8 ±10%	1MHz	390	0.7 max.	20	1MHz	60 min.	1210
LQH32MN2R2K21	2.2 ±10%	1MHz	370	0.8 max.	20	1MHz	50 min.	1210
LQH32MN2R7K21	2.7 ±10%	1MHz	320	0.9 max.	20	1MHz	43 min.	1210
LQH32MN3R3K21	3.3 ±10%	1MHz	300	1.0 max.	20	1MHz	38 min.	1210
LQH32MN3R9K21	3.9 ±10%	1MHz	290	1.1 max.	20	1MHz	35 min.	1210
LQH32MN4R7K21	4.7 ±10%	1MHz	270	1.2 max.	20	1MHz	31 min.	1210
LQH32MN5R6K21	5.6 ±10%	1MHz	250	1.3 max.	20	1MHz	28 min.	1210
LQH32MN6R8K21	6.8 ±10%	1MHz	240	1.5 max.	20	1MHz	25 min.	1210
LQH32MN8R2K21	8.2 ±10%	1MHz	225	1.6 max.	20	1MHz	23 min.	1210
LQH32MN100J21	10 ±5%	1MHz	190	1.8 max.	35	1MHz	20 min.	1210
LQH32MN100K21	10 ±10%	1MHz	190	1.8 max.	35	1MHz	20 min.	1210
LQH32MN120J21	12 ±5%	1MHz	180	2.0 max.	35	1MHz	18 min.	1210
LQH32MN120K21	12 ±10%	1MHz	180	2.0 max.	35	1MHz	18 min.	1210
LQH32MN150J21	15 ±5%	1MHz	170	2.2 max.	35	1MHz	16 min.	1210
LQH32MN150K21	15 ±10%	1MHz	170	2.2 max.	35	1MHz	16 min.	1210
LQH32MN180J21	18 ±5%	1MHz	165	2.5 max.	35	1MHz	15 min.	1210
LQH32MN180K21	18 ±10%	1MHz	165	2.5 max.	35	1MHz	15 min.	1210
LQH32MN220J21	22 ±5%	1MHz	150	2.8 max.	35	1MHz	14 min.	1210
LQH32MN220K21	22 ±10%	1MHz	150	2.8 max.	35	1MHz	14 min.	1210
LQH32MN270J21	27 ±5%	1MHz	125	3.1 max.	35	1MHz	13 min.	1210
LQH32MN270K21	27 ±10%	1MHz	125	3.1 max.	35	1MHz	13 min.	1210
LQH32MN330J21	33 ±5%	1MHz	115	3.5 max.	40	1MHz	12 min.	1210
LQH32MN330K21	33 ±10%	1MHz	115	3.5 max.	40	1MHz	12 min.	1210
LQH32MN390J21	39 ±5%	1MHz	110	3.9 max.	40	1MHz	11 min.	1210
LQH32MN390K21	39 ±10%	1MHz	110	3.9 max.	40	1MHz	11 min.	1210
LQH32MN470J21	47 ±5%	1MHz	100	4.3 max.	40	1MHz	11 min.	1210
LQH32MN470K21	47 ±10%	1MHz	100	4.3 max.	40	1MHz	11 min.	1210
LQH32MN560J21	56 ±5%	1MHz	85	4.9 max.	40	1MHz	10 min.	1210
LQH32MN560K21	56 ±10%	1MHz	85	4.9 max.	40	1MHz	10 min.	1210
LQH32MN680J21	68 ±5%	1MHz	80	5.5 max.	40	1MHz	9 min.	1210
LQH32MN680K21	68 ±10%	1MHz	80	5.5 max.	40	1MHz	9 min.	1210
LQH32MN820J21	82 ±5%	1MHz	70	6.2 max.	40	1MHz	8.5 min.	1210
LQH32MN820K21	82 ±10%	1MHz	70	6.2 max.	40	1MHz	8.5 min.	1210
LQH32MN101J21	100 ±5%	1MHz	80	7 max.	40	796kHz	8 min.	1210
LQH32MN101K21	100 ±10%	1MHz	80	7 max.	40	796kHz	8 min.	1210
LQH32MN121J21	120 ±5%	1MHz	75	8.0 max.	40	796kHz	7.5 min.	1210
LQH32MN121K21	120 ±10%	1MHz	75	8.0 max.	40	796kHz	7.5 min.	1210
LQH32MN151J21	150 ±5%	1MHz	70	9.3 max.	40	796kHz	7 min.	1210
LQH32MN151K21	150 ±10%	1MHz	70	9.3 max.	40	796kHz	7 min.	1210

Continued on the following page.

Continued from the preceding page.

Part Number	Inductance (μH)	Test Frequency	Rated Current (mA)	DC Resistance (ohm)	Q (min.)	Test Frequency	Self Resonance Frequency (MHz)	EIA
LQH32MN181J21	180 ±5%	1MHz	65	10.2 max.	40	796kHz	6 min.	1210
LQH32MN181K21	180 ±10%	1MHz	65	10.2 max.	40	796kHz	6 min.	1210
LQH32MN221J21	220 ±5%	1MHz	65	11.8 max.	40	796kHz	5.5 min.	1210
LQH32MN221K21	220 ±10%	1MHz	65	11.8 max.	40	796kHz	5.5 min.	1210
LQH32MN271J21	270 ±5%	1MHz	65	12.5 max.	40	796kHz	5 min.	1210
LQH32MN271K21	270 ±10%	1MHz	65	12.5 max.	40	796kHz	5 min.	1210
LQH32MN331J21	330 ±5%	1MHz	65	13.0 max.	40	796kHz	5 min.	1210
LQH32MN331K21	330 ±10%	1MHz	65	13.0 max.	40	796kHz	5 min.	1210
LQH32MN391J21	390 ±5%	1MHz	50	22.0 max.	50	796MHz	5 min.	1210
LQH32MN391K21	390 ±10%	1MHz	50	22.0 max.	50	796kHz	5 min.	1210
LQH32MN471J21	470 ±5%	1kHz	45	25.0 max.	50	796kHz	5 min.	1210
LQH32MN471K21	470 ±10%	1kHz	45	25.0 max.	50	796kHz	5 min.	1210
LQH32MN561J21	560 ±5%	1kHz	40	28.0 max.	50	796kHz	5 min.	1210
LQH32MN561K21	560 ±10%	1kHz	40	28.0 max.	50	796kHz	5 min.	1210

Operating Temp. Range : -25°C to 85°C

Q-Frequency Characteristics

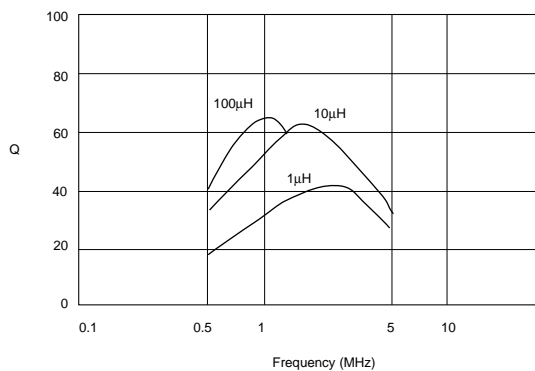

Inductance-Current Characteristics

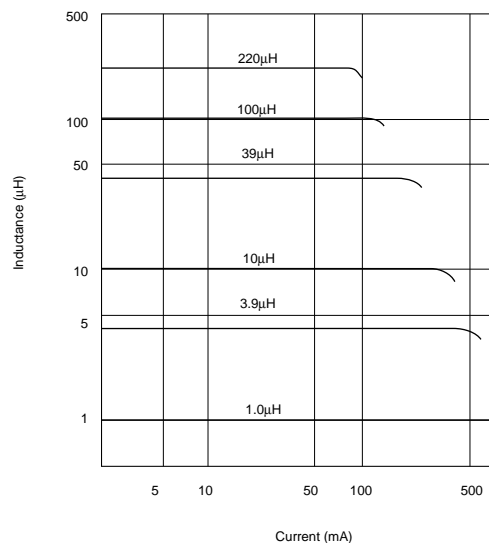

LQH43M/N Series

■ Features

The chip inductor LQH43M/N series consists of miniature chip inductors wound on a special ferrite core. It have a high Q value at high frequencies and low DC resistance.

Wide inductance range from 1.0 micro H to 2200 micro H are available.

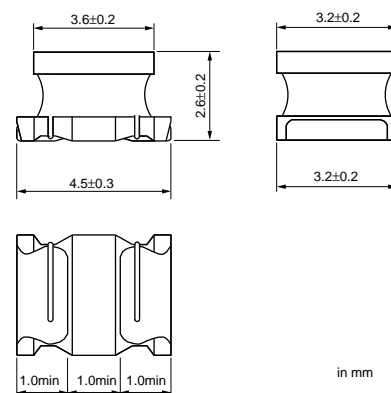

in mm

Part Number	Inductance (μH)	Test Frequency	Rated Current (mA)	DC Resistance (ohm)	Q (min.)	Test Frequency	Self Resonance Frequency (MHz)	EIA
LQH43MN1R0M01	1 ±20%	1MHz	500	0.20 max.	20	1MHz	120 min.	1812
LQH43MN1R2M01	1.2 ±20%	1MHz	500	0.20 max.	20	1MHz	100 min.	1812
LQH43MN1R5M01	1.5 ±20%	1MHz	500	0.30 max.	20	1MHz	85 min.	1812
LQH43MN1R8M01	1.8 ±20%	1MHz	500	0.30 max.	20	1MHz	75 min.	1812
LQH43MN2R2M01	2.2 ±20%	1MHz	500	0.30 max.	20	1MHz	62 min.	1812
LQH43MN2R7M01	2.7 ±20%	1MHz	500	0.32 max.	20	1MHz	53 min.	1812
LQH43MN3R3M01	3.3 ±20%	1MHz	500	0.35 max.	20	1MHz	47 min.	1812
LQH43MN3R9M01	3.9 ±20%	1MHz	500	0.38 max.	20	1MHz	41 min.	1812
LQH43MN4R7K01	4.7 ±10%	1MHz	500	0.40 max.	30	1MHz	38 min.	1812
LQH43MN5R6K01	5.6 ±10%	1MHz	500	0.47 max.	30	1MHz	33 min.	1812
LQH43MN6R8K01	6.8 ±10%	1MHz	450	0.50 max.	30	1MHz	31 min.	1812
LQH43MN8R2K01	8.2 ±10%	1MHz	450	0.56 max.	30	1MHz	27 min.	1812
LQH43MN100J01	10 ±5%	1MHz	400	0.56 max.	35	1MHz	23 min.	1812
LQH43MN100K01	10 ±10%	1MHz	400	0.56 max.	35	1MHz	23 min.	1812
LQH43MN120J01	12 ±5%	1MHz	380	0.62 max.	35	1MHz	21 min.	1812
LQH43MN120K01	12 ±10%	1MHz	380	0.62 max.	35	1MHz	21 min.	1812
LQH43MN150J01	15 ±5%	1MHz	360	0.73 max.	35	1MHz	19 min.	1812
LQH43MN150K01	15 ±10%	1MHz	360	0.73 max.	35	1MHz	19 min.	1812
LQH43MN180J01	18 ±5%	1MHz	340	0.82 max.	35	1MHz	17 min.	1812
LQH43MN180K01	18 ±10%	1MHz	340	0.82 max.	35	1MHz	17 min.	1812
LQH43MN220J01	22 ±5%	1MHz	320	0.94 max.	35	1MHz	15 min.	1812
LQH43MN220K01	22 ±10%	1MHz	320	0.94 max.	35	1MHz	15 min.	1812
LQH43MN270J01	27 ±5%	1MHz	300	1.1 max.	35	1MHz	14 min.	1812
LQH43MN270K01	27 ±10%	1MHz	300	1.1 max.	35	1MHz	14 min.	1812
LQH43MN330J01	33 ±5%	1MHz	270	1.2 max.	35	1MHz	12 min.	1812
LQH43MN330K01	33 ±10%	1MHz	270	1.2 max.	35	1MHz	12 min.	1812
LQH43MN390J01	39 ±5%	1MHz	240	1.4 max.	35	1MHz	11 min.	1812
LQH43MN390K01	39 ±10%	1MHz	240	1.4 max.	35	1MHz	11 min.	1812
LQH43MN470J01	47 ±5%	1MHz	220	1.5 max.	35	1MHz	10 min.	1812
LQH43MN470K01	47 ±10%	1MHz	220	1.5 max.	35	1MHz	10 min.	1812
LQH43MN560J01	56 ±5%	1MHz	200	1.7 max.	35	1MHz	9.3 min.	1812
LQH43MN560K01	56 ±10%	1MHz	200	1.7 max.	35	1MHz	9.3 min.	1812
LQH43MN680J01	68 ±5%	1MHz	180	1.9 max.	35	1MHz	8.4 min.	1812
LQH43MN680K01	68 ±10%	1MHz	180	1.9 max.	35	1MHz	8.4 min.	1812
LQH43MN820J01	82 ±5%	1MHz	170	2.2 max.	35	1MHz	7.5 min.	1812
LQH43MN820K01	82 ±10%	1MHz	170	2.2 max.	35	1MHz	7.5 min.	1812
LQH43MN101J01	100 ±5%	1MHz	160	2.5 max.	40	796kHz	6.8 min.	1812
LQH43MN101K01	100 ±10%	1MHz	160	2.5 max.	40	796kHz	6.8 min.	1812
LQH43MN121J01	120 ±5%	1MHz	150	3.0 max.	40	796kHz	6.2 min.	1812
LQH43MN121K01	120 ±10%	1MHz	150	3.0 max.	40	796kHz	6.2 min.	1812
LQH43MN151J01	150 ±5%	1MHz	130	3.7 max.	40	796kHz	5.5 min.	1812
LQH43MN151K01	150 ±10%	1MHz	130	3.7 max.	40	796kHz	5.5 min.	1812

Continued on the following page.

Continued from the preceding page.

Part Number	Inductance (μH)	Test Frequency	Rated Current (mA)	DC Resistance (ohm)	Q (min.)	Test Frequency	Self Resonance Frequency (MHz)	EIA
LQH43MN181J01	180 ±5%	1MHz	120	4.5 max.	40	796kHz	5 min.	1812
LQH43MN181K01	180 ±10%	1MHz	120	4.5 max.	40	796kHz	5 min.	1812
LQH43MN221J01	220 ±5%	1MHz	110	5.4 max.	40	796kHz	4.5 min.	1812
LQH43MN221K01	220 ±10%	1MHz	110	5.4 max.	40	796kHz	4.5 min.	1812
LQH43MN271J01	270 ±5%	1MHz	100	6.8 max.	40	796kHz	4 min.	1812
LQH43MN271K01	270 ±10%	1MHz	100	6.8 max.	40	796kHz	4 min.	1812
LQH43MN331J01	330 ±5%	1MHz	95	8.2 max.	40	796kHz	3.6 min.	1812
LQH43MN331K01	330 ±10%	1MHz	95	8.2 max.	40	796kHz	3.6 min.	1812
LQH43MN391J01	390 ±5%	1MHz	90	9.7 max.	40	796kHz	3.3 min.	1812
LQH43MN391K01	390 ±10%	1MHz	90	9.7 max.	40	796kHz	3.3 min.	1812
LQH43MN471J01	470 ±5%	1kHz	80	11.8 max.	40	796kHz	3 min.	1812
LQH43MN471K01	470 ±10%	1kHz	80	11.8 max.	40	796kHz	3 min.	1812
LQH43MN561J01	560 ±5%	1kHz	70	14.5 max.	40	796kHz	2.7 min.	1812
LQH43MN561K01	560 ±10%	1kHz	70	14.5 max.	40	796kHz	2.7 min.	1812
LQH43MN681J01	680 ±5%	1kHz	65	17.0 max.	40	796kHz	2.5 min.	1812
LQH43MN681K01	680 ±10%	1kHz	65	17.0 max.	40	796kHz	2.5 min.	1812
LQH43MN821J01	820 ±5%	1kHz	60	20.5 max.	40	796kHz	2.2 min.	1812
LQH43MN821K01	820 ±10%	1kHz	60	20.5 max.	40	796kHz	2.2 min.	1812
LQH43MN102J01	1000 ±5%	1kHz	50	25.0 max.	40	252kHz	2 min.	1812
LQH43MN102K01	1000 ±10%	1kHz	50	25.0 max.	40	252kHz	2 min.	1812
LQH43MN122J01	1200 ±5%	1kHz	45	30.0 max.	40	252kHz	1.8 min.	1812
LQH43MN122K01	1200 ±10%	1kHz	45	30.0 max.	40	252kHz	1.8 min.	1812
LQH43MN152J01	1500 ±5%	1kHz	40	37.0 max.	40	252kHz	1.6 min.	1812
LQH43MN152K01	1500 ±10%	1kHz	40	37.0 max.	40	252kHz	1.6 min.	1812
LQH43NN182J01	1800 ±5%	1kHz	35	45.0 max.	40	252kHz	1.5 min.	1812
LQH43NN182K01	1800 ±10%	1kHz	35	45.0 max.	40	252kHz	1.5 min.	1812
LQH43NN222J01	2200 ±5%	1kHz	30	50.0 max.	40	252kHz	1.3 min.	1812
LQH43NN222K01	2200 ±10%	1kHz	30	50.0 max.	40	252kHz	1.3 min.	1812

Operating Temp. Range : -25°C to 85°C

Q-Frequency Characteristics

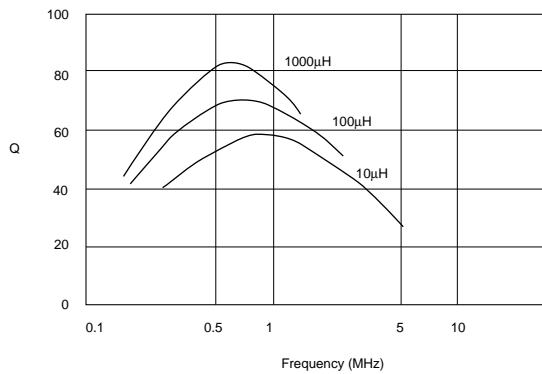

Inductance-Current Characteristics

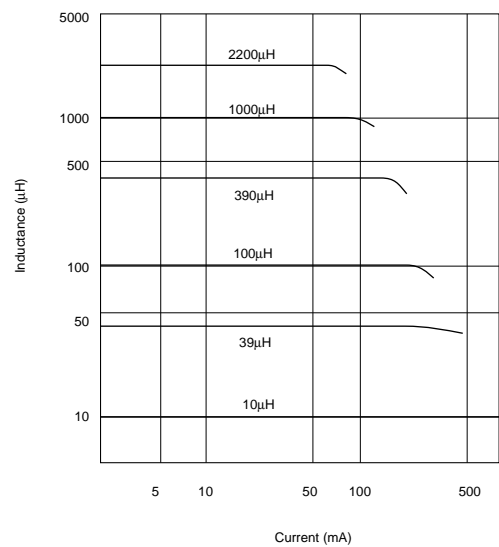

Chip Coils



for General Use Magnetic Shielded Type LQH3ER Series

■ Features

The LQH3ER series consists of magnetically shielded chip inductors. Its tight inductance tolerance of $\pm 2\%$ enables no adjustment of circuit. The shielding structure eliminates external interference and facilitates high mounting density.

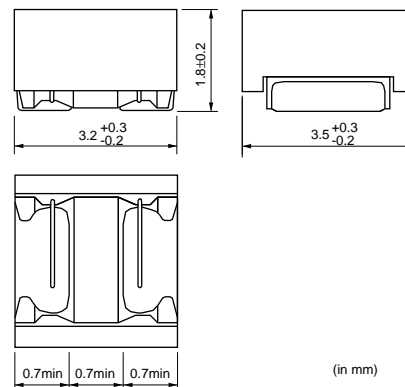

Part Number	Inductance (μH)	Test Frequency (MHz)	Rated Current (mA)	DC Resistance (ohm)	Q (min.)	Test Frequency (MHz)	Self Resonance Frequency (MHz)	EIA
LQH3ERN1R0G01	1 ±2%	7.96	70	0.19 ±30%	60	7.96	120 min.	1214
LQH3ERN1R0J01	1 ±5%	7.96	70	0.19 ±30%	60	7.96	120 min.	1214
LQH3ERN1R2G01	1.2 ±2%	7.96	70	0.22 ±30%	60	7.96	100 min.	1214
LQH3ERN1R2J01	1.2 ±5%	7.96	70	0.22 ±30%	60	7.96	100 min.	1214
LQH3ERN1R5G01	1.5 ±2%	7.96	70	0.26 ±30%	60	7.96	80 min.	1214
LQH3ERN1R5J01	1.5 ±5%	7.96	70	0.26 ±30%	60	7.96	80 min.	1214
LQH3ERN1R8G01	1.8 ±2%	7.96	70	0.28 ±30%	60	7.96	70 min.	1214
LQH3ERN1R8J01	1.8 ±5%	7.96	70	0.28 ±30%	60	7.96	70 min.	1214
LQH3ERN2R2G01	2.2 ±2%	7.96	50	0.33 ±30%	60	7.96	60 min.	1214
LQH3ERN2R2J01	2.2 ±5%	7.96	50	0.33 ±30%	60	7.96	60 min.	1214
LQH3ERN2R7G01	2.7 ±2%	7.96	50	0.39 ±30%	60	7.96	55 min.	1214
LQH3ERN2R7J01	2.7 ±5%	7.96	50	0.39 ±30%	60	7.96	55 min.	1214
LQH3ERN3R3G01	3.3 ±2%	7.96	50	0.43 ±30%	60	7.96	50 min.	1214
LQH3ERN3R3J01	3.3 ±5%	7.96	50	0.43 ±30%	60	7.96	50 min.	1214
LQH3ERN3R9G01	3.9 ±2%	7.96	50	0.45 ±30%	60	7.96	45 min.	1214
LQH3ERN3R9J01	3.9 ±5%	7.96	50	0.45 ±30%	60	7.96	45 min.	1214
LQH3ERN4R7G01	4.7 ±2%	7.96	30	0.52 ±30%	60	7.96	40 min.	1214
LQH3ERN4R7J01	4.7 ±5%	7.96	30	0.52 ±30%	60	7.96	40 min.	1214
LQH3ERN5R6G01	5.6 ±2%	7.96	30	0.56 ±30%	60	7.96	37 min.	1214
LQH3ERN5R6J01	5.6 ±5%	7.96	30	0.56 ±30%	60	7.96	37 min.	1214
LQH3ERN6R8G01	6.8 ±2%	7.96	30	0.62 ±30%	60	7.96	35 min.	1214
LQH3ERN6R8J01	6.8 ±5%	7.96	30	0.62 ±30%	60	7.96	35 min.	1214
LQH3ERN8R2G01	8.2 ±2%	7.96	30	0.69 ±30%	60	7.96	32 min.	1214
LQH3ERN8R2J01	8.2 ±5%	7.96	30	0.69 ±30%	60	7.96	32 min.	1214
LQH3ERN100G01	10 ±2%	2.52	15	0.94 ±30%	70	2.52	30 min.	1214
LQH3ERN100J01	10 ±5%	2.52	15	0.94 ±30%	70	2.52	30 min.	1214
LQH3ERN120G01	12 ±2%	2.52	15	1.1 ±30%	70	2.52	27 min.	1214
LQH3ERN120J01	12 ±5%	2.52	15	1.1 ±30%	70	2.52	27 min.	1214
LQH3ERN150G01	15 ±2%	2.52	15	1.2 ±30%	70	2.52	25 min.	1214
LQH3ERN150J01	15 ±5%	2.52	15	1.2 ±30%	70	2.52	25 min.	1214
LQH3ERN180G01	18 ±2%	2.52	15	1.3 ±30%	70	2.52	23 min.	1214
LQH3ERN180J01	18 ±5%	2.52	15	1.3 ±30%	70	2.52	23 min.	1214
LQH3ERN220G01	22 ±2%	2.52	10	1.5 ±30%	70	2.52	20 min.	1214
LQH3ERN220J01	22 ±5%	2.52	10	1.5 ±30%	70	2.52	20 min.	1214
LQH3ERN270G01	27 ±2%	2.52	10	1.7 ±30%	70	2.52	18 min.	1214
LQH3ERN270J01	27 ±5%	2.52	10	1.7 ±30%	70	2.52	18 min.	1214
LQH3ERN330G01	33 ±2%	2.52	10	2.4 ±30%	80	2.52	16 min.	1214
LQH3ERN330J01	33 ±5%	2.52	10	2.4 ±30%	80	2.52	16 min.	1214

Continued on the following page.

Continued from the preceding page.

Part Number	Inductance (μH)	Test Frequency (MHz)	Rated Current (mA)	DC Resistance (ohm)	Q (min.)	Test Frequency (MHz)	Self Resonance Frequency (MHz)	EIA
LQH3ERN390G01	39 ±2%	2.52	10	2.6 ±30%	80	2.52	15 min.	1214
LQH3ERN390J01	39 ±5%	2.52	10	2.6 ±30%	80	2.52	15 min.	1214
LQH3ERN470G01	47 ±2%	2.52	10	3.0 ±30%	80	2.52	14 min.	1214
LQH3ERN470J01	47 ±5%	2.52	10	3 ±30%	80	2.52	14 min.	1214
LQH3ERN560G01	56 ±2%	2.52	10	3.3 ±30%	80	2.52	13 min.	1214
LQH3ERN560J01	56 ±5%	2.52	10	3.3 ±30%	80	2.52	13 min.	1214
LQH3ERN680G01	68 ±2%	2.52	10	5.3 ±30%	80	2.52	12 min.	1214
LQH3ERN680J01	68 ±5%	2.52	10	5.3 ±30%	80	2.52	12 min.	1214
LQH3ERN820G01	82 ±2%	2.52	10	5.8 ±30%	80	2.52	11 min.	1214
LQH3ERN820J01	82 ±5%	2.52	10	5.8 ±30%	80	2.52	11 min.	1214
LQH3ERN101G01	100 ±2%	2.52	10	6.6 ±30%	80	2.52	10 min.	1214
LQH3ERN101J01	100 ±5%	2.52	10	6.6 ±30%	80	2.52	10 min.	1214

Operating Temp. Range : -25°C to 85°C

Q-Frequency Characteristics

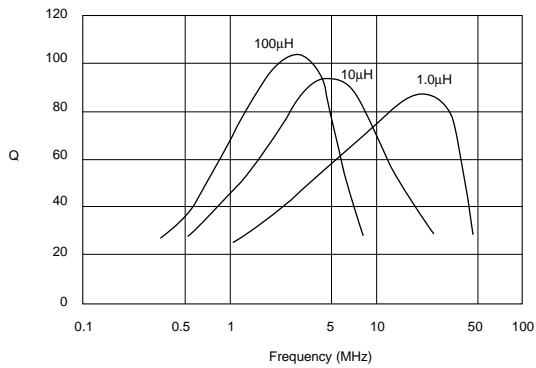

Inductance-Current Characteristics

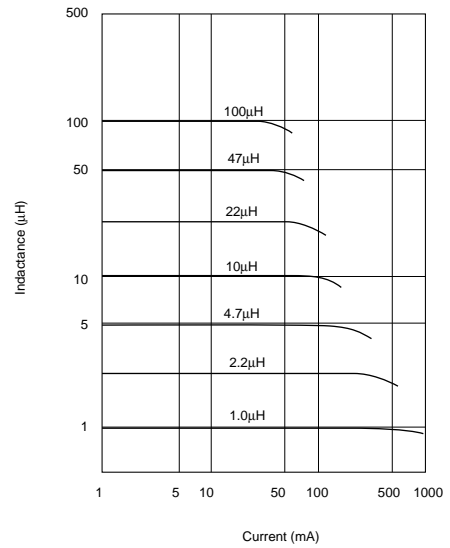

Coupling Coefficient

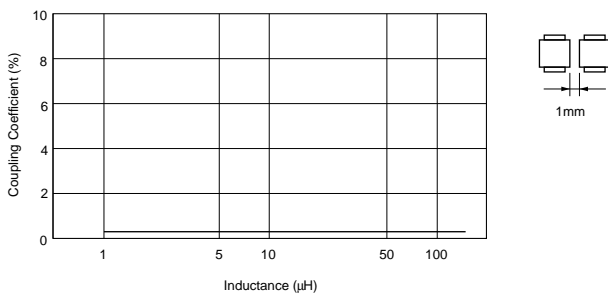

Chip Coils



for Choke Monolithic Type LQM21D/LQM21F/LQM31F Series

LQM21D Series

The LQM21D series consists of magnetically shielded chip inductors. It has less than half the DC resistance of our conventional monolithic chip inductors as well as high inductance.

■ Features

1. The inductors have very low DC resistance.
2. The series has an inductance range of 1.0 micro H to 47 micro H.
3. Magnetically shielded structure provides excellent crosstalk characteristics.
4. Compact (2.0x1.25mm) and lightweight.
5. Outstanding solder heat resistance. Either flow or reflow soldering methods can be employed.



LQM21D

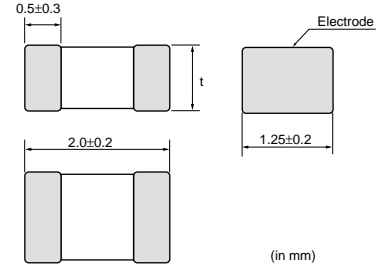

Part Number	t
LQM21DN1R0N00 to N100N00	0.85±0.2
LQM21DN220N00 to N470N00	1.25±0.2

Part Number	Inductance (μH)	Test Frequency (MHz)	Rated Current (mA)	DC Resistance (ohm)	Self Resonance Frequency (MHz)	EIA
LQM21DN1R0N00	1 ±30%	1	60	0.10 max.	75 min.	0805
LQM21DN2R2N00	2.2 ±30%	1	40	0.17 max.	50 min.	0805
LQM21DN4R7N00	4.7 ±30%	1	30	0.30 max.	35 min.	0805
LQM21DN100N00	10 ±30%	1	15	0.50 max.	24 min.	0805
LQM21DN220N00	22 ±30%	1	13	0.65 max.	16 min.	0805
LQM21DN470N00	47 ±30%	1	7	1.20 max.	7.5 min.	0805

Operating Temp. Range : -40°C to 85°C

■ Impedance-Frequency Characteristics

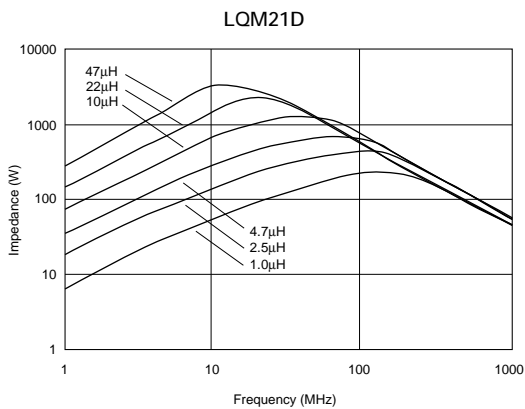

LQM21F Series

The LQM21F series consists of magnetically shielded chip coils based on Murata's technologies of multilayer process and magnetic materials. Excellent direct current characteristics are realized by using magnetic materials which have excellent saturation characteristics. The inductance of LQM21F is four times as large as that of conventional items.



LQM21F

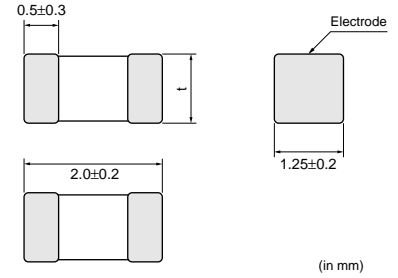

(in mm)

Part Number	t
LQM21FN1R0N00 to N2R2N00	0.85±0.2
LQM21FN4R7N00 to N470N00	1.25±0.2

■ Features

1. LQM21F series is suitable for power line choke because of its excellent direct current characteristics. the series has large rated current (60mA at 10 micro H) than conventional rated current.
2. Low DC Resistance is realized.
3. The cross talk characteristics are excellent because of the use of magnetically shielded structure.
4. Small size (2.0x1.25mm) and light weight.
5. The series has excellent solder heat resistance. Both flow and reflow soldering can be employed.

Part Number	Inductance (μH)	Test Frequency (MHz)	Rated Current (mA)	DC Resistance (ohm)	Self Resonance Frequency (MHz)	EIA
LQM21FN1R0N00	1.0 ±30%	1	220	0.20 ±30%	105 min.	0805
LQM21FN2R2N00	2.2 ±30%	1	150	0.28 ±30%	70 min.	0805
LQM21FN4R7N00	4.7 ±30%	1	80	0.30 ±30%	25 min.	0805
LQM21FN100N00	10 ±30%	1	60	0.50 ±30%	15 min.	0805
LQM21FN220N00	22 ±30%	1	13	0.35 ±30%	15 min.	0805
LQM21FN470N00	47 ±30%	1	7	0.60 ±30%	7.5 min.	0805

Operating Temp. Range : -40°C to 85°C

9

■ Impedance-Frequency Characteristics

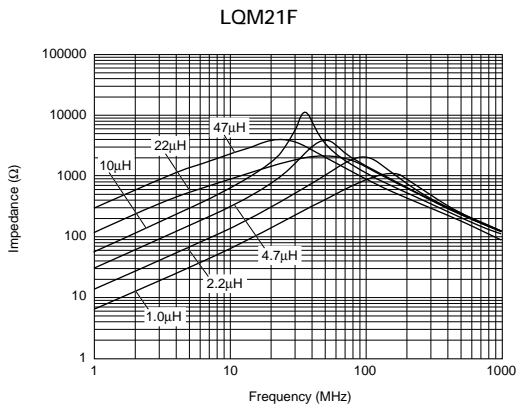

■ Inductance-Current Characteristics

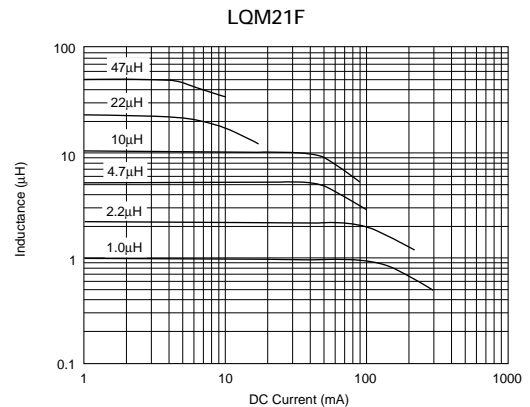

LQM31F Series

LQM31F series consists of magnetically shielded chip coils based on Murata's technologies of multilayer process and magnetic materials. Excellent direct current characteristics and low DC resistance are realized by using magnetic materials which have excellent saturation characteristics and high permeability.

■ Features

1. LQM31F series is suitable for power line choke because of its excellent direct current characteristics and large rated current. (70mA at 10 micro H)
2. Low DC resistance is realized.
3. The cross talk characteristics are excellent because of magnetically shielded structure.
4. Low profile 1.0mm.
5. The series has excellent solder heat resistance. Both flow and reflow soldering can be employed.

■ Applications

Circuits for DC power line choke of telecommunication equipments such as PDA, Note-PC, digital camera, PDA, MD and DVD-RAM

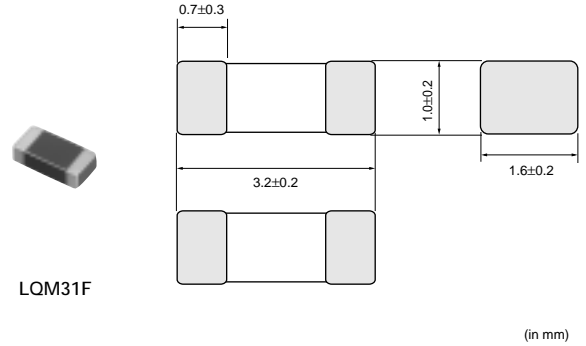

LQM31F

Part Number	Inductance (μH)	Test Frequency (MHz)	Rated Current (mA)	DC Resistance (ohm)	Self Resonance Frequency (MHz)	EIA
LQM31FN100M00	10 ±20%	1	70	0.50 max.	20 min.	1206

Operating Temp. Range : -40°C to 85°C

■ Impedance-Frequency Characteristics

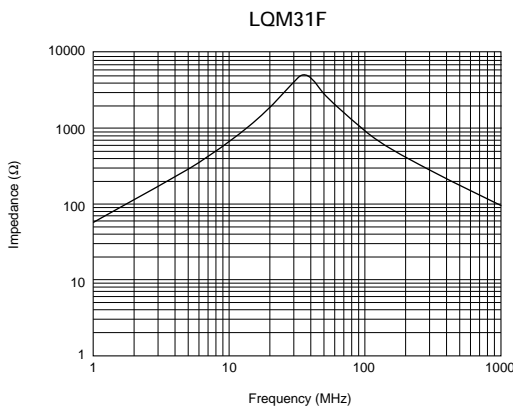

■ Inductance-Current Characteristics

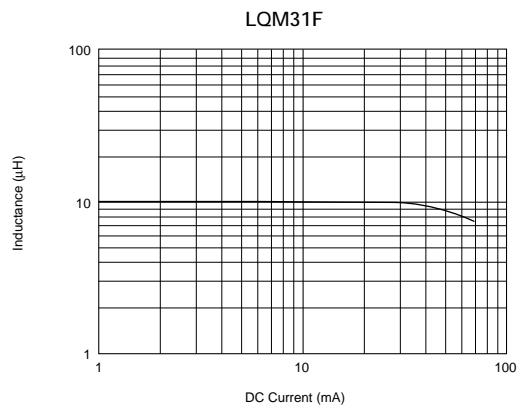

Chip Coils



for Choke Winding Type LQH31C/LQH32C/LQH43C Series

LQH31C Series

■ Features

The LQH31C series consists of miniature chip inductors with low DC resistance, high current capacity, and high impedance characteristics. It is suitable for use as choke coils in DC power supply circuits. High rated current up to 970mA is available.

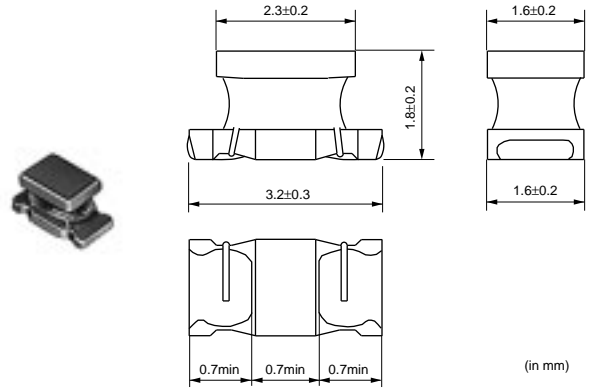

Part Number	Inductance (μH)	Test Frequency (MHz)	Rated Current (mA)	DC Resistance (ohm)	Self Resonance Frequency (MHz)	EIA
LQH31CNR12M01	0.12 ±20%	1	970	0.08 ±40%	250 min.	1206
LQH31CNR22M01	0.22 ±20%	1	850	0.1 ±40%	250 min.	1206
LQH31CNR47M01	0.47 ±20%	1	700	0.15 ±40%	180 min.	1206
LQH31CN1R0M01	1 ±20%	1	510	0.28 ±30%	100 min.	1206
LQH31CN2R2M01	2.2 ±20%	1	430	0.41 ±30%	50 min.	1206
LQH31CN4R7M01	4.7 ±20%	1	340	0.65 ±30%	31 min.	1206
LQH31CN100K01	10 ±10%	1	230	1.3 ±30%	20 min.	1206
LQH31CN220K01	22 ±10%	1	160	3.0 ±30%	14 min.	1206
LQH31CN470K01	47 ±10%	1	100	8.0 ±30%	10 min.	1206
LQH31CN101K01	100 ±10%	1	80	12 ±30%	7 min.	1206

Operating Temp. Range : -25°C to 85°C

10

■ Impedance-Frequency Characteristics

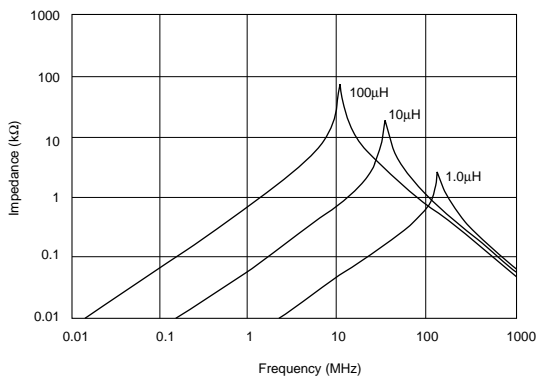

■ Inductance-Current Characteristics

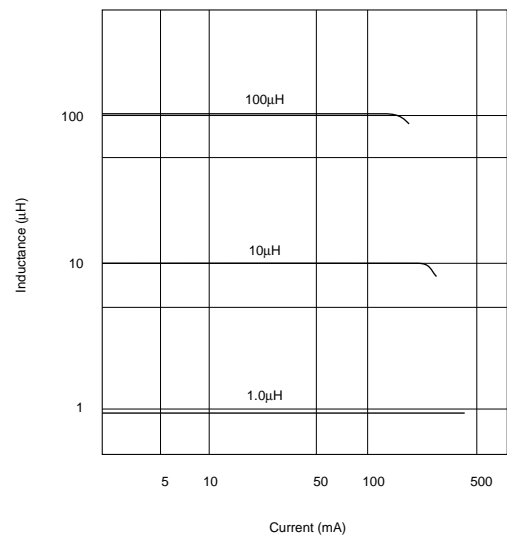

LQH32C_11/_21

The LQH32C series consists of miniature chip coils with low DC resistance, high current capacity, and high impedance characteristics.

These features are made possible by the development of Murata's innovative automatic winding techniques.

They are excellent for use as choke coils in DC power supply circuits.

■ Features (LQH32C_11/_21)

1. The low DC resistance means high current and high inductance.

For inductance ranging from 0.15 micro H to 560 micro H, LQH32C coils have very low DC resistance.

2. The series exhibit low voltage drops and small variations in inductance with respect to temperature rise and DC current level. This makes them excellent for use as power supply line choke coils.

3. The series has excellent solder heat resistance. Both flow and reflow soldering methods can be employed.



LQH32C_11

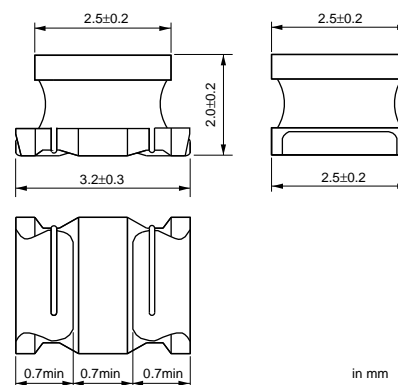

LQH32C_21

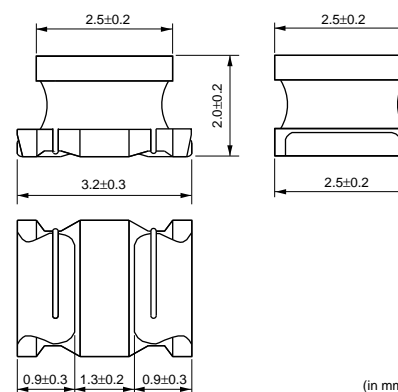

Part Number	Inductance (μH)	Test Frequency	Rated Current (mA)	DC Resistance (ohm)	Self Resonance Frequency (MHz)	EIA
LQH32CNR15M11	0.15 ±20%	1MHz	1450	0.028 ±30%	400 min.	1210
LQH32CNR27M11	0.27 ±20%	1MHz	1250	0.034 ±30%	250 min.	1210
LQH32CNR47M11	0.47 ±20%	1MHz	1100	0.042 ±30%	150 min.	1210
LQH32CN1R0M11	1 ±20%	1MHz	1000	0.06 ±30%	100 min.	1210
LQH32CN2R2M11	2.2 ±20%	1MHz	790	0.097 ±30%	64 min.	1210
LQH32CN4R7M11	4.7 ±20%	1MHz	650	0.15 ±30%	43 min.	1210
LQH32CN100K11	10 ±10%	1MHz	450	0.3 ±30%	26 min.	1210
LQH32CN1R0M21	1.0 ±20%	1MHz	800	0.06 ±30%	96 min.	1210
LQH32CN2R2M21	2.2 ±20%	1MHz	600	0.13 ±30%	64 min.	1210
LQH32CN4R7M21	4.7 ±20%	1MHz	450	0.2 ±30%	43 min.	1210
LQH32CN100K21	10 ±10%	1MHz	300	0.44 ±30%	26 min.	1210
LQH32CN220K21	22 ±10%	1MHz	250	0.71 ±30%	19 min.	1210
LQH32CN470K21	47 ±10%	1MHz	170	1.3 ±30%	15 min.	1210
LQH32CN101K21	100 ±10%	1MHz	100	3.5 ±30%	10 min.	1210
LQH32CN221K21	220 ±10%	1MHz	70	8.4 ±30%	6.8 min.	1210
LQH32CN331K21	330 ±10%	1MHz	60	10 ±30%	5.6 min.	1210
LQH32CN391K21	390 ±10%	1MHz	60	17 ±30%	5 min.	1210
LQH32CN471K21	470 ±10%	1kHz	60	19 ±30%	5 min.	1210
LQH32CN561K21	560 ±10%	1kHz	60	22 ±30%	5 min.	1210

Operating Temp. Range : -25°C to 85°C

10

■ Impedance-Frequency Characteristics

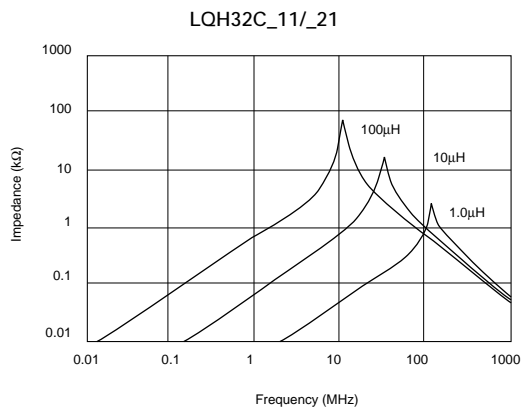

■ Inductance-Current Characteristics

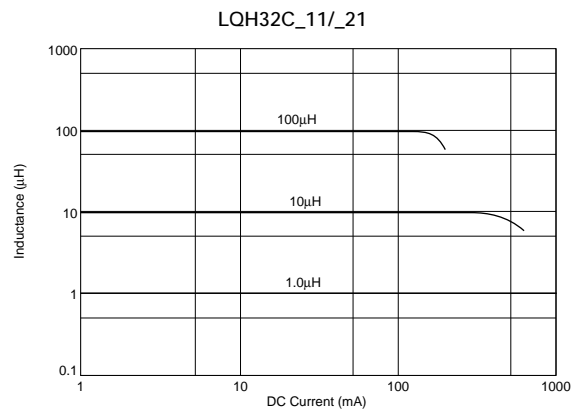

LQH32C_51 (Low Profile Type)

The LQH32C_51 series consists of miniature chip coils with low DC resistance, high current capacity, and high impedance characteristics.

These features are made possible by the development of Murata's innovative winding techniques. They are excellent for use as choke coils in DC power supply circuits.

■ Features (LQH32C_51)

1. The series have a wide inductance range of 1.0 micro H to 100 micro H.
2. The series exhibit low voltage drops and small variations in inductance with respect to temperature and DC current level. This makes them excellent for use as power supply line choke coils.
3. The series has excellent solder heat resistance. Both flow and reflow soldering methods can be employed.

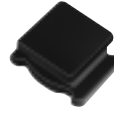

LQH32C_51

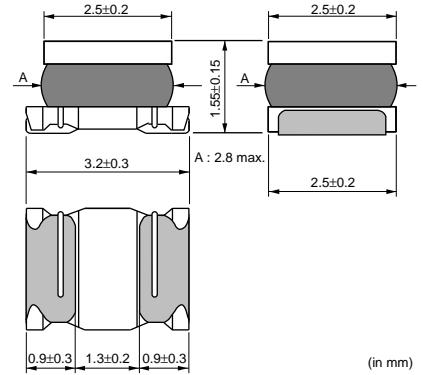

(in mm)

Part Number	Inductance (μH)	Test Frequency (MHz)	Rated Current (mA)	DC Resistance (ohm)	Self Resonance Frequency (MHz)	EIA
LQH32CN1R0M51	1.0 ±20%	1	1000	0.060 ±30%	100 min.	1210
LQH32CN2R2M51	2.2 ±20%	1	790	0.097 ±30%	64 min.	1210
LQH32CN4R7M51	4.7 ±20%	1	650	0.15 ±30%	43 min.	1210
LQH32CN100K51	10 ±10%	1	450	0.30 ±30%	26 min.	1210
LQH32CN150K51	15 ±10%	1	300	0.58 ±30%	26 min.	1210
LQH32CN220K51	22 ±10%	1	250	0.71 ±30%	19 min.	1210
LQH32CN330K51	33 ±10%	1	200	1.1 ±30%	17 min.	1210
LQH32CN470K51	47 ±10%	1	170	1.3 ±30%	15 min.	1210
LQH32CN680K51	68 ±10%	1	130	2.2 ±30%	12 min.	1210
LQH32CN101K51	100 ±10%	1	100	3.5 ±30%	10 min.	1210

Operating Temp. Range : -25°C to 85°C

10

■ Impedance-Frequency Characteristics

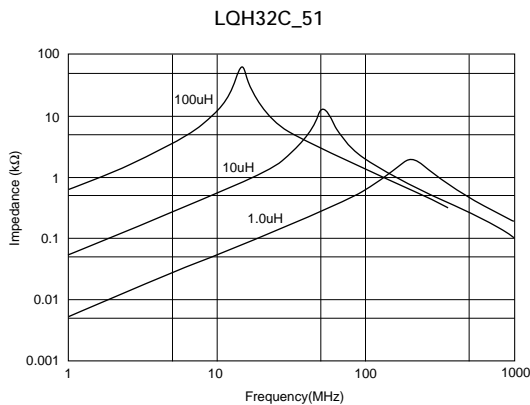

■ Inductance-Current Characteristics

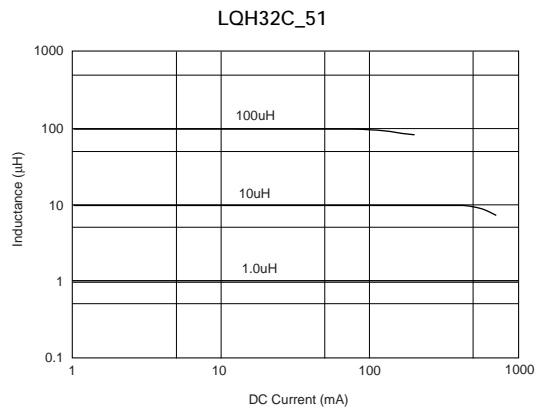

LQH43C Series

The LQH43C series consists of miniature chip inductors with low DC resistance, high current capacity, and high impedance characteristics. It is suitable for use as choke coils in DC power supply circuits.

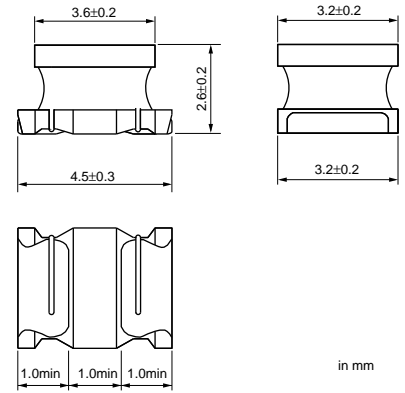

■ Features

1. The LQH43C series has an open magnetic structure. Various inductance range is available.
2. The series exhibits low voltage drops and small change in inductance with respect to temperature rise and DC current level. This makes them excellent to use as power supply line choke coils.
3. The LQH43C has miniature size 4.5mmx3.2mm and realized low height 2.8mm at max.
4. The series has excellent solder heat resistance. Both flow and reflow soldering methods can be employed.

Part Number	Inductance (μH)	Test Frequency	Rated Current (mA)	DC Resistance (ohm)	Self Resonance Frequency (MHz)	EIA
LQH43CN1R0M01	1.0 ±20%	1MHz	1080	0.08 max.	100	1812
LQH43CN1R5M01	1.5 ±20%	1MHz	1000	0.09 max.	85	1812
LQH43CN2R2M01	2.2 ±20%	1MHz	900	0.11 max.	60	1812
LQH43CN3R3M01	3.3 ±20%	1MHz	800	0.13 max.	47	1812
LQH43CN4R7M01	4.7 ±20%	1MHz	750	0.15 max.	35	1812
LQH43CN6R8M01	6.8 ±20%	1MHz	720	0.20 max.	30	1812
LQH43CN100K01	10 ±10%	1MHz	650	0.24 max.	23	1812
LQH43CN150K01	15 ±10%	1MHz	570	0.32 max.	20	1812
LQH43CN220K01	22 ±10%	1MHz	420	0.6 max.	15	1812
LQH43CN330K01	33 ±10%	1MHz	310	1.0 max.	12	1812
LQH43CN470K01	47 ±10%	1MHz	280	1.1 max.	10	1812
LQH43CN680K01	68 ±10%	1MHz	220	1.7 max.	8.4	1812
LQH43CN101K01	100 ±10%	1MHz	190	2.2 max.	6.8	1812
LQH43CN151K01	150 ±10%	1MHz	130	3.5 max.	5.5	1812
LQH43CN221K01	220 ±10%	1MHz	110	4.0 max.	4.5	1812
LQH43CN331K01	330 ±10%	1MHz	100	6.8 max.	3.6	1812
LQH43CN471K01	470 ±10%	1kHz	90	8.5 max.	3.0	1812

Operating Temp. Range : -25°C to 85°C

10

■ Impedance-Frequency Characteristics

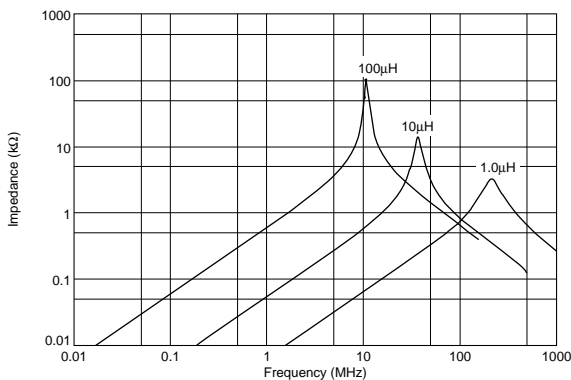

■ Inductance-Current Characteristics

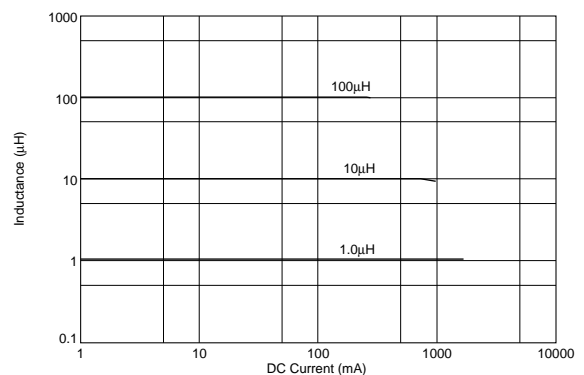

Chip Coils



for Choke Magnetic Shielded Type LQH3KS Series

■ Features

1. Low profile dimension (2.1mm max.) and small size of 1212 (3.3x3.3mm) is suitable for portable equipment.
2. The series have low DC Resistance.
3. LQH3KS series have large inductance of 560 micro H to 2200 micro H.
4. Magnetically shielded structure prevents interference occurring between peripheral components.

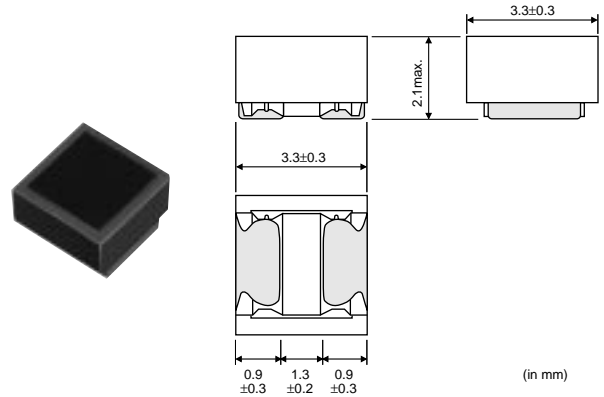

Part Number	Inductance (μH)	Test Frequency (kHz)	Rated Current (mA)	DC Resistance (ohm)	Self Resonance Frequency (MHz)	EIA
LQH3KSN561N21	560 ±30%	100	50	7.8 ±30%	3.0 min.	1212
LQH3KSN681N21	680 ±30%	100	40	9.1 ±30%	2.6 min.	1212
LQH3KSN102N21	1000 ±30%	10	30	11 ±30%	2.1 min.	1212
LQH3KSN152N21	1500 ±30%	10	25	23 ±30%	1.7 min.	1212
LQH3KSN222N21	2200 ±30%	10	20	28 ±30%	1.5 min.	1212

Operating Temp. Range : -25°C to 85°C

■ Impedance-Frequency Characteristics

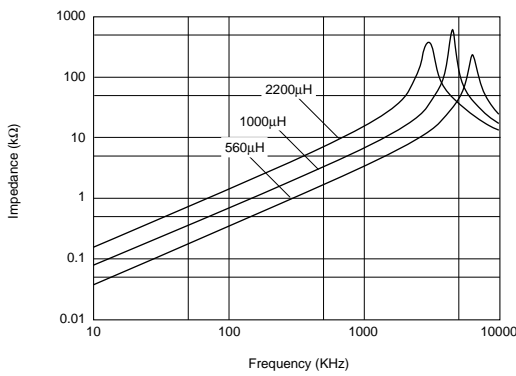

■ Inductance-Current Characteristics

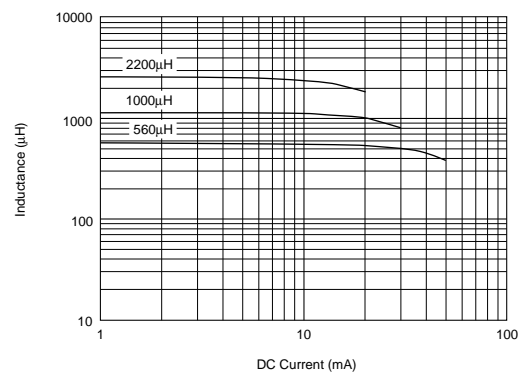

Chip Coils



for Choke Winding/Magnetic Shielded Type LQH55D/LQH66S Series

LQH55D Series

■ Features

The LQH55D series are choke inductors which have achieved low direct current resistance, large current capacity and large inductance by using high performance thick wire winding technology. They are optimum for use as choke inductors in DC/DC converters and DC power supply circuits.

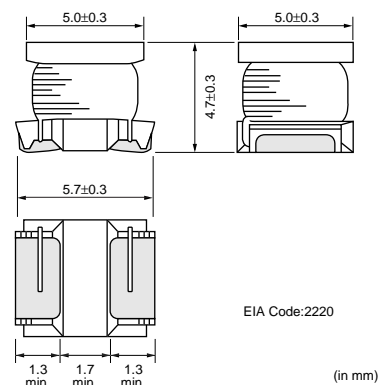

Part Number	Inductance (μH)	Test Frequency	Rated Current (mA)	DC Resistance (ohm)	Self Resonance Frequency (MHz)	EIA
LQH55DNR12M01	0.12 ±20%	1MHz	6000	0.007 ±40%	450 min.	2220
LQH55DNR27M01	0.27 ±20%	1MHz	5300	0.010 ±40%	300 min.	2220
LQH55DNR47M01	0.47 ±20%	1MHz	4800	0.013 ±40%	200 min.	2220
LQH55DN1R0M01	1.0 ±20%	1MHz	4000	0.019 ±40%	150 min.	2220
LQH55DN1R5M01	1.5 ±20%	1MHz	3700	0.022 ±40%	110 min.	2220
LQH55DN2R2M01	2.2 ±20%	1MHz	3200	0.029 ±40%	80 min.	2220
LQH55DN3R3M01	3.3 ±20%	1MHz	2900	0.036 ±40%	40 min.	2220
LQH55DN4R7M01	4.7 ±20%	1MHz	2700	0.041 ±40%	30 min.	2220
LQH55DN6R8M01	6.8 ±20%	1MHz	2000	0.074 ±40%	25 min.	2220
LQH55DN100M01	10 ±20%	1MHz	1700	0.093 ±40%	20 min.	2220
LQH55DN150M01	15 ±20%	1MHz	1400	0.15 ±40%	17 min.	2220
LQH55DN220M01	22 ±20%	1MHz	1200	0.19 ±40%	15 min.	2220
LQH55DN330M01	33 ±20%	1MHz	900	0.32 ±40%	12 min.	2220
LQH55DN470M01	47 ±20%	1MHz	800	0.40 ±40%	10 min.	2220
LQH55DN680M01	68 ±20%	1MHz	640	0.67 ±40%	7.6 min.	2220
LQH55DN101M01	100 ±20%	100kHz	560	0.86 ±40%	6.5 min.	2220
LQH55DN151M01	150 ±20%	100kHz	420	1.9 ±40%	5.0 min.	2220
LQH55DN221M01	220 ±20%	100kHz	320	2.4 ±40%	4.0 min.	2220
LQH55DN331M01	330 ±20%	100kHz	270	4.4 ±40%	3.1 min.	2220
LQH55DN471M01	470 ±20%	100kHz	240	5.4 ±40%	2.4 min.	2220
LQH55DN681M01	680 ±20%	100kHz	190	8.1 ±40%	1.9 min.	2220
LQH55DN102M01	1000 ±20%	10kHz	150	10.3 ±40%	1.7 min.	2220
LQH55DN222M01	2200 ±20%	10kHz	100	21.5 ±40%	1.2 min.	2220
LQH55DN472M01	4700 ±20%	10kHz	70	43.6 ±40%	0.8 min.	2220
LQH55DN103M01	10000 ±20%	10kHz	50	100 ±40%	0.5 min.	2220

Operating Temp. Range : -25°C to 80°C

■ Impedance-Frequency Characteristics

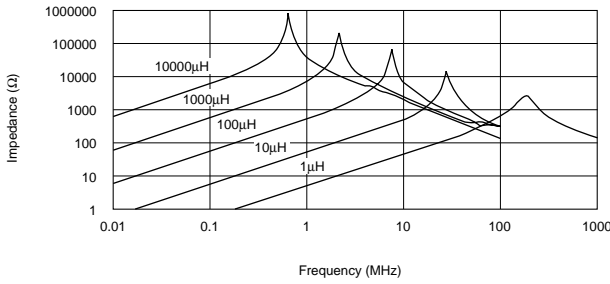

■ Inductance-Current Characteristics

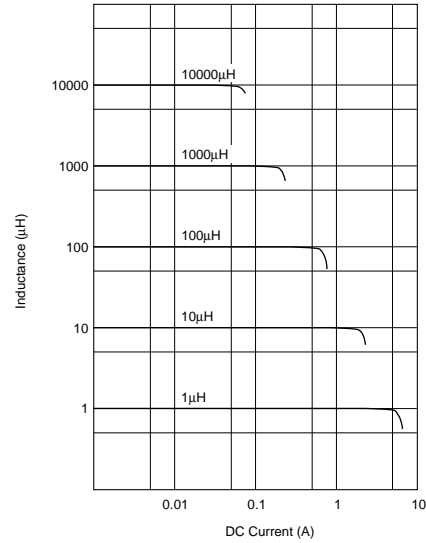

LQH66S Series

■ Features

The LQH66S series are choke inductors which have achieved low direct current resistance, large current capacity and large inductance by using high performance thick wire winding technology.

Because the LQH66S series has a magnetic shielded construction, it can be mounted in high density without interference occurring between peripheral components. They are optimum for use as choke inductors in DC/DC converters and DC power supply circuits.

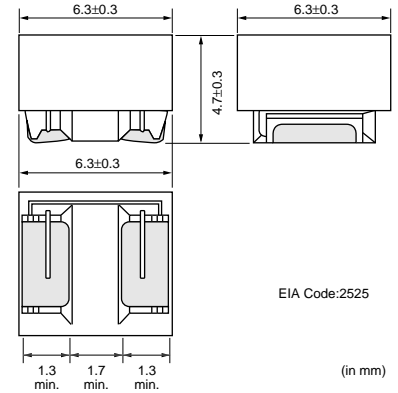

Part Number	Inductance (μH)	Test Frequency	Rated Current (mA)	DC Resistance (ohm)	Self Resonance Frequency (MHz)	EIA
LQH66SNR27M01	0.27 ±20%	1MHz	6000	0.007 ±40%	300 min.	2525
LQH66SNR68M01	0.68 ±20%	1MHz	5300	0.010 ±40%	180 min.	2525
LQH66SN1R0M01	1.0 ±20%	1MHz	4700	0.013 ±40%	150 min.	2525
LQH66SN1R5M01	1.5 ±20%	1MHz	3800	0.016 ±40%	110 min.	2525
LQH66SN2R2M01	2.2 ±20%	1MHz	3300	0.019 ±40%	80 min.	2525
LQH66SN3R3M01	3.3 ±20%	1MHz	2600	0.022 ±40%	40 min.	2525
LQH66SN4R7M01	4.7 ±20%	1MHz	2200	0.025 ±40%	30 min.	2525
LQH66SN6R8M01	6.8 ±20%	1MHz	1800	0.029 ±40%	25 min.	2525
LQH66SN100M01	10 ±20%	1MHz	1600	0.036 ±40%	20 min.	2525
LQH66SN150M01	15 ±20%	1MHz	1300	0.069 ±40%	17 min.	2525
LQH66SN220M01	22 ±20%	1MHz	1100	0.087 ±40%	15 min.	2525
LQH66SN330M01	33 ±20%	1MHz	860	0.14 ±40%	12 min.	2525
LQH66SN470M01	47 ±20%	1MHz	760	0.17 ±40%	10 min.	2525
LQH66SN680M01	68 ±20%	1MHz	600	0.29 ±40%	7.6 min.	2525
LQH66SN101M01	100 ±20%	100kHz	520	0.36 ±40%	6.5 min.	2525
LQH66SN151M01	150 ±20%	100kHz	420	0.63 ±40%	5.0 min.	2525
LQH66SN221M01	220 ±20%	100kHz	350	0.79 ±40%	4.0 min.	2525
LQH66SN331M01	330 ±20%	100kHz	280	1.8 ±40%	3.2 min.	2525
LQH66SN471M01	470 ±20%	100kHz	240	2.2 ±40%	2.5 min.	2525
LQH66SN681M01	680 ±20%	100kHz	200	3.9 ±40%	2.0 min.	2525
LQH66SN102M01	1000 ±20%	10kHz	160	4.9 ±40%	1.7 min.	2525
LQH66SN222M01	2200 ±20%	10kHz	100	9.4 ±40%	1.2 min.	2525
LQH66SN472M01	4700 ±20%	10kHz	70	19.5 ±40%	0.8 min.	2525

Continued on the following page.

Continued from the preceding page.

Part Number	Inductance (μH)	Test Frequency	Rated Current (mA)	DC Resistance (ohm)	Self Resonance Frequency (MHz)	EIA
LQH66SN103M01	10000 ±20%	10kHz	50	39.7 ±40%	0.5 min.	2525

Operating Temp. Range : -25°C to 80°C

■ Impedance-Frequency Characteristics

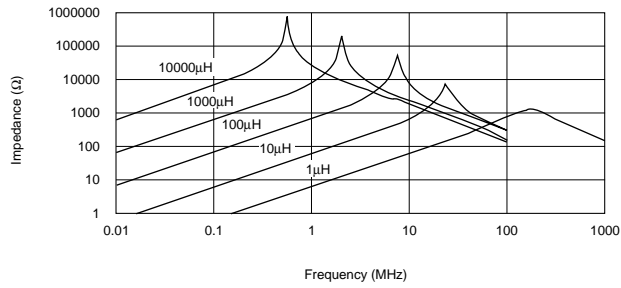

■ Inductance-Current Characteristics

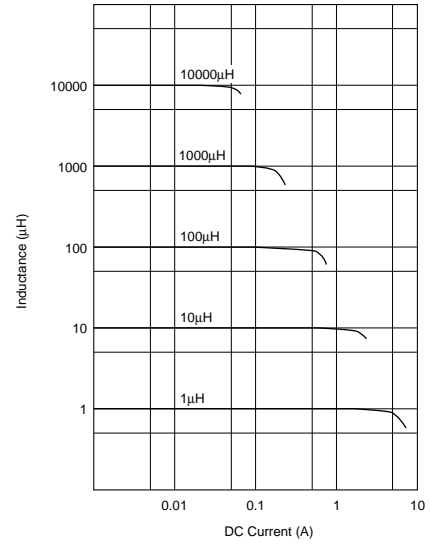

Monolithic And Film Type Notice(Soldering and Mounting)

1. STANDARD LAND DIMENSIONS

A high Q value is achieved when the PCB electrode land pattern is designed so that it does not project beyond the chip coil electrode.

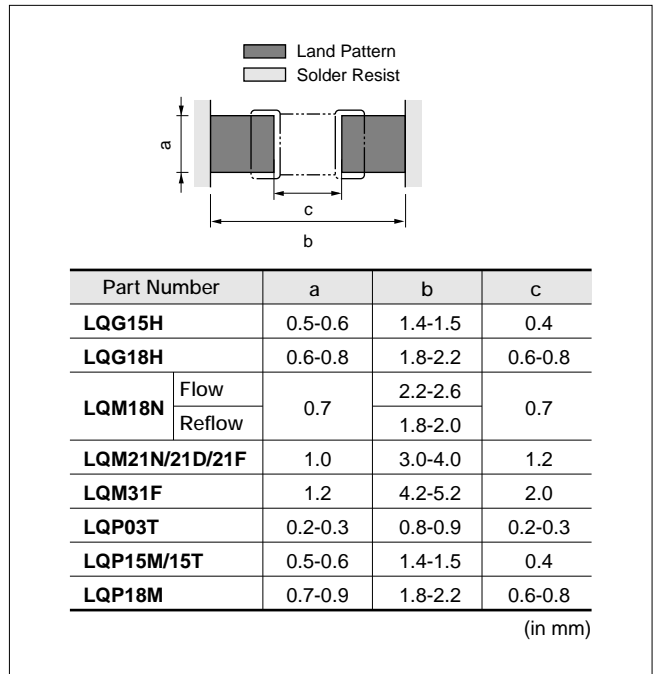

2. STANDARD SOLDERING CONDITIONS

1) Soldering method

Chip coils can be flow or reflow soldered. Please contact Murata regarding other soldering methods. The volume of solder can cause minor fluctuations in inductance value. Therefore, carefully control the amount of solder when soldering the LQG15H/18H, LQP03T/15M/15T/18M series.

2) Soldering Temperature and Time

Solder within the temperature and time combinations indicated by the slanted lines in the following graphs. If soldering is repeated, please note that the allowed time is the accumulated time.

Solder : Use H60A, H63A(JIS Z 3282) or equivalent.

Use solder paste equivalent to H60A for LQP03T/15M/15T/18M and LQG15H/18H.

Flux : Use rosin-based flux, but not strongly acidic flux. (with chlorine content exceeding 0.2wt%)
Do not use water-soluble flux.

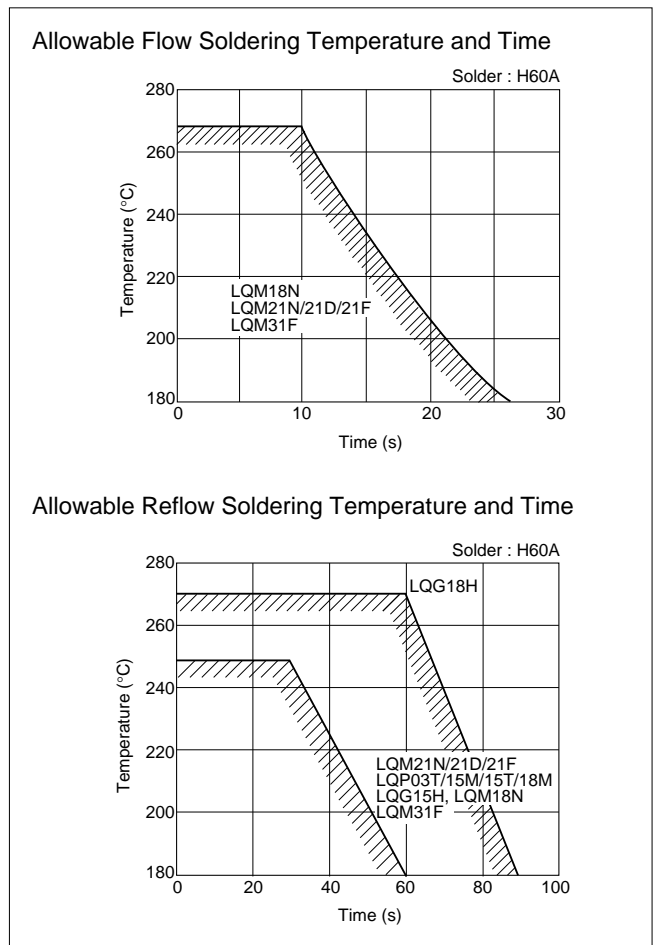

Continued on the following page.

Monolithic And Film Type Notice(Soldering and Mounting)

 Continued from the preceding page.

3) Standard Soldering Conditions

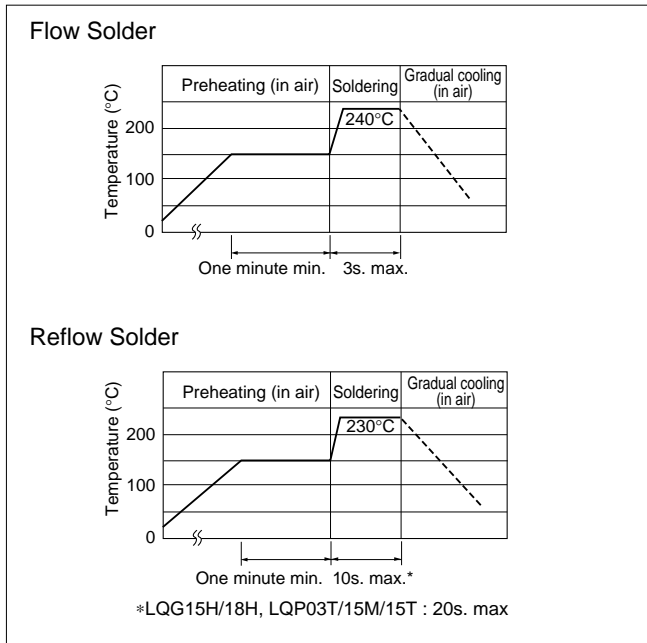

4) Reworking with Soldering Iron

Preheating at 150°C for 1 minute is required. Do not directly touch the ceramic element with the tip of the soldering iron. The reworking soldering conditions are as follows.

- Soldering iron power output : 30W Max.
- Temperature of soldering iron tip : 280°C
- Diameter of soldering iron end : 3.0mm Max.
- Soldering time : within 3 second

3. MOUNTING INSTRUCTIONS

1) Land Pattern Dimensions

Large lands reduce Q of the mounted chip. Also, large protruding land areas (bordered by lines having dimensions 'c' and 'd' shown below) cause floating and electrode cracks.

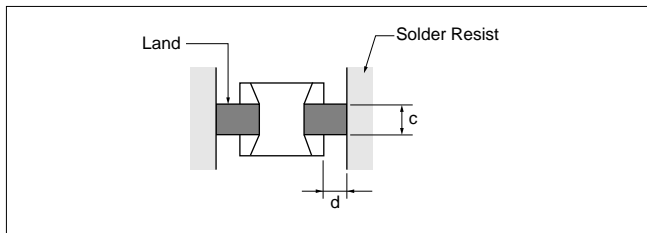

2) Magnetic Coupling

Since some chip coils are constructed like an open magnetic circuit, narrow spacing between coils may cause magnetic coupling. The LQG and LQM series have a magnetically shielded structure. The structure makes their coupling coefficient smaller than that of conventional chip coils.

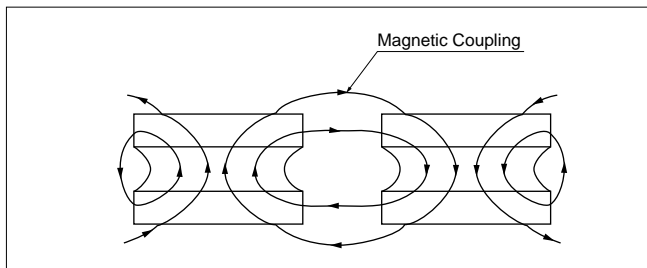

Continued on the following page. 

Monolithic And Film Type Notice(Soldering and Mounting)

 Continued from the preceding page.

3) PCB Warping

P.C.B. shall be designed so that products are not subjected to the mechanical stress due to warping the board.

Products shall be located in the sideways direction (Length: $a < b$) to the mechanical stress.

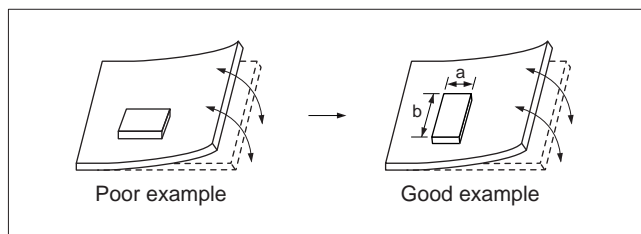

4) Amount of Solder Paste

Excessive solder causes electrode corrosion, while insufficient solder causes low electrode bonding strength.

Adjust the amount of solder paste so that solder is applied as shown in the right.

Standard thickness of solder paste : 100 to 150 μ m

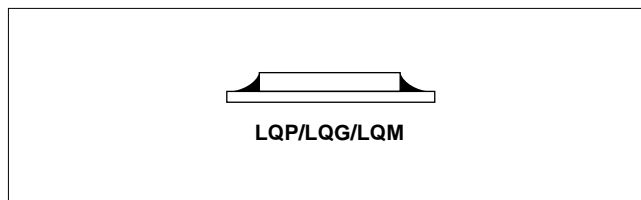

5) Amount of Adhesive

If too much adhesive is applied, then it may overflow into the land or termination areas and yield poor solderability.

In contrast, if insufficient adhesive is applied, or if the adhesive is not sufficiently hardened, then the chip may become detached during flow soldering. Apply the adhesive in accordance with the following conditions.

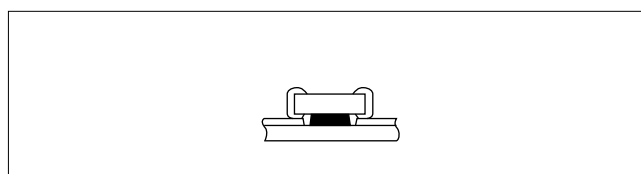

Part Number	Typical Application Amount (in:mg)		
	MR-8153RA	NF-3000	UVS-50R-2
LQM18N	0.05-0.06	0.06-0.07	0.06-0.07
LQM21N/21D/21F	0.15-0.20	0.20-0.25	0.20-0.25
LQM31F	0.20-0.25	0.25-0.30	0.25-0.30

Winding Type Notice(Soldering and Mounting)

1. STANDARD LAND DIMENSIONS

A high Q value is achieved when the PCB electrode land pattern is designed so that it does not project beyond the chip coil electrode.

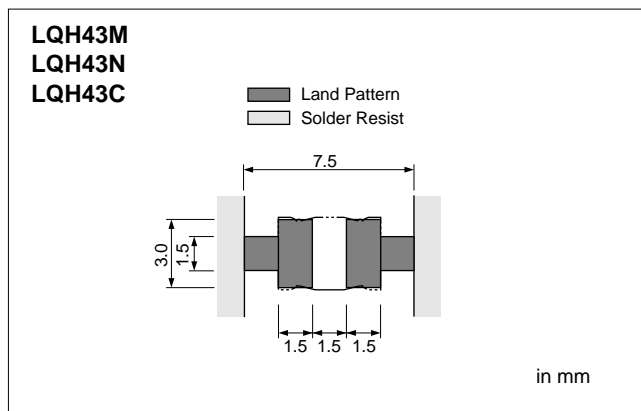
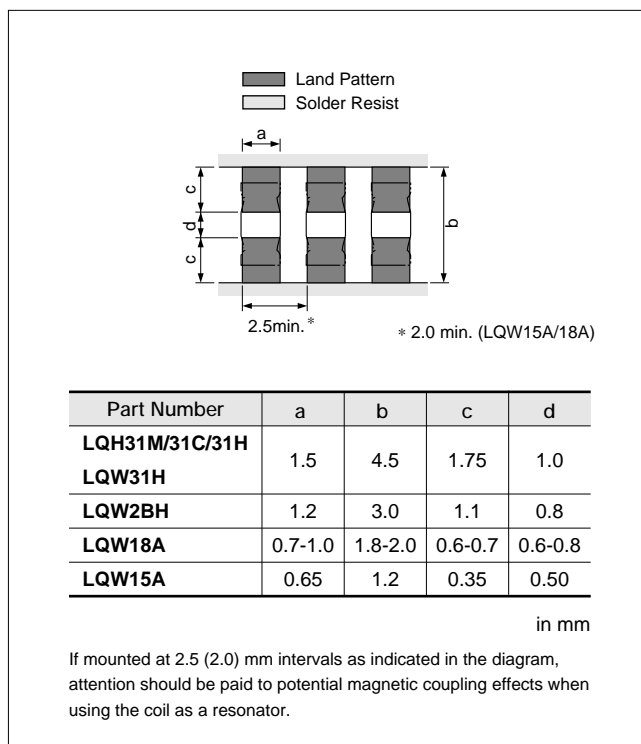

Continued on the following page.

Winding Type Notice(Soldering and Mounting)

Continued from the preceding page.

2. STANDARD SOLDERING CONDITIONS

1) Soldering method

Chip coils can be flow or reflow soldered.
 Please contact Murata regarding other soldering methods.
 Reflow soldering should be applied for LQW15A/18A.

2) Soldering Temperature and Time

Solder within the temperature and time combinations indicated by the slanted lines in the following graphs. If soldering is repeated, please note that the allowed time is the accumulated time.

Solder : Use H60A, H63A(JIS Z 3282) or equivalent.

Flux : Use rosin-based flux, but not strongly acidic flux.
 (with chlorine content exceeding 0.2wt%)
 Do not use water-soluble flux.

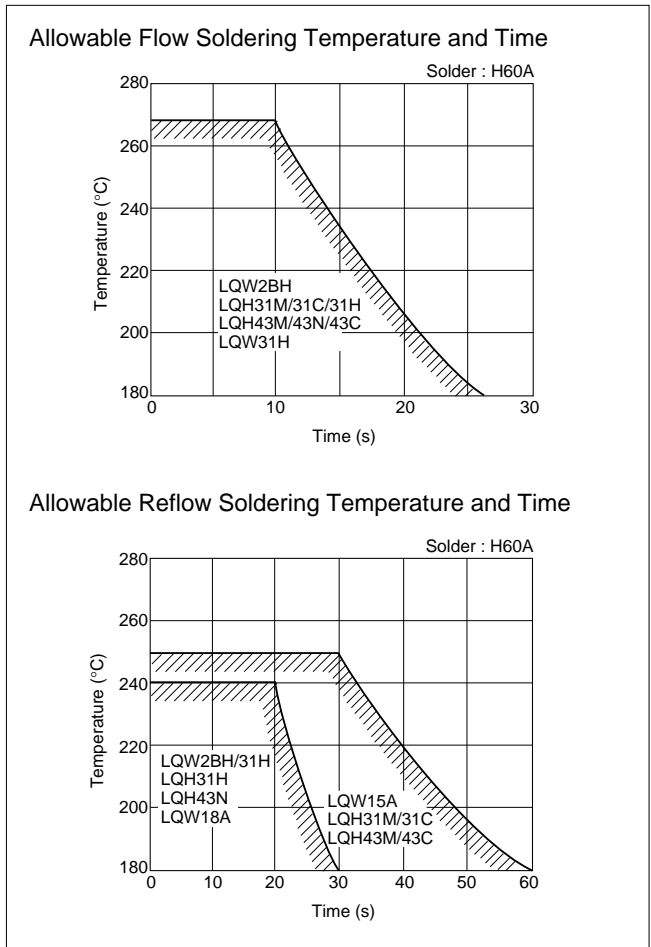

3) Standard Soldering Conditions

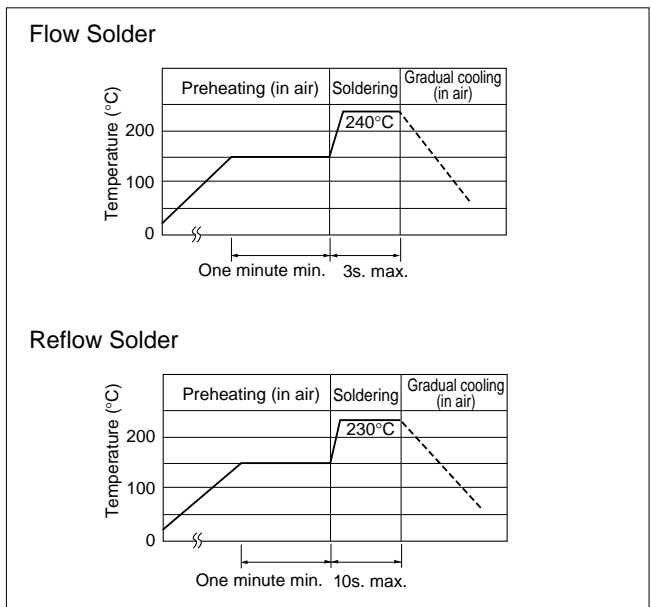

Continued on the following page.

Winding Type Notice(Soldering and Mounting)

 Continued from the preceding page.

4) Reworking with Soldering Iron

Preheating at 150°C for 1 minute is required. Do not directly touch the ceramic element with the tip of the soldering iron. The reworking soldering conditions are as follows.

- Soldering iron power output : 30W Max.
- Temperature of soldering iron tip : 280°C
- Diameter of soldering iron end : 3.0mm Max.
- Soldering time : within 3 second

3. MOUNTING INSTRUCTIONS

1) Land Pattern Dimensions

Large lands reduce Q of the mounted chip. Also, large protruding land areas (bordered by lines having dimensions 'c' and 'd' shown below) cause floating and electrode cracks.

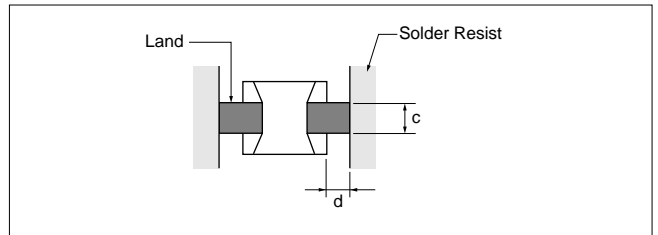

2) Magnetic Coupling

Since some chip coils are constructed like an open magnetic circuit, narrow spacing between coils may cause magnetic coupling. The LQH series have a magnetically shielded structure. The structure makes their coupling coefficient smaller than that of conventional chip coils.

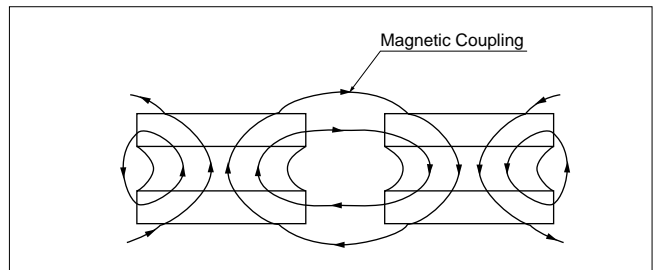

3) PCB Warping

P.C.B. shall be designed so that products are not subjected to the mechanical stress due to warping the board. Products shall be located in the sideways direction (Length:a<b) to the mechanical stress.

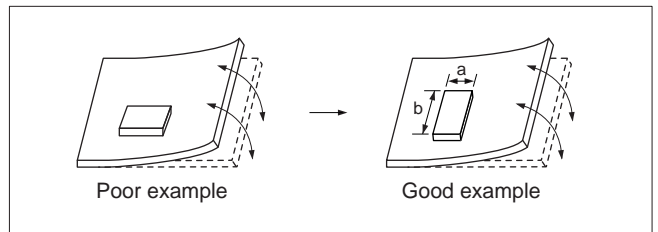

4) Amount of Solder Paste

Excessive solder causes electrode corrosion, while insufficient solder causes low electrode bonding strength. Adjust the amount of solder paste so that solder is applied as shown in the right. Standard thickness of solder paste: 200 to 300µm (LQW15A/18A : 100 to 150µm)

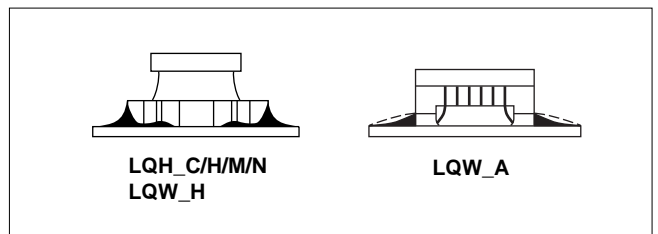

Continued on the following page. 

Winding Type Notice(Soldering and Mounting)

 Continued from the preceding page.

5) Amount of Adhesive

If too much adhesive is applied, then it may overflow into the land or termination areas and yield poor solderability. In contrast, if insufficient adhesive is applied, or if the adhesive is not sufficiently hardened, then the chip may become detached during flow soldering. Apply the adhesive in accordance with the following conditions.

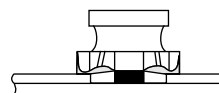

Part Number	Typical Application Amount (in:mg)		
	MR-8153RA	NF-3000	UVS-50R-2
LQW2BH	0.16-0.18	0.20-0.25	0.21-0.23
LQH31M/31C/31H LQW31H	0.18-0.20	0.20-0.25	0.20-0.25
LQH43M(N) LQH43C	0.45-0.50	0.60-0.80	0.60-0.80

Winding And Magnetic Shielded Type Notice(Soldering and Mounting)

1. STANDARD LAND DIMENSIONS

A high Q value is achieved when the PCB electrode land pattern is designed so that it does not project beyond the chip coil electrode.

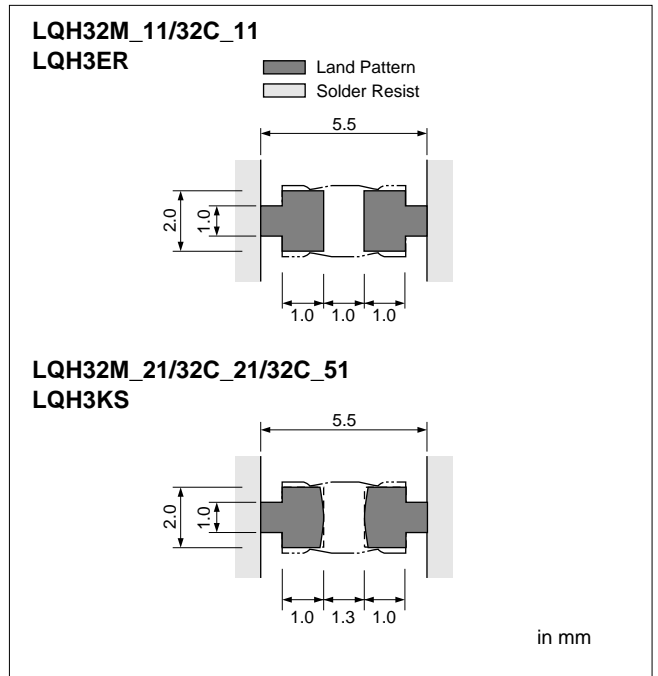

2. STANDARD SOLDERING CONDITIONS

1) Soldering method

Chip coils can be flow or reflow soldered.
Please contact Murata regarding other soldering methods.
Reflow soldering should be applied for LQH3ER/3KS.

2) Soldering Temperature and Time

Solder within the temperature and time combinations indicated by the slanted lines in the following graphs. If soldering is repeated, please note that the allowed time is the accumulated time.

Solder : Use H60A,H63A(JIS Z 3282) or equivalent.

Flux : Use rosin-based flux, but not strongly acidic flux.
(with chlorine content exceeding 0.2wt%)
Do not use water-soluble flux.

Allowable Flow Soldering Temperature and Time

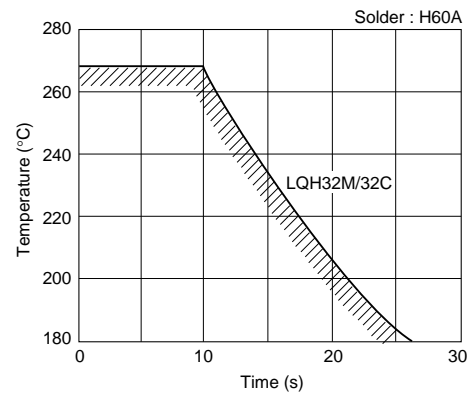

Allowable Reflow Soldering Temperature and Time

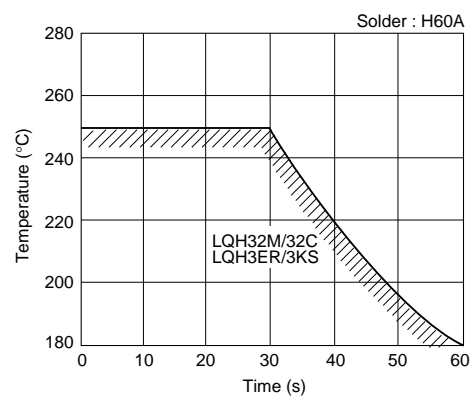

Continued on the following page.

Winding And Magnetic Shielded Type Notice(Soldering and Mounting)

Continued from the preceding page.

3) Standard Soldering Conditions

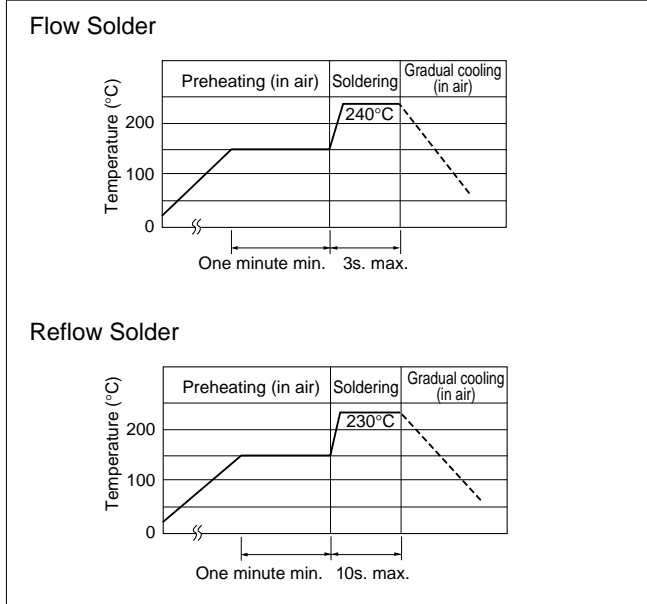

4) Reworking with Soldering Iron

Preheating at 150°C for 1 minute is required. Do not directly touch the ceramic element with the tip of the soldering iron. The reworking soldering conditions are as follows.

- Soldering iron power output : 30W Max.
- Temperature of soldering iron tip : 280°C
- Diameter of soldering iron end : 3.0mm Max.
- Soldering time : within 3 second

3. MOUNTING INSTRUCTIONS

1) Land Pattern Dimensions

Large lands reduce Q of the mounted chip. Also, large protruding land areas (bordered by lines having dimensions 'c' and 'd' shown below) cause floating and electrode cracks.

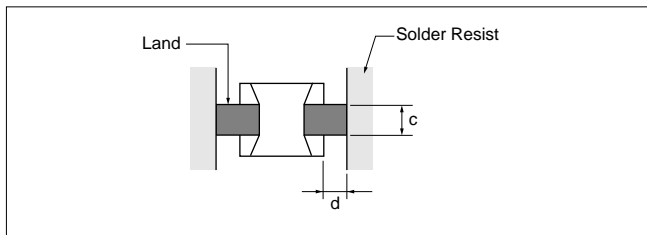

2) Magnetic Coupling

Since some chip coils are constructed like an open magnetic circuit, narrow spacing between coils may cause magnetic coupling.

The LQH_R/S, LQG, LQM series have a magnetically shielded structure. The structure makes their coupling coefficient smaller than that of conventional chip coils. In particular, the LQH3ER series has a very small coupling coefficient.

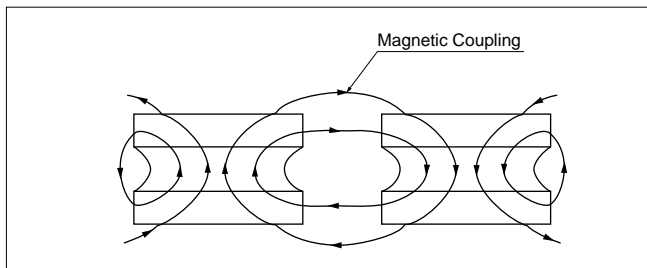

Continued on the following page.

Winding And Magnetic Shielded Type Notice(Soldering and Mounting)

 Continued from the preceding page.

3) PCB Warping

P.C.B. shall be designed so that products are not subjected to the mechanical stress due to warping the board.

Products shall be located in the sideways direction (Length: $a < b$) to the mechanical stress.

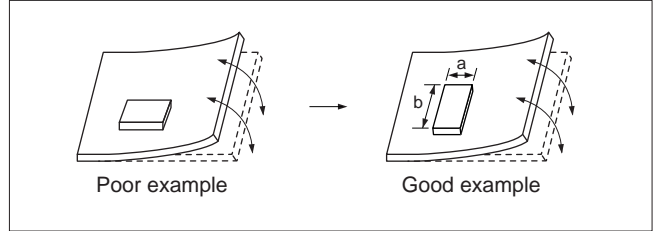

4) Amount of Solder Paste

Excessive solder causes electrode corrosion, while insufficient solder causes low electrode bonding strength. Adjust the amount of solder paste so that solder is applied as shown in the right.

Standard thickness of solder paste: 200 to 300 μ m

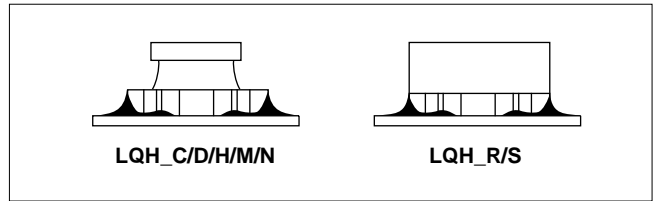

5) Amount of Adhesive

If too much adhesive is applied, then it may overflow into the land or termination areas and yield poor solderability. In contrast, if insufficient adhesive is applied, or if the adhesive is not sufficiently hardened, then the chip may become detached during flow soldering. Apply the adhesive in accordance with the following conditions.

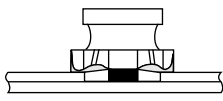

Part Number	Typical Application Amount (in:mg)		
	MR-8153RA	NF-3000	UVS-50R-2
LQH32M/32C	0.20-0.23	0.27-0.35	0.27-0.35

Large-current Type Notice(Soldering and Mounting)

1. STANDARD LAND DIMENSIONS

A high Q value is achieved when the PCB electrode land pattern is designed so that it does not project beyond the chip coil electrode.

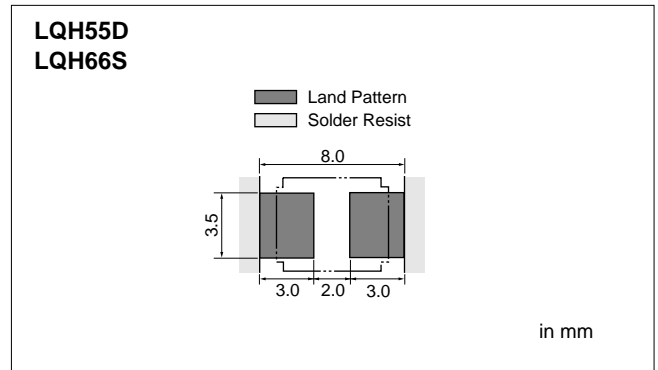

2. STANDARD SOLDERING CONDITIONS

1) Soldering method

Reflow soldering should be applied for LQH55D/66S.

2) Soldering Temperature and Time

Solder within the temperature and time combinations indicated by the slanted lines in the following graphs. If soldering is repeated, please note that the allowed time is the accumulated time.

Solder : Use H60A,H63A(JIS Z 3282) or equivalent.

Flux : Use rosin-based flux, but not strongly acidic flux.
(with chlorine content exceeding 0.2wt%)
Do not use water-soluble flux.

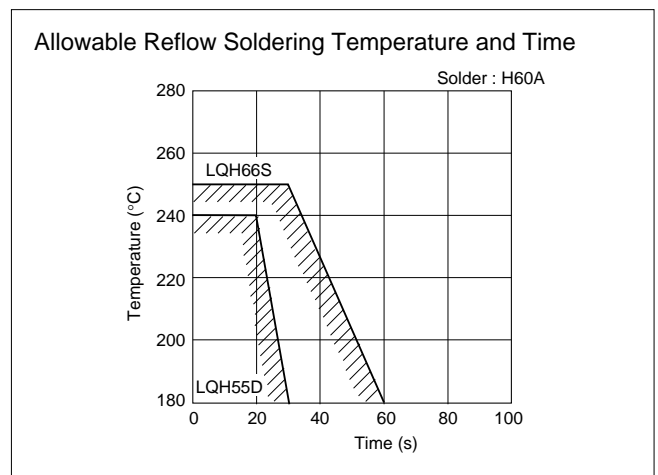

3) Standard Soldering Conditions

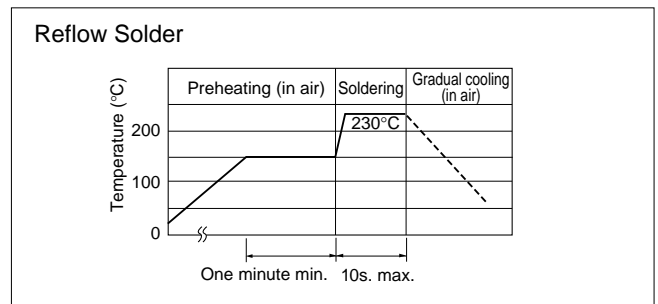

4) Reworking with Soldering Iron

Preheating at 150°C for 1 minute is required. Do not directly touch the ceramic element with the tip of the soldering iron. The reworking soldering conditions are as follows.

- Soldering iron power output : 30W Max.
- Temperature of soldering iron tip : 280°C
- Diameter of soldering iron end : 3.0mm Max.
- Soldering time : within 3 second

Continued on the following page.

Large-current Type Notice(Soldering and Mounting)

 Continued from the preceding page.

3. MOUNTING INSTRUCTIONS

1) Land Pattern Dimensions

Large lands reduce Q of the mounted chip. Also, large protruding land areas (bordered by lines having dimensions 'c' and 'd' shown bellow) cause floating and electrode cracks.

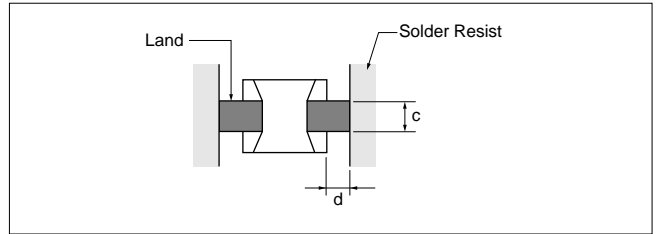

2) Magnetic Coupling

Since some chip coils are constructed like an open magnetic circuit, narrow spacing between coils may cause magnetic coupling. The LQH_S series have a magnetically shielded structure. The structure makes their coupling coefficient smaller than that of conventional chip coils.

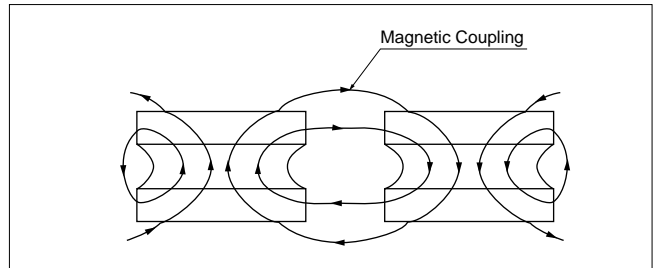

3) PCB Warping

P.C.B. shall be designed so that products are not subjected to the mechanical stress due to warping the board. Products shall be located in the sideways direction (Length: $a < b$) to the mechanical stress.

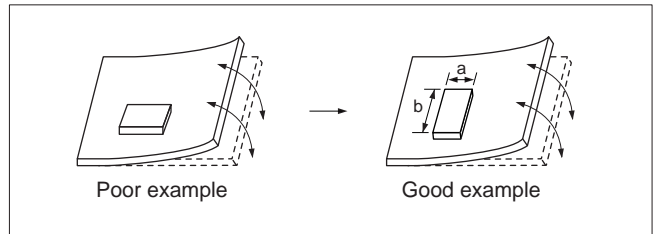

4) Amount of Solder Paste

Excessive solder causes electrode corrosion, while insufficient solder causes low electrode bonding strength. Adjust the amount of solder paste so that solder is applied as shown bellow. Standard thickness of solder paste: 200 to 300 μ m

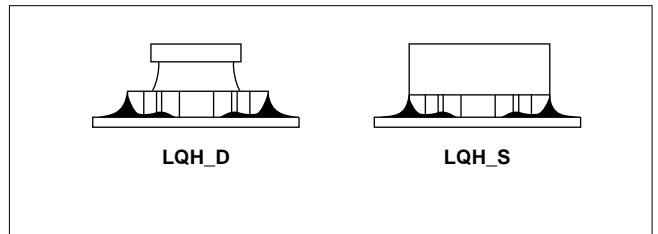

Notice

■ Notice (Storage and Operating Conditions)

< Operating Environment >

Do not use products in chemical atmosphere such as chlorine gas, acid or sulfide gas.

< Storage Requirements >

1. Storage Period

Products should be used within 12 months reckon from the date of our out-going inspection.

Solderability should be verified if this period is exceeded. (LQH3ER/3KS series should be used within 6 months.)

2. Storage conditions

- a) Store products in a warehouse in compliance with the following conditions :
- Temperature : -10 to 40C.

Humidity : 30 to 70% (relative humidity)

Do not subject products to rapid changes in temperature and humidity.

Do not store them in chemical atmosphere such as one containing sulfurous acid gas or alkaline gas.

This will prevent electrode oxidation which causes poor solderability and possible corrosion of coils.

- b) Do not store products in bulk packaging to prevent collision among coils which causes core chipping and wire breakage.
- c) Store products on pallets to protect from humidity, dust, etc.
- d) Avoid heat shock, vibration, direct sunlight, etc.

■ Notice (Soldering and Mounting)

< Cleaning >

The following conditions should be observed when cleaning chip coils.

1. Cleaning Temperature : 60C. max. (40C. max. for alcohol cleaning agents)

2. Ultrasonic

Output : 20W/l max.

Duration : 5 minutes max.

Frequency : 28kHz to 40kHz

Care should be taken not to cause resonance of the PCB and mounted products.

3. Cleaning agent

The following cleaning agents have been tested on individual components. Evaluation in complete assembly should be done prior to production.

- (1) Alcohol cleaning agents
Isopropyl alcohol (IPA)

(2) Aqueous cleaning agents

•Surface active agent (Clean Thru 750H)

•High grade alcohol (Pine Alpha ST-100S)

•Hydrocarbon (Techno Cleaner 375)

•Alkaline Saponifier (Aqua Cleaner 210SEI-cleaner should be diluted to 15% using deionized water.)

LQH_R/S series : Aqueous agents should not be used because they may cause quality deterioration.

LQH series : Surface active agent and high grade alcohol can be used.

4. Ensure that flux residue is completely removed.

Component should be thoroughly dried after aqueous agents have been removed with deionized water.

For additional cleaning methods, please contact Murata.

Notice

■ Notice (Handling)

This item is designed to have sufficient strength, but handle with care not to make it chipped or broken due to its ceramic structure.

LQW_A series

- Sharp material, such as tweezers, shall not touch to the winding portion to prevent the breaking of wire.
- Do not give excessive Mechanical shock should not be applied to the products mounted on the board to prevent thebreaking of the core.
- In some mounting machines, when picking up components, support pin pushes up the components from the bottom of base tape. In this case, please remove the support pin. The support pin may damage the components and break wire.

LQH_C/D/H/M/N, LQW_H series

- Sharp material, such as tweezers, shall not touch to the winding portion to prevent the breaking of wire.
- Do not give excessive Mechanical shock should not be applied to the products mounted on the board to prevent thebreaking of the core.

LQP series

- The pattern of the chip coil is covered with the protection film. But the handling the chip coil shall be taken care so that the chip coil would

not be damaged with the pick-up nozzle, the sharp substance and so on.

LQM series

- There is possibility that the inductance value change due to magnetism. Do not use a magnet or tweezers with magnetism when chip coil are handled. (The tip of the tweezers should be molded with resin or pottery.)

< Handling >

1. Avoid applying excessive stress to products to prevent damage.
2. Do not touch winding with sharp objects such as tweezers to prevent wire breakage.
3. Do not apply excessive force to products mounted on boards to prevent core breakage.

< Transportations >

Do not apply excessive vibration or mechanical shock to products.

< Resin Coating >

When coating products with resin, the relatively high resin curing stress may change inductance values.

For exterior coating, select resin carefully so that electrical and mechanical performance of the product is not affected.

Packaging

Minimum Quantity and 8mm Width Taping Dimension

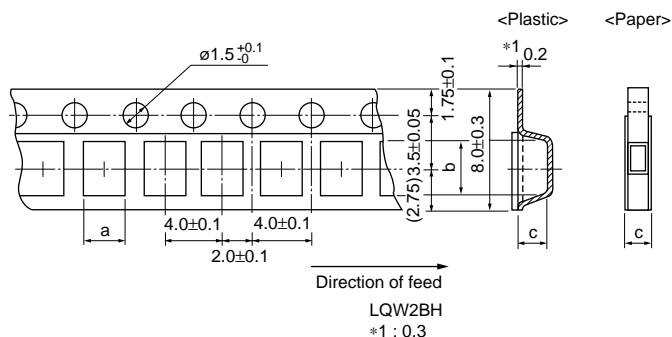

Paper Tape

Part Number	Dimensions (in mm)			Minimum QTY. (pcs.)		
	a	b	c	ø180mm reel	ø330mm reel	Bulk
LQM21N (0.1-2.2μH)	1.45	2.25	1.1	4000	10000	1000
LQM21D (1-10μH)						
LQM21F (1-2.2μH)						
LQG18H	1.05	1.85				
LQM18N						
LQW18A	1.00	1.80				500
LQW18AN_10	1.1	1.90				

Plastic Tape

Part Number	Dimensions (in mm)			Minimum QTY. (pcs.)		
	a	b	c	ø180mm reel	ø330mm reel	Bulk
LQM21N (2.7-4.7μH)	1.45	2.25	1.3	4000	10000	1000
LQM21D (22-47μH)						
LQM21F (4.7-47μH)						
LQM31F	1.9	3.5	1.3	3000	7500	-
LQH31M/31C/31H, LQW31H	1.9	3.6	2.0	2000		
LQW2BH	1.75	2.3				
LQH32M/LQH32CN_11, 21	2.9	3.6	2.1			
LQH32CN_51			1.7			

(in mm)

Continued on the following page.

Packaging

Continued from the preceding page.

Minimum Quantity and 8mm Width Taping Dimension

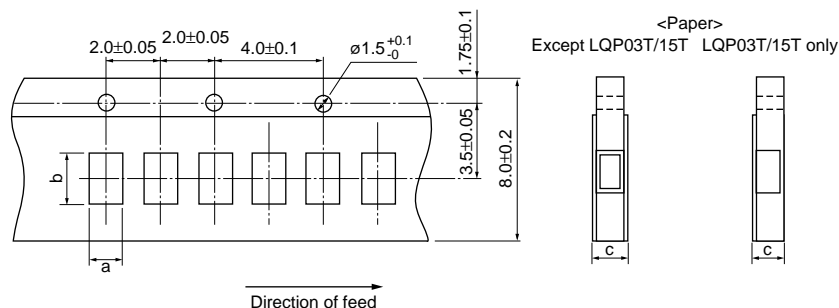

Paper Tape

Part Number	Dimensions (in mm)			Minimum QTY. (pcs.)		
	a	b	c	$\phi 180$ mm reel	$\phi 330$ mm reel	Bulk
LQG15H	0.62	1.12	1.0 max.	10000	50000	1000
LQP03T	0.38	0.68			-	
LQP15M	0.70	1.20			-	500
LQP15T	0.62	1.12				
LQP18M	1.19	2.0				
LQW15A	0.70	1.20	0.8 max.			

(in mm)

Minimum Quantity And 12mm Width Plastic Taping Dimension

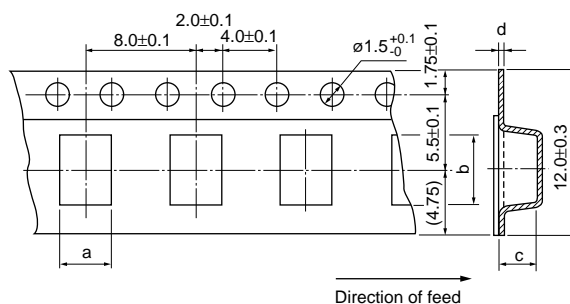

Part Number	Dimensions (in mm)				Minimum QTY. (pcs.)	
	a	b	c	d	$\phi 180$ mm reel	$\phi 330$ mm reel
LQH3ER	3.9	3.7	1.9	0.3	1000	-
LQH3KS						4000
LQH43M(N)	3.6	4.9	2.7		500	2500
LQH43C						-
LQH55D	5.4	6.1	5.0	0.4	350	1500
LQH66S	6.7	6.7	5.6			-

(in mm)

Design Kits



●EKLMOG15A (High-frequency Monolithic Type)

No.	Part Number	Quantity (pcs.)	Inductance		Q min.	DC Resistance (Ω) max.	Rated Current (mA)
			Nominal	Tolerance			
1	LQG15HN1N0S02	20	1.0nH	±0.3nH	8	0.10	200
2	LQG15HN1N1S02	20	1.1nH	±0.3nH	8	0.10	200
3	LQG15HN1N2S02	20	1.2nH	±0.3nH	8	0.10	200
4	LQG15HN1N3S02	20	1.3nH	±0.3nH	8	0.10	200
5	LQG15HN1N5S02	20	1.5nH	±0.3nH	8	0.10	200
6	LQG15HN1N6S02	20	1.6nH	±0.3nH	8	0.10	200
7	LQG15HN1N8S02	20	1.8nH	±0.3nH	8	0.10	200
8	LQG15HN2N0S02	20	2.0nH	±0.3nH	8	0.15	200
9	LQG15HN2N2S02	20	2.2nH	±0.3nH	8	0.15	200
10	LQG15HN2N4S02	20	2.4nH	±0.3nH	8	0.17	200
11	LQG15HN2N7S02	20	2.7nH	±0.3nH	8	0.17	200
12	LQG15HN3N0S02	20	3.0nH	±0.3nH	8	0.19	200
13	LQG15HN3N3S02	20	3.3nH	±0.3nH	8	0.19	200
14	LQG15HN3N6S02	20	3.6nH	±0.3nH	8	0.19	200
15	LQG15HN3N9S02	20	3.9nH	±0.3nH	8	0.19	200
16	LQG15HN4N3S02	20	4.3nH	±0.3nH	8	0.23	200
17	LQG15HN4N7S02	20	4.7nH	±0.3nH	8	0.23	200
18	LQG15HN5N1S02	20	5.1nH	±0.3nH	8	0.26	200
19	LQG15HN5N6S02	20	5.6nH	±0.3nH	8	0.26	200
20	LQG15HN6N2S02	20	6.2nH	±0.3nH	8	0.29	200
21	LQG15HN6N8J02	20	6.8nH	±5%	8	0.29	200
22	LQG15HN7N5J02	20	7.5nH	±5%	8	0.33	200
23	LQG15HN8N2J02	20	8.2nH	±5%	8	0.33	200
24	LQG15HN9N1J02	20	9.1nH	±5%	8	0.35	200
25	LQG15HN10NJ02	20	10nH	±5%	8	0.35	200
26	LQG15HN12NJ02	20	12nH	±5%	8	0.41	200
27	LQG15HN15NJ02	20	15nH	±5%	8	0.46	200
28	LQG15HN18NJ02	20	18nH	±5%	8	0.51	200
29	LQG15HN22NJ02	20	22nH	±5%	8	0.58	200
30	LQG15HN27NJ02	20	27nH	±5%	8	0.67	200
31	LQG15HN33NJ02	20	33nH	±5%	8	0.67	200
32	LQG15HN39NJ02	20	39nH	±5%	8	1.06	150
33	LQG15HN47NJ02	20	47nH	±5%	8	1.15	150
34	LQG15HN56NJ02	20	56nH	±5%	8	1.20	150
35	LQG15HN68NJ02	20	68nH	±5%	8	1.25	150
36	LQG15HN82NJ02	20	82nH	±5%	8	1.60	150
37	LQG15HNR10J02	20	100nH	±5%	8	1.60	150
38	LQG15HNR12J02	20	120nH	±5%	8	1.60	150

Design Kits

●EKLMOG18A (High-frequency Monolithic Type)

No.	Part Number	Quantity (pcs.)	Inductance		Q min.	DC Resistance (Ω) max.	Rated Current (mA)
			Nominal	Tolerance			
1	LQG18HN1N2S00	20	1.2nH	±0.3nH	12	0.10	300
2	LQG18HN1N5S00	20	1.5nH	±0.3nH	12	0.10	300
3	LQG18HN1N8S00	20	1.8nH	±0.3nH	12	0.10	300
4	LQG18HN2N2S00	20	2.2nH	±0.3nH	12	0.10	300
5	LQG18HN2N7S00	20	2.7nH	±0.3nH	12	0.15	300
6	LQG18HN3N3S00	20	3.3nH	±0.3nH	12	0.15	300
7	LQG18HN3N9S00	20	3.9nH	±0.3nH	12	0.15	300
8	LQG18HN4N7S00	20	4.7nH	±0.3nH	12	0.20	300
9	LQG18HN5N6S00	20	5.6nH	±0.3nH	12	0.20	300
10	LQG18HN6N8J00	20	6.8nH	±5%	12	0.25	300
11	LQG18HN8N2J00	20	8.2nH	±5%	12	0.25	300
12	LQG18HN10NJ00	20	10nH	±5%	12	0.30	300
13	LQG18HN12NJ00	20	12nH	±5%	12	0.35	300
14	LQG18HN15NJ00	20	15nH	±5%	12	0.40	300
15	LQG18HN18NJ00	20	18nH	±5%	12	0.45	300
16	LQG18HN22NJ00	20	22nH	±5%	12	0.50	300
17	LQG18HN27NJ00	20	27nH	±5%	12	0.55	300
18	LQG18HN33NJ00	20	33nH	±5%	12	0.60	300
19	LQG18HN39NJ00	20	39nH	±5%	12	0.65	300
20	LQG18HN47NJ00	20	47nH	±5%	12	0.70	300
21	LQG18HN56NJ00	20	56nH	±5%	12	0.75	300
22	LQG18HN68NJ00	20	68nH	±5%	12	0.80	300
23	LQG18HN82NJ00	20	82nH	±5%	12	0.85	300
24	LQG18HNR10J00	20	100nH	±5%	12	0.90	300

●EKLMOQ03A (High-frequency Film Type)

No.	Part Number	Quantity (pcs.)	Inductance		Q min.	DC Resistance (Ω) max.	Rated Current (mA)
			Nominal	Tolerance			
1	LQP03TN0N6C00	20	0.6nH	±0.2nH	11	0.08	420
2	LQP03TN0N8C00	20	0.8nH	±0.2nH	11	0.09	410
3	LQP03TN1N0C00	20	1.0nH	±0.2nH	11	0.10	400
4	LQP03TN1N2C00	20	1.2nH	±0.2nH	11	0.13	280
5	LQP03TN1N5C00	20	1.5nH	±0.2nH	11	0.16	280
6	LQP03TN1N8C00	20	1.8nH	±0.2nH	11	0.16	280
7	LQP03TN2N2C00	20	2.2nH	±0.2nH	11	0.18	220
8	LQP03TN2N7C00	20	2.7nH	±0.2nH	11	0.21	220
9	LQP03TN3N3C00	20	3.3nH	±0.2nH	11	0.30	190
10	LQP03TN3N9C00	20	3.9nH	±0.2nH	11	0.45	170
11	LQP03TN4N7J00	20	4.7nH	±5%	11	0.55	160
12	LQP03TN5N6J00	20	5.6nH	±5%	11	0.68	140
13	LQP03TN6N8J00	20	6.8nH	±5%	11	0.75	130
14	LQP03TN8N2J00	20	8.2nH	±5%	11	0.86	110
15	LQP03TN10NJ00	20	10nH	±5%	11	1.10	100
16	LQP03TN12NJ00	20	12nH	±5%	11	1.25	90
17	LQP03TN15NJ00	20	15nH	±5%	11	1.50	90

Design Kits

●EKLMP15A (High-frequency Film Type)

No.	Part Number	Quantity (pcs.)	Inductance		Q min.	DC Resistance (Ω) max.	Rated Current (mA)
			Nominal	Tolerance			
1	LQP15MN1N0B02	20	1.0nH	0.1nH	13	0.1	400
2	LQP15MN1N1B02	20	1.1nH	0.1nH	13	0.1	390
3	LQP15MN1N2B02	20	1.2nH	0.1nH	13	0.1	390
4	LQP15MN1N3B02	20	1.3nH	0.1nH	13	0.2	280
5	LQP15MN1N5B02	20	1.5nH	0.1nH	13	0.2	280
6	LQP15MN1N6B02	20	1.6nH	0.1nH	13	0.3	220
7	LQP15MN1N8B02	20	1.8nH	0.1nH	13	0.2	280
8	LQP15MN2N0B02	20	2.0nH	0.1nH	13	0.3	220
9	LQP15MN2N2B02	20	2.2nH	0.1nH	13	0.3	220
10	LQP15MN2N4B02	20	2.4nH	0.1nH	13	0.3	220
11	LQP15MN2N7B02	20	2.7nH	0.1nH	13	0.3	220
12	LQP15MN3N0B02	20	3.0nH	0.1nH	13	0.4	190
13	LQP15MN3N3B02	20	3.3nH	0.1nH	13	0.4	190
14	LQP15MN3N6B02	20	3.6nH	0.1nH	13	0.5	170
15	LQP15MN3N9B02	20	3.9nH	0.1nH	13	0.5	170
16	LQP15MN4N3B02	20	4.3nH	0.1nH	13	0.6	160
17	LQP15MN4N7B02	20	4.7nH	0.1nH	13	0.6	160
18	LQP15MN5N1B02	20	5.1nH	±0.1nH	13	0.7	140
19	LQP15MN5N6B02	20	5.6nH	±0.1nH	13	0.7	140
20	LQP15MN6N2B02	20	6.2nH	±0.1nH	13	0.9	130
21	LQP15MN6N8B02	20	6.8nH	±0.1nH	13	0.9	130
22	LQP15MN7N5B02	20	7.5nH	±0.1nH	13	1.1	110
23	LQP15MN8N2B02	20	8.2nH	±0.1nH	13	1.1	110
24	LQP15MN9N1B02	20	9.1nH	±0.1nH	13	1.3	100
25	LQP15MN10NG02	20	10nH	±2%	13	1.3	100
26	LQP15MN12NG02	20	12nH	±2%	13	1.6	90
27	LQP15MN15NG02	20	15nH	±2%	13	1.8	90
28	LQP15MN18NG02	20	18nH	±2%	13	2.0	80
29	LQP15MN22NG02	20	22nH	±2%	13	2.6	70
30	LQP15MN27NG02	20	27nH	±2%	13	3.1	70
31	LQP15MN33NG02	20	33nH	±2%	13	3.8	60

●EKLMP15A (High-frequency Winding Type)

No.	Part Number	Quantity (pcs.)	Inductance		Q min.	DC Resistance (Ω) max.	Rated Current (mA)
			Nominal	Tolerance			
1	LQW15AN1N5C	20	1.5nH	±0.2nH	10	0.03	1000
2	LQW15AN2N7C	20	2.7nH	±0.2nH	20	0.05	850
3	LQW15AN4N3C	20	4.3nH	±0.2nH	25	0.07	750
4	LQW15AN4N7C	20	4.7nH	±0.2nH	25	0.07	750
5	LQW15AN5N1C	20	5.1nH	±0.2nH	25	0.12	600
6	LQW15AN6N2C	20	6.2nH	±0.2nH	25	0.09	700
7	LQW15AN6N8H	20	6.8nH	±3%	25	0.09	700
8	LQW15AN7N5H	20	7.5nH	±3%	25	0.13	570
9	LQW15AN9N1H	20	9.1nH	±3%	25	0.14	540
10	LQW15AN10NH	20	10nH	±3%	25	0.17	500
11	LQW15AN12NH	20	12nH	±3%	30	0.14	500
12	LQW15AN15NH	20	15nH	±3%	30	0.16	460
13	LQW15AN18NH	20	18nH	±3%	25	0.27	370
14	LQW15AN22NH	20	22nH	±3%	25	0.30	310
15	LQW15AN27NH	20	27nH	±3%	25	0.52	280

Continued on the following page. 

Design Kits

 Continued from the preceding page.

No.	Part Number	Quantity (pcs.)	Inductance		Q min.	DC Resistance (Ω) max.	Rated Current (mA)
			Nominal	Tolerance			
16	LQW15AN33NH	20	33nH	±3%	25	0.63	260
17	LQW15AN39NH	20	39nH	±3%	25	0.70	250
18	LQW15AN47NH	20	47nH	±3%	25	1.08	210
19	LQW15AN56NH	20	56nH	±3%	25	1.17	200

●EKLMO18GA (High-frequency Winding Type)

No.	Part Number	Quantity (pcs.)	Inductance		Q min.	DC Resistance (Ω) max.	Rated Current (mA)
			Nominal	Tolerance			
1	LQW18AN3N6C00	20	3.6nH	±0.2nH	25	0.059	850
2	LQW18AN3N9C00	20	3.9nH	±0.2nH	35	0.059	850
3	LQW18AN4N3C00	20	4.3nH	±0.2nH	35	0.059	850
4	LQW18AN5N6C00	20	5.6nH	±0.2nH	35	0.082	750
5	LQW18AN6N2C00	20	6.2nH	±0.2nH	35	0.082	750
6	LQW18AN6N8C00	20	6.8nH	±0.2nH	35	0.082	750
7	LQW18AN10NG00	20	10nH	±2%	35	0.11	650
8	LQW18AN11NG00	20	11nH	±2%	35	0.11	650
9	LQW18AN12NG00	20	12nH	±2%	35	0.13	600
10	LQW18AN13NG00	20	13nH	±2%	35	0.13	600
11	LQW18AN15NG00	20	15nH	±2%	40	0.13	600
12	LQW18AN16NG00	20	16nH	±2%	40	0.16	550
13	LQW18AN18NG00	20	18nH	±2%	40	0.16	550
14	LQW18AN20NG00	20	20nH	±2%	40	0.16	550
15	LQW18AN22NG00	20	22nH	±2%	40	0.17	500
16	LQW18AN24NG00	20	24nH	±2%	40	0.21	500
17	LQW18AN27NG00	20	27nH	±2%	40	0.21	440
18	LQW18AN30NJ00	20	30nH	±2%	40	0.23	420
19	LQW18AN33NG00	20	33nH	±2%	40	0.23	420
20	LQW18AN36NG00	20	36nH	±2%	40	0.26	400
21	LQW18AN39NG00	20	39nH	±2%	40	0.26	400
22	LQW18AN43NG00	20	43nH	±2%	40	0.29	380
23	LQW18AN47NG00	20	47nH	±2%	38	0.29	380
24	LQW18AN51NG00	20	51nH	±2%	38	0.33	370
25	LQW18AN56NG00	20	56nH	±2%	38	0.35	360
26	LQW18AN62NG00	20	62nH	±2%	38	0.51	280
27	LQW18AN68NG00	20	68nH	±2%	38	0.38	340
28	LQW18AN72NG00	20	72nH	±2%	34	0.56	270
29	LQW18AN75NG00	20	75nH	±2%	34	0.56	270
30	LQW18AN82NG00	20	82nH	±2%	34	0.60	250
31	LQW18AN91NG00	20	91nH	±2%	34	0.64	230
32	LQW18ANR10G00	20	100nH	±2%	34	0.68	220
33	LQW18ANR11G00	20	110nH	±2%	32	1.2	200
34	LQW18ANR12G00	20	120nH	±2%	32	1.3	180
35	LQW18ANR13G00	20	130nH	±2%	32	1.4	170
36	LQW18ANR15G00	20	150nH	±2%	32	1.5	160
37	LQW18ANR16G00	20	160nH	±2%	32	2.1	150
38	LQW18ANR18G00	20	180nH	±2%	25	2.2	140
39	LQW18ANR20G00	20	200nH	±2%	25	2.4	120
40	LQW18ANR22G00	20	220nH	±2%	25	2.5	120
41	LQW18ANR27G00	20	270nH	±2%	30	3.4	110
42	LQW18ANR33G00	20	330nH	±2%	30	5.5	85
43	LQW18ANR39G00	20	390nH	±2%	30	6.2	80
44	LQW18ANR47G00	20	470nH	±2%	30	7.0	75

Continued on the following page. 

Design Kits

 Continued from the preceding page.

No.	Part Number	Quantity (pcs.)	Inductance		Q min.	DC Resistance (Ω) max.	Rated Current (mA)
			Nominal	Tolerance			
45	LQW18AN3N9C10	20	3.9nH	±0.2nH	38	0.032	1000
46	LQW18AN6N8C10	20	6.8nH	±0.2nH	38	0.045	900
47	LQW18AN10NG10	20	10nH	±2%	38	0.058	800
48	LQW18AN12NG10	20	12nH	±2%	38	0.071	750
49	LQW18AN18NG10	20	18nH	±2%	42	0.085	700
50	LQW18AN22NG10	20	22nH	±2%	42	0.099	640
51	LQW18AN27NG10	20	27nH	±2%	42	0.116	590

●EKLMQ18JA (High-frequency Winding Type)

No.	Part Number	Quantity (pcs.)	Inductance		Q min.	DC Resistance (Ω) max.	Rated Current (mA)
			Nominal	Tolerance			
1	LQW18AN2N2D10	20	2.2nH	±0.5nH	25	0.018	1400
2	LQW18AN3N6D00	20	3.6nH	±0.5nH	25	0.059	850
3	LQW18AN3N9D10	20	3.9nH	±0.5nH	38	0.032	1000
4	LQW18AN4N3D00	20	4.3nH	±0.5nH	35	0.059	850
5	LQW18AN4N7D00	20	4.7nH	±0.5nH	35	0.059	850
6	LQW18AN5N6D10	20	5.6nH	±0.5nH	38	0.045	900
7	LQW18AN6N2D00	20	6.2nH	±0.5nH	35	0.082	750
8	LQW18AN6N8D10	20	6.8nH	±0.5nH	38	0.045	900
9	LQW18AN7N5D00	20	7.5nH	±0.5nH	35	0.082	750
10	LQW18AN8N2D10	20	8.2nH	±0.5nH	38	0.058	800
11	LQW18AN8N7D00	20	8.7nH	±0.5nH	35	0.11	650
12	LQW18AN9N1D00	20	9.1nH	±0.5nH	35	0.11	650
13	LQW18AN9N5D00	20	9.5nH	±0.5nH	35	0.11	650
14	LQW18AN10NJ10	20	10nH	±5%	38	0.058	800
15	LQW18AN11NJ00	20	11nH	±5%	35	0.11	650
16	LQW18AN12NJ10	20	12nH	±5%	38	0.071	750
17	LQW18AN13NJ00	20	13nH	±5%	35	0.13	600
18	LQW18AN15NJ10	20	15nH	±5%	42	0.085	700
19	LQW18AN16NJ00	20	16nH	±5%	40	0.16	550
20	LQW18AN18NJ10	20	18nH	±5%	42	0.085	700
21	LQW18AN20NJ00	20	20nH	±5%	40	0.16	550
22	LQW18AN22NJ10	20	22nH	±5%	42	0.099	640
23	LQW18AN24NJ00	20	24nH	±5%	40	0.21	500
24	LQW18AN27NJ10	20	27nH	±5%	42	0.116	590
25	LQW18AN30NJ00	20	30nH	±5%	40	0.23	420
26	LQW18AN33NJ10	20	33nH	±5%	42	0.132	550
27	LQW18AN36NJ00	20	36nH	±5%	40	0.26	400
28	LQW18AN39NJ00	20	39nH	±5%	40	0.26	400
29	LQW18AN43NJ00	20	43nH	±5%	40	0.29	380
30	LQW18AN47NJ00	20	47nH	±5%	38	0.29	380
31	LQW18AN51NJ00	20	51nH	±5%	38	0.33	370
32	LQW18AN56NJ00	20	56nH	±5%	38	0.35	360
33	LQW18AN62NJ00	20	62nH	±5%	38	0.51	280
34	LQW18AN68NJ00	20	68nH	±5%	38	0.38	340
35	LQW18AN72NJ00	20	72nH	±5%	34	0.56	270
36	LQW18AN75NJ00	20	75nH	±5%	34	0.56	270
37	LQW18AN82NJ00	20	82nH	±5%	34	0.60	250
38	LQW18AN91NJ00	20	91nH	±5%	34	0.64	230
39	LQW18ANR10J00	20	100nH	±5%	34	0.68	220
40	LQW18ANR11J00	20	110nH	±5%	32	1.2	200
41	LQW18ANR12J00	20	120nH	±5%	32	1.3	180

Continued on the following page. 

Design Kits

 Continued from the preceding page.

No.	Part Number	Quantity (pcs.)	Inductance		Q min.	DC Resistance (Ω) max.	Rated Current (mA)
			Nominal	Tolerance			
42	LQW18ANR13J00	20	130nH	±5%	32	1.4	170
43	LQW18ANR15J00	20	150nH	±5%	32	1.5	160
44	LQW18ANR16J00	20	160nH	±5%	32	2.1	150
45	LQW18ANR18J00	20	180nH	±5%	25	2.2	140
46	LQW18ANR20J00	20	200nH	±5%	25	2.4	120
47	LQW18ANR22J00	20	220nH	±5%	25	2.5	120
48	LQW18ANR27J00	20	270nH	±5%	30	3.4	110
49	LQW18ANR33J00	20	330nH	±5%	30	5.5	85
50	LQW18ANR39J00	20	390nH	±5%	30	6.2	80
51	LQW18ANR47J00	20	470nH	±5%	30	7.0	75

●EKLMQW2BA (High-frequency Winding Type)

No.	Part Number	Quantity (pcs.)	Inductance		Q min.	DC Resistance (Ω) max.	Rated Current (mA)
			Nominal	Tolerance			
1	LQW2BHN2N7D11	20	2.7nH	±0.5nH	20	0.02	1900
2	LQW2BHN3N1D11	20	3.1nH	±0.5nH	20	0.02	1800
3	LQW2BHN3N3D11	20	3.3nH	±0.5nH	20	0.02	1700
4	LQW2BHN5N6D11	20	5.6nH	±0.5nH	35	0.02	1500
5	LQW2BHN6N8D11	20	6.8nH	±0.5nH	35	0.02	1400
6	LQW2BHN8N6D11	20	8.6nH	±0.5nH	35	0.03	1300
7	LQW2BHN10NJ11	20	10nH	±5%	35	0.03	1320
8	LQW2BHN12NK11	20	12nH	±10%	40	0.04	1100
9	LQW2BHN15NK11	20	15nH	±10%	40	0.04	1000
10	LQW2BHN18NK11	20	18.8nH	±10%	40	0.05	1000
11	LQW2BHN21NK11	20	21nH	±10%	40	0.05	950
12	LQW2BHN27NK11	20	27nH	±10%	40	0.06	900
13	LQW2BHN33NJ01	20	33nH	±5%	40	0.15	570
14	LQW2BHN39NJ01	20	39nH	±5%	40	0.09	730
15	LQW2BHN47NJ01	20	47nH	±5%	40	0.23	450
16	LQW2BHN56NJ01	20	56nH	±5%	40	0.26	430
17	LQW2BHN68NJ01	20	68nH	±5%	40	0.23	460
18	LQW2BHN82NJ01	20	82nH	±5%	40	0.42	320
19	LQW2BHNR10J01	20	100nH	±5%	40	0.38	350
20	LQW2BHNR12J01	20	120nH	±5%	40	0.40	320
21	LQW2BHNR15J01	20	150nH	±5%	30	0.47	390
22	LQW2BHNR18J01	20	180nH	±5%	35	0.71	250
23	LQW2BHNR22J01	20	220nH	±5%	35	0.70	240
24	LQW2BHNR27K01	20	270nH	±10%	15	2.00	190
25	LQW2BHNR33K01	20	330nH	±10%	15	2.20	180
26	LQW2BHNR39K01	20	390nH	±10%	15	2.50	170
27	LQW2BHNR47K01	20	470nH	±10%	15	2.80	160

●EKLQM18A (for General Use Monolithic Type)

No.	Part Number	Quantity (pcs.)	Inductance		Q min.	DC Resistance (Ω) max.	Rated Current (mA)
			Nominal	Tolerance			
1	LQM18NN47NM00	20	47nH	±20%	10	0.30	50
2	LQM18NN68NM00	20	68nH	±20%	10	0.30	50
3	LQM18NN82NM00	20	82nH	±20%	10	0.30	50
4	LQM18NNR10K00	20	100nH	±10%	15	0.50	50
5	LQM18NNR12K00	20	120nH	±10%	15	0.50	50

Continued on the following page. 

Design Kits

 Continued from the preceding page.

No.	Part Number	Quantity (pcs.)	Inductance		Q min.	DC Resistance (Ω) max.	Rated Current (mA)
			Nominal	Tolerance			
6	LQM18NNR15K00	20	150nH	±10%	15	0.60	50
7	LQM18NNR18K00	20	180nH	±10%	15	0.60	50
8	LQM18NNR22K00	20	220nH	±10%	15	0.80	50
9	LQM18NNR27K00	20	270nH	±10%	15	0.80	50
10	LQM18NNR33K00	20	330nH	±10%	15	0.85	35
11	LQM18NNR39K00	20	390nH	±10%	15	1.00	35
12	LQM18NNR47K00	20	470nH	±10%	15	1.35	35
13	LQM18NNR56K00	20	560nH	±10%	15	1.55	35
14	LQM18NNR68K00	20	680nH	±10%	15	1.70	35
15	LQM18NNR82K00	20	820nH	±10%	15	2.10	35
16	LQM18NN1R0K00	20	1000nH	±10%	35	0.60	25
17	LQM18NN1R2K00	20	1200nH	±10%	35	0.80	25
18	LQM18NN1R5K00	20	1500nH	±10%	35	0.80	25
19	LQM18NN1R8K00	20	1800nH	±10%	35	0.95	25
20	LQM18NN2R2K00	20	2200nH	±10%	35	1.15	15

●EKLMM21NA (for General Use Monolithic Type)

No.	Part Number	Quantity (pcs.)	Inductance		Q min.	DC Resistance (Ω)	Rated Current (mA)
			Nominal	Tolerance			
1	LQM21NNR10K10	20	0.1μH	±10%	20	0.17±50%	250
2	LQM21NNR12K10	20	0.12μH	±10%	20	0.19±50%	250
3	LQM21NNR15K10	20	0.15μH	±10%	20	0.21±50%	250
4	LQM21NNR18K10	20	0.18μH	±10%	20	0.23±50%	250
5	LQM21NNR22K10	20	0.22μH	±10%	20	0.25±50%	250
6	LQM21NNR27K10	20	0.27μH	±10%	20	0.28±50%	250
7	LQM21NNR33K10	20	0.33μH	±10%	20	0.32±50%	250
8	LQM21NNR39K10	20	0.39μH	±10%	25	0.35±50%	200
9	LQM21NNR47K10	20	0.47μH	±10%	25	0.38±50%	200
10	LQM21NNR56K10	20	0.56μH	±10%	25	0.42±50%	150
11	LQM21NNR68K10	20	0.68μH	±10%	25	0.48±50%	150
12	LQM21NNR82K10	20	0.82μH	±10%	25	0.54±50%	150
13	LQM21NN1R0K10	20	1.0μH	±10%	30	0.28±50%	50
14	LQM21NN1R2K10	20	1.2μH	±10%	30	0.31±50%	50
15	LQM21NN1R5K10	20	1.5μH	±10%	30	0.34±50%	50
16	LQM21NN1R8K10	20	1.8μH	±10%	30	0.38±50%	50
17	LQM21NN2R2K10	20	2.2μH	±10%	30	0.42±50%	30
18	LQM21NN2R7K10	20	2.7μH	±10%	30	0.46±50%	30
19	LQM21NN3R3K10	20	3.3μH	±10%	30	0.54±50%	30
20	LQM21NN3R9K10	20	3.9μH	±10%	30	0.59±50%	30
21	LQM21NN4R7K10	20	4.7μH	±10%	30	0.70±50%	30

●EKLMM21FA (for Choke Monolithic Type)

No.	Part Number	Quantity (pcs.)	Inductance		DC Resistance (Ω)	Rated Current (mA)
			Nominal	Tolerance		
1	LQM21FN1R0N00	20	1.0μH	±30%	0.20±30%	220
2	LQM21FN2R2N00	20	2.2μH	±30%	0.28±30%	150
3	LQM21FN4R7N00	20	4.7μH	±30%	0.30±30%	80
4	LQM21FN100N00	20	10μH	±30%	0.50±30%	60
5	LQM21FN220N00	20	22μH	±30%	0.35±30%	13
6	LQM21FN470N00	20	47μH	±30%	0.60±30%	7

Continued on the following page. 

Design Kits

 Continued from the preceding page.

No.	Part Number	Quantity (pcs.)	Inductance		DC Resistance (Ω)	Rated Current (mA)
			Nominal	Tolerance		
7	LQM31FN100M00	20	10μH	±20%	0.5 max.	70

●EKL32MA (for General Use Winding Type)

No.	Part Number	Quantity (pcs.)	Inductance		DC Resistance (Ω) max.	Rated Current (mA)
			Nominal	Tolerance		
1	LQH32MNR10M21	20	0.1μH	±20%	0.25	700
2	LQH32MNR18M21	20	0.18μH	±20%	0.25	650
3	LQH32MNR27M21	20	0.27μH	±20%	0.25	600
4	LQH32MNR39M21	20	0.39μH	±20%	0.25	530
5	LQH32MNR56M21	20	0.56μH	±20%	0.25	530
6	LQH32MNR68M21	20	0.68μH	±20%	0.25	470
7	LQH32MNR82M21	20	0.82μH	±20%	0.25	450
8	LQH32MN1R0M21	20	1.0μH	±20%	0.50	445
9	LQH32MN1R2M21	20	1.2μH	±20%	0.60	425
10	LQH32MN1R5K21	20	1.5μH	±10%	0.60	400
11	LQH32MN1R8K21	20	1.8μH	±10%	0.70	390
12	LQH32MN2R2K21	20	2.2μH	±10%	0.80	370
13	LQH32MN2R7K21	20	2.7μH	±10%	0.90	320
14	LQH32MN3R3K21	20	3.3μH	±10%	1.00	300
15	LQH32MN3R9K21	20	3.9μH	±10%	1.10	290
16	LQH32MN4R7K21	20	4.7μH	±10%	1.20	270
17	LQH32MN5R6K21	20	5.6μH	±10%	1.30	250
18	LQH32MN6R8K21	20	6.8μH	±10%	1.50	240
19	LQH32MN8R2K21	20	8.2μH	±10%	1.60	225
20	LQH32MN100K21	20	10μH	±10%	1.8	190
21	LQH32MN120K21	20	12μH	±10%	2.0	180
22	LQH32MN150K21	20	15μH	±10%	2.2	170
23	LQH32MN180K21	20	18μH	±10%	2.5	165
24	LQH32MN220K21	20	22μH	±10%	2.8	150
25	LQH32MN270K21	20	27μH	±10%	3.1	125
26	LQH32MN330K21	20	33μH	±10%	3.5	115
27	LQH32MN390K21	20	39μH	±10%	3.9	110
28	LQH32MN470K21	20	47μH	±10%	4.3	100
29	LQH32MN560K21	20	56μH	±10%	4.9	85
30	LQH32MN680K21	20	68μH	±10%	5.5	80
31	LQH32MN820K21	20	82μH	±10%	6.2	70
32	LQH32MN101K21	20	100μH	±10%	7.0	80
33	LQH32MN121K21	20	120μH	±10%	8.0	75
34	LQH32MN151K21	20	150μH	±10%	9.3	70
35	LQH32MN181K21	20	180μH	±10%	10.2	65
36	LQH32MN221K21	20	220μH	±10%	11.8	65
37	LQH32MN271K21	20	270μH	±10%	12.5	65
38	LQH32MN331K21	20	330μH	±10%	13.0	65
39	LQH32MN391K21	20	390μH	±10%	22.0	50
40	LQH32MN471K21	20	470μH	±10%	25.0	45
41	LQH32MN561K21	20	560μH	±10%	28.0	40

Design Kits

●EKL43MA (for General Use Winding Type)

No.	Part Number	Quantity (pcs.)	Inductance		DC Resistance (Ω) max.	Rated Current (mA)
			Nominal	Tolerance		
1	LQH43MN1R0M01	10	1.0μH	±20%	0.20	500
2	LQH43MN1R2M01	10	1.2μH	±20%	0.20	500
3	LQH43MN1R5M01	10	1.5μH	±20%	0.30	500
4	LQH43MN1R8M01	10	1.8μH	±20%	0.30	500
5	LQH43MN2R2M01	10	2.2μH	±20%	0.30	500
6	LQH43MN2R7M01	10	2.7μH	±20%	0.32	500
7	LQH43MN3R3M01	10	3.3μH	±20%	0.35	500
8	LQH43MN3R9M01	10	3.9μH	±20%	0.38	500
9	LQH43MN4R7K01	10	4.7μH	±10%	0.40	500
10	LQH43MN5R6K01	10	5.6μH	±10%	0.47	500
11	LQH43MN6R8K01	10	6.8μH	±10%	0.50	450
12	LQH43MN8R2K01	10	8.2μH	±10%	0.56	450
13	LQH43MN100K01	10	10μH	±10%	0.56	400
14	LQH43MN120K01	10	12μH	±10%	0.62	380
15	LQH43MN150K01	10	15μH	±10%	0.73	360
16	LQH43MN180K01	10	18μH	±10%	0.82	340
17	LQH43MN220K01	10	22μH	±10%	0.94	320
18	LQH43MN270K01	10	27μH	±10%	1.10	300
19	LQH43MN330K01	10	33μH	±10%	1.20	270
20	LQH43MN390K01	10	39μH	±10%	1.40	240
21	LQH43MN470K01	10	47μH	±10%	1.50	220
22	LQH43MN560K01	10	56μH	±10%	1.7	200
23	LQH43MN680K01	10	68μH	±10%	1.9	180
24	LQH43MN820K01	10	82μH	±10%	2.2	170
25	LQH43MN101K01	10	100μH	±10%	2.5	160
26	LQH43MN121K01	10	120μH	±10%	3.0	150
27	LQH43MN151K01	10	150μH	±10%	3.7	130
28	LQH43MN181K01	10	180μH	±10%	4.5	120
29	LQH43MN221K01	10	220μH	±10%	5.4	110
30	LQH43MN271K01	10	270μH	±10%	6.8	100
31	LQH43MN331K01	10	330μH	±10%	8.2	95
32	LQH43MN391K01	10	390μH	±10%	9.7	90
33	LQH43MN471K01	10	470μH	±10%	11.8	80
34	LQH43MN561K01	10	560μH	±10%	14.5	70
35	LQH43MN681K01	10	680μH	±10%	17.0	65
36	LQH43MN821K01	10	820μH	±10%	20.5	60
37	LQH43MN102K01	10	1000μH	±10%	25.0	50
38	LQH43MN122K01	10	1200μH	±10%	30.0	45
39	LQH43MN152K01	10	1500μH	±10%	37.0	40
40	LQH43NN182K01	10	1800μH	±10%	45.0	35
41	LQH43NN222K01	10	2200μH	±10%	50.0	30

●EKL43CA (for Choke Winding Type)

No.	Part Number	Quantity (pcs.)	Inductance		DC Resistance (Ω)	Rated Current (mA)
			Nominal	Tolerance		
1	LQH32CN1R0M11	20	1.0μH	±20%	0.06±30%	1000
2	LQH32CN2R2M11	20	2.2μH	±20%	0.097±30%	790
3	LQH32CN4R7M11	20	4.7μH	±20%	0.15±30%	650
4	LQH32CN100K11	20	10μH	±10%	0.3±30%	450
5	LQH32CN1R0M21	20	1.0μH	±20%	0.09±30%	800

Continued on the following page. 

Design Kits

Continued from the preceding page.

No.	Part Number	Quantity (pcs.)	Inductance		DC Resistance (Ω)	Rated Current (mA)
			Nominal	Tolerance		
6	LQH32CN2R2M21	20	2.2μH	±20%	0.13±30%	600
7	LQH32CN4R7M21	20	4.7μH	±20%	0.2±30%	450
8	LQH32CN100K21	20	10μH	±10%	0.44±30%	300
9	LQH32CN220K21	20	22μH	±10%	0.71±30%	250
10	LQH32CN470K21	20	47μH	±10%	1.3±30%	170
11	LQH32CN101K21	20	100μH	±10%	3.5±30%	100
12	LQH32CN221K21	20	220μH	±10%	8.4±30%	70
13	LQH32CN331K21	20	330μH	±10%	10±30%	60
14	LQH32CN391K21	20	390μH	±10%	17±30%	60
15	LQH32CN471K21	20	470μH	±10%	19±30%	60
16	LQH32CN561K21	20	560μH	±10%	22±30%	60
17	LQH32CN1R0M51	20	1.0μH	±20%	0.06±30%	1000
18	LQH32CN2R2M51	20	2.2μH	±20%	0.097±30%	790
19	LQH32CN4R7M51	20	4.7μH	±20%	0.15±30%	650
20	LQH32CN100K51	20	10μH	±10%	0.3±30%	450
21	LQH32CN150K51	20	15μH	±10%	0.58±30%	300
22	LQH32CN220K51	20	22μH	±10%	0.71±30%	250
23	LQH32CN330K51	20	33μH	±10%	1.1±30%	200
24	LQH32CN470K51	20	47μH	±10%	1.3±30%	170
25	LQH32CN680K51	20	68μH	±10%	2.2±30%	130
26	LQH32CN101K51	20	100μH	±10%	3.5±30%	100

●EKL43CA (for Choke Winding Type)

No.	Part Number	Quantity (pcs.)	Inductance		DC Resistance (Ω)	Rated Current (mA)
			Nominal	Tolerance		
1	LQH43CN1R0M01	10	1.0μH	±20%	0.08 max	1080
2	LQH43CN1R5M01	10	1.5μH	±20%	0.09 max	1000
3	LQH43CN2R2M01	10	2.2μH	±20%	0.11 max	900
4	LQH43CN3R3M01	10	3.3μH	±20%	0.13 max	800
5	LQH43CN4R7M01	10	4.7μH	±20%	0.15 max	750
6	LQH43CN6R8M01	10	6.8μH	±20%	0.20 max	720
7	LQH43CN100K01	10	10μH	±10%	0.24 max	650
8	LQH43CN150K01	10	15μH	±10%	0.32 max	570
9	LQH43CN220K01	10	22μH	±10%	0.60 max	420
10	LQH43CN330K01	10	33μH	±10%	1.00 max	310
11	LQH43CN470K01	10	47μH	±10%	1.10 max	280
12	LQH43CN680K01	10	68μH	±10%	1.70 max	220
13	LQH43CN101K01	10	100μH	±10%	2.20 max	190
14	LQH43CN151K01	10	150μH	±10%	3.50 max	130
15	LQH43CN221K01	10	220μH	±10%	4.00 max	110
16	LQH43CN331K01	10	330μH	±10%	6.80 max	100
17	LQH43CN471K01	10	470μH	±10%	8.50 max	90
18	LQH3KSN561N21	10	560μH	±30%	7.8±30%	50
19	LQH3KSN681N21	10	680μH	±30%	9.1±30%	40
20	LQH3KSN102N21	10	1000μH	±30%	11±30%	30
21	LQH3KSN152N21	10	1500μH	±30%	23±30%	25
22	LQH3KSN222N21	10	2200μH	±30%	28±30%	20

Information

1. Land Area and Q-F Characteristics

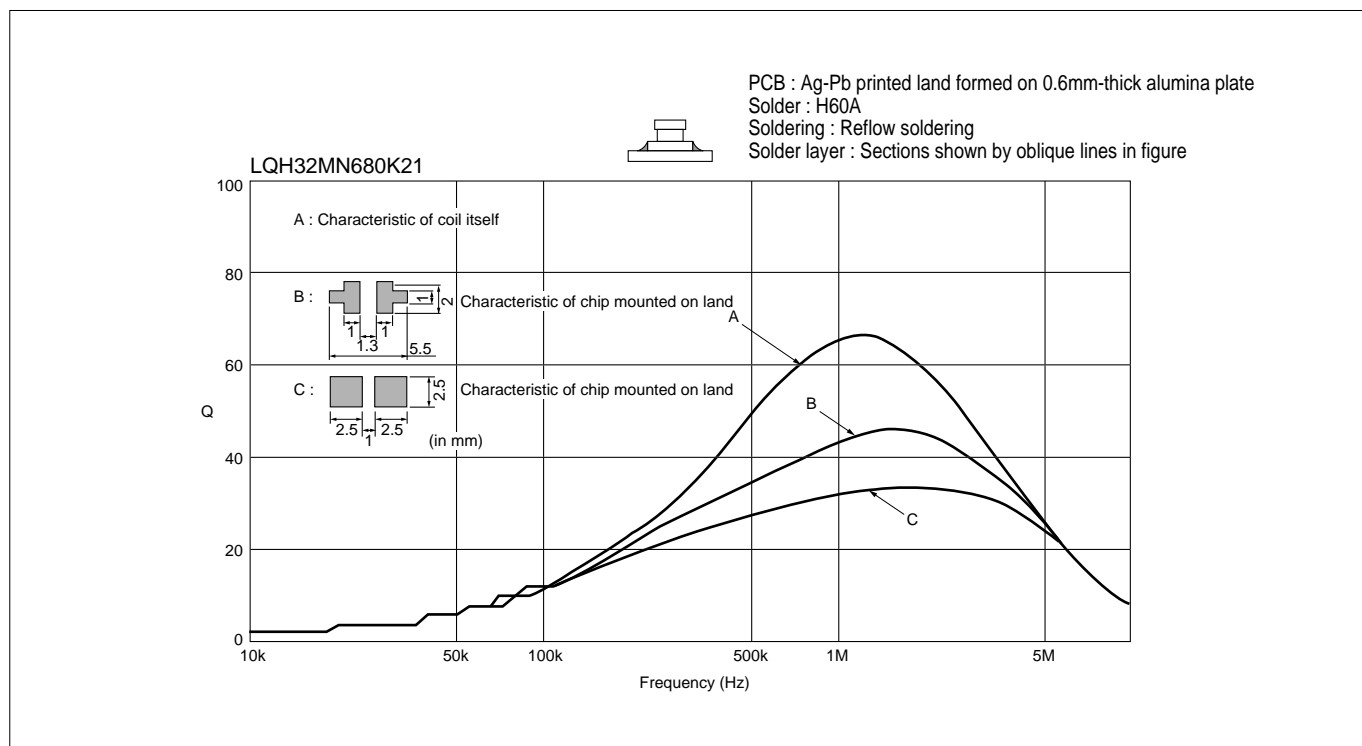

2. Coupling coefficient versus Coil-to-coil Spacing

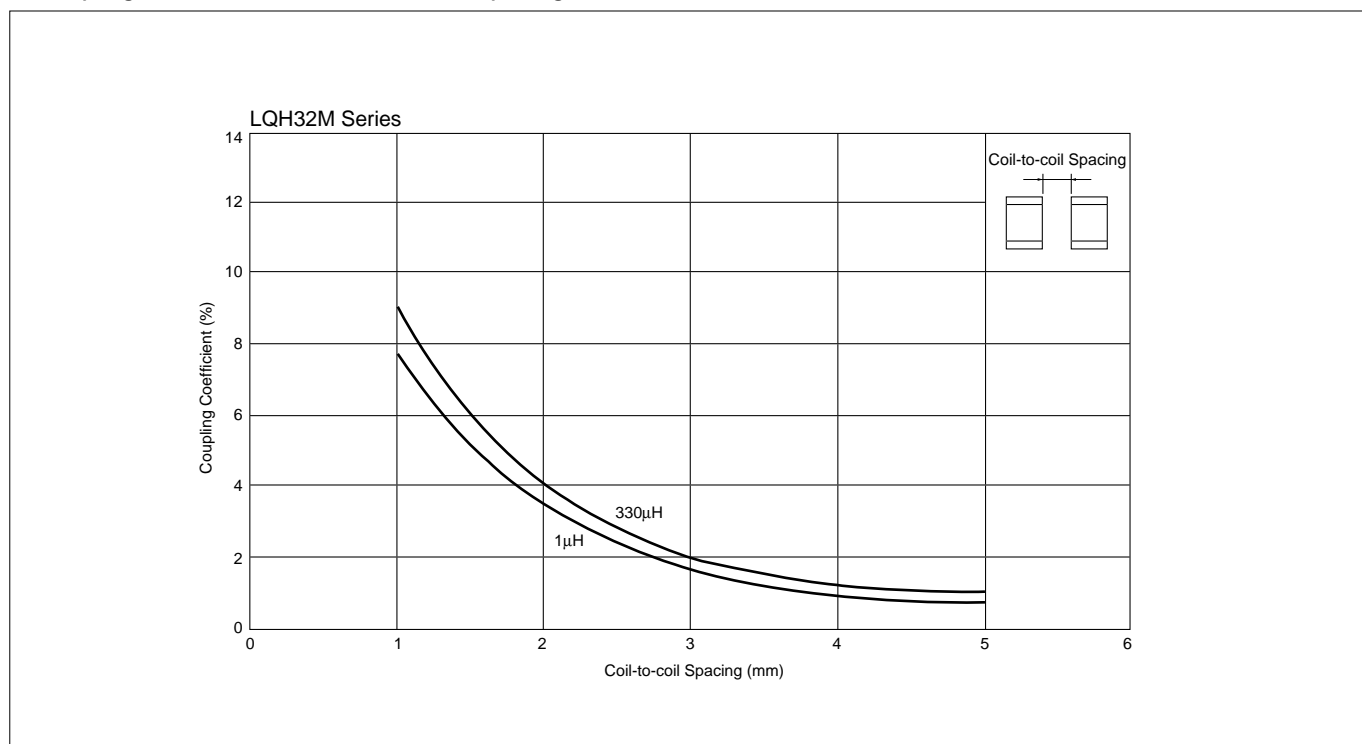

⚠ Note:

1. Export Control

⟨For customers outside Japan⟩

Murata products should not be used or sold for use in the development, production, stockpiling or utilization of any conventional weapons or mass-destructive weapons (nuclear weapons, chemical or biological weapons, or missiles), or any other weapons.

⟨For customers in Japan⟩

For products which are controlled items subject to the "Foreign Exchange and Foreign Trade Law" of Japan, the export license specified by the law is required for export.

2. Please contact our sales representatives or product engineers before using our products listed in this catalog for the applications listed below which require especially high reliability for the prevention of defects which might directly cause damage to the third party's life, body or property, or when intending to use one of our products for other applications than specified in this catalog.

- | | |
|-----------------------------|---|
| ① Aircraft equipment | ② Aerospace equipment |
| ③ Undersea equipment | ④ Power plant equipment |
| ⑤ Medical equipment | ⑥ Transportation equipment (vehicles, trains, ships, etc.) |
| ⑦ Traffic signal equipment | ⑧ Disaster prevention / crime prevention equipment |
| ⑨ Data-processing equipment | ⑩ Application of similar complexity and/or reliability requirements to the applications listed in the above |

3. Product specifications in this catalog are as of January 2002. They are subject to change or our products in it may be discontinued without advance notice. Please check with our sales representatives or product engineers before ordering. If there are any questions, please contact our sales representatives or product engineers.

4. Please read CAUTION and Notice in this catalog for safety. This catalog has only typical specifications. Therefore you are requested to approve our product specification or to transact the approval sheet for product specification, before ordering.

5. Please note that unless otherwise specified, we shall assume no responsibility whatsoever for any conflict or dispute that may occur in connection with the effect of our and/or third party's intellectual property rights and other related rights in consideration of your using our products and/or information described or contained in our catalogs. In this connection, no representation shall be made to the effect that any third parties are authorized to use the rights mentioned above under licenses without our consent.

6. No ozone depleting substances (ODS) under the Montreal Protocol are used in our manufacturing process.