

IRPP3624-05A *POWIR+* Chipset Reference Design #0611

POWIR+TM CHIPSET

SIMPLICITY IN POWER DESIGN

**5Amp Single Phase Synchronous Buck
*POWIR+*TM Chipset Reference Design
using IR3624MPBF PWM & Driver IC and
IRF9910PBF Dual SO-8 MOSFET**

By Steve Oknaian, Senior Applications Engineer

Table of Contents

	Page
Introduction	3
Design Details	3
Start-Up Procedure	4
Layout Considerations	4
Circuit Schematic	6
Complete Bill of Materials.....	7
PCB layouts	8-9
Electrical Efficiency & Power Loss	10
Thermal Performance & Bode Plot.....	11
Input & Output Ripple Waveforms.....	12
Load Step Waveforms.....	13
Power Up & Power Down Waveforms.....	14
IRPP3637-xxA Reference Design Selector Table	15

Introduction

The IRPP3624-05A is an optimized POWIR+™ Chipset reference design, targeted at low cost, low power synchronous buck applications up to 5A output current. The IRPP3624-05A uses International Rectifier's IR3624MPBF single channel, 600kHz fixed switching frequency PWM controller in a 10-pin MLPD and IRF9910PBF dual SO-8 MOSFET. This reference design has built-in power design expertise regarding component selection and PCB layout, and is representative of a realistic final embedded synchronous buck design, intended to simplify the design in effort without unnecessary design iterations. The design is optimized for 12V input and 3.3V output @ 5A, including considerations on layout and passive & magnetic component selection. The IRPP3624-05A delivers the complete 5A design in less than 0.5in² board area at up to 88% full load electrical efficiency.

International Rectifier also offers the POWIR+ Chipset on-line design tool (<http://powirplus.irf.com>) allowing the customization of the IRPP3624-05A reference design to meet individual requirements. Based on specific inputs, the POWIR+ Chipset on-line design tool will provide a tailored schematic and bill of materials, from which the engineer can run a full suite of on-line design simulations, and then order the fully assembled and tested customized reference design (see details on page 14).

Design Details

The IRPP3624-05A reference design is optimized for an input voltage range of 10.8V to 13.2V and an output voltage of 3.3V at a maximum of 5A load current,

using the IRF9910PBF dual SO-8 MOSFET.

The 600kHz switching frequency allows the selection of reduced size power components. All the essential components that contribute to a low cost compact solution are enclosed by the rectangular box shown on the PCB, showing a total solution size of 0.75" x 0.625" (0.7"sq). The electrical connection diagram is shown in figure 1 and the corresponding circuit schematic is shown in figure 2.

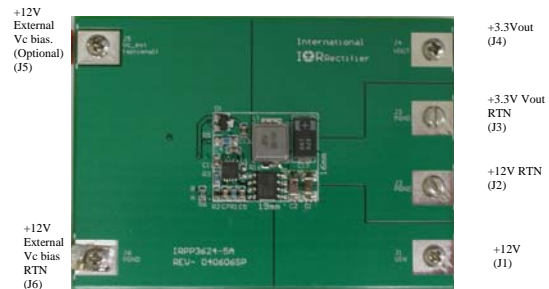

Figure 1: IRPP3624-05A Electrical Connection Diagram

Input/Output Connections

- J1: Input power connection terminal
- J2: Input power return preferred connection terminal
- J3: Output power return preferred connection terminal
- J4: Output power connection terminal
- J5: External bias power connection terminal. This terminal is unused for standard reference design configuration.
- J6: External bias power return preferred connection terminal. This terminal is unused for standard reference design configuration.

Start-Up Procedure

The 12V input power is connected between terminals J1 and J2 and the 3.3V, 5A output power is obtained through terminals J3 and J4.

The V_{CC} and V_C pins are the low side driver and high side driver power input pins respectively. The V_{CC} pin also includes the housekeeping power of the PWM controller. An under-voltage lockout (UVLO) feature is associated with each of these pins, which is set to 4.2V for V_{CC} and 3.2V for V_C . A charge pump circuit comprised of C11, D1, and C12 applies adequate voltage to the V_C pin to allow fast driving capability, hence reducing the switching losses of the control FET (Q1, inside the dual-SO8 package). A 25Ω resistor (R11 in parallel with R12) is added in series with the charge pump circuit to maintain the V_C voltage below 20V to reduce the temperature of the PWM controller IC.

Upon application of the input power, the output starts ramping up to regulation within 4ms. The ramping time can be adjusted through the soft start capacitor C5. The output voltage of the synchronous buck regulator is set to 3.3V using the internal 0.6V reference voltage.

The following equations are used to calculate the MOSFET power loss. Refer to the IRF9910PBF datasheet to select the parametric values of the power loss equations terms.

Control FET Losses:

Eq (1):

$$P_{Q_1} = I_{Q_1} rms^2 \cdot R_{DQ1} \cdot R_{Dn} + \left(I_o \cdot \frac{Q_{sw1}}{I_{g1}} \cdot V_{in} + Q_{gQ1} \cdot V_{dd} + Q_{ossQ1} \cdot V_{in} \right) \cdot F_{sw}$$

Synchronous FET Losses:

Eq (2):

$$P_{Q_2} = I_{Q_2} rms^2 \cdot R_{DQ2} \cdot R_{Dn} + \left(\frac{Q_{ossQ2}}{2} \cdot V_{in} + Q_{gQ2} \cdot V_{dd} + Q_{rrQ2} \cdot V_{in} \right) \cdot F_{sw}$$

Deadtime losses:

Eq (3):

$$P_{td} = V_{SD} \cdot I_o \cdot t_d \cdot F_{sw}$$

Total FET losses:

Eq (4):

$$P_{FET_total} = P_{Q_1} + P_{Q_2} + P_{td}$$

Where,

I_{Q1rms} and I_{Q2rms} are the rms currents for control and sync FETs respectively, in Amps

I_o is the output load current in Amps

R_D is the R_{DSON} in ohms of the FETs and R_{Dn} is the normalized R_{DSON} factor vs temperature extracted from the IRF9910PBF datasheet.

Q_{sw} is the FET switch charge in nC

V_{in} is the input voltage of the sync buck converter

Q_g is the total gate charge in nC.

V_{dd} is the FET drive voltage, which is 8V.

I_g is the drive current which is 0.5A.

Q_{oss} is the FET output charge in nC.

Q_{rr} is the sync FET internal body diode reverse recovery charge in nC

V_{SD} is the sync FET internal body diode forward voltage drop in volts. F_{sw} is the switching frequency of the sync buck converter in hertz.

t_d is the dead time caused by the PWM controller IC in seconds. This parameter is specified in IR3624MPBF datasheet.

For design calculations related to programming the output voltage and the soft start time, selection of input/output capacitors and output inductor and control loop compensation, refer to the guidelines outlined in the IR3624MPBF PWM controller datasheet.

IR's online design tool POWIR+ should be used to customize a design for applications outside the standard 10.8V to 13.2V input range and 3.3V output, and for varied design goal objectives.

Layout Considerations

The IRPP3624-05A reference design PCB layout offers compact design with minimum parasitics at 600kHz switching frequency. The board is designed with 4 layers using 1 oz copper weight per layer. Figures 3a through 3d represent the layout of each layer. To minimize the parasitics, the following was observed:

1. The switch node connection path is made as short as possible by placing the output inductor L1 close to the drain of the synchronous FET inside the dual SO8 package.
2. The input decoupling 10uF ceramic capacitors C1 and C2, are placed across the drain of the control FET and the ground pin of the dual SO8 package.
3. A solid ground plane is furnished in mid-layer 2. The connection of the signal ground to power ground is done at a single point in the bottom layer as shown in figure 3d.
4. The feedback track from the output V_{OUT} to FB pin of the IC is routed as far away from noise generating traces as possible in mid-layer 2 as shown in figure 3c.

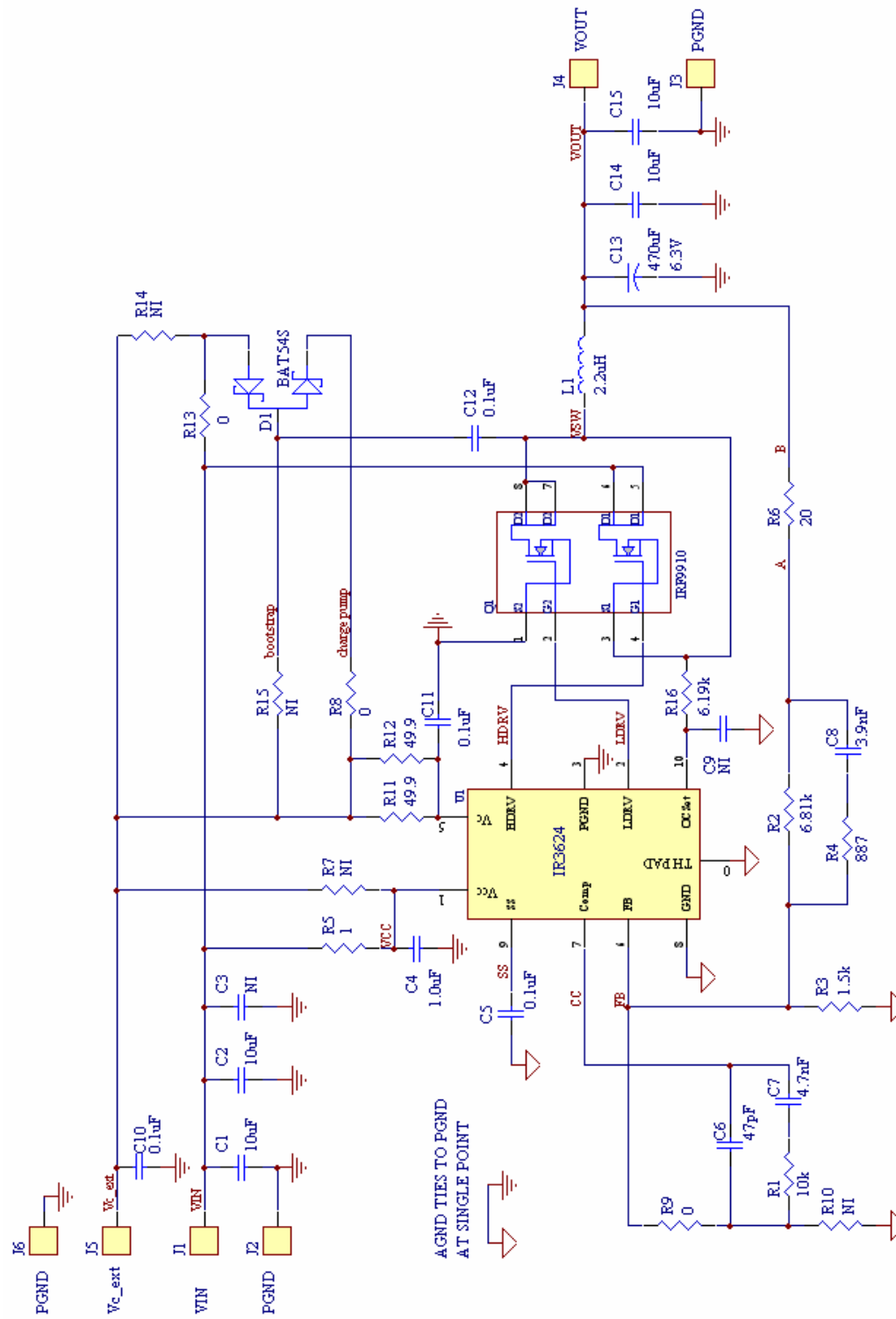

Figure 2: Schematic Diagram for IRPP3624-05A Reference Design

QTY	REF DESIGNATOR	DESCRIPTION	SIZE	MFR	PART NUMBER
1	C6	Capacitor, ceramic, 47pF, 50V,NPO, 5%	0603	KOA	NPO0603HTTD470J
1	C8	Capacitor, ceramic, 3.9nF, 50V,X7R, 10%	0603	KOA	0603X7RHT392K
1	C7	Capacitor, ceramic, 4.7nF,50V,X7R,10%	0603	Phycomp	06032R472K8B20
4	C5, C10, C11, C12	Capacitor, ceramic, 0.1µF, 50V, X7R, 10%	0603	TDK	C1608X7R1H104K
1	C4	Capacitor, ceramic, 1.0µF, 16V, X5R, 10%	0603	TDK	C1608X5R1C105K
2	C14, C15	Capacitor, ceramic, 10µF, 6.3V, X5R, 20%	1206	TDK	C3216X5R0J106M
2	C1, C2	Capacitor, ceramic, 10µF, 16V, X5R, 20%	1206	TDK	C3216X5R1C106M
1	C13	Capacitor, POSCAP, 470µF, 6.3V 20%	7343	SANYO	6TPB470M
1	D1	Schottky Diode, 30V,200mA	SOT23	IRF	BAT54S
3	J1, J4, J5	Red Banana Jacks-Insulated Solder Terminal	4.44mm	Johnson	108-0902-001
3	J2, J3, J6	Black Banana Jacks-Insulated Solder Terminal	4.44mm	Johnson	108-0903-001
4	J1, J4, J5, J6	Pan Head Slotted,screw 1/2"	-	McMaster-Carr	91792A081
2	J2, J3	Pan Head Slotted,screw 1/4"	-	McMaster-Carr	91792A077
6	J1, J2, J3, J4, J5, J6	Machine Screw Hex Nuts	-	McMaster-Carr	91841A003
1	L1	2.2uH,8A,20mΩ	7.2mmx7mmx3mm	DELTA	MPO73-2R2IR
1	R8	Resistor,thick film, 0Ω	0805	ROHM	MCR10EZHZJ000
1	R9	Resistor,thick film, 0Ω	0603	ROHM	MCR03EZHZJ000
1	R13	Resistor,thick film,0Ω	1206	KOA	RM73Z2B000
1	R5	Resistor,thick film,1Ω, 5%	0805	ROHM	MCR10EZHZJ1R0
1	R6	Resistor,thick film,20Ω, 1%	0603	KOA	RK73H1JLTD20R0F
1	R4	Resistor,thick film,887Ω, 1%	0603	KOA	RK73H1J8870F
1	R1	Resistor,thick film,10kΩ, 1%	0603	KOA	RK73H1J1002F
1	R3	Resistor,thick film,1.5kΩ, 1%	0603	KOA	RK73H1J1501F
1	R2	Resistor,thick film,6.81kΩ, 1%	0603	KOA	RK73H1JLTD6811F
2	R11,R12	Resistor,thick film,49.9Ω, 1%	1206	KOA	RK73H2B49R9F
1	R16	Resistor,thick film,6.19kΩ, 1%	0603	KOA	RK73H1JLTD6191F
1	Q1	Dual N FET,20V,Q1=13.4mΩ,11nC,Q2=9.3mΩ,23nC	SO-8	IR	IRF9910PBF
1	U1	PWM Controller	SO-8	IR	IR3624MPBF
7	C3,C9, R7, R10, R14, R15	Not installed			

Table 1 – Complete Bill of Materials for IRPP3624-05A Reference Design

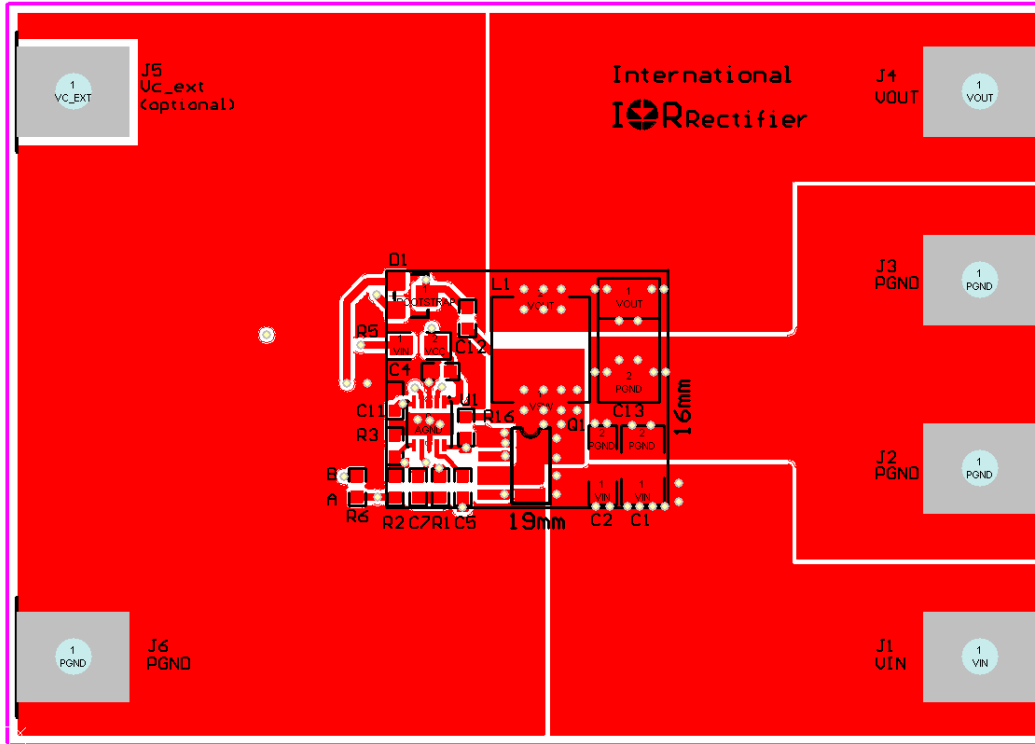

Figure 3a: IRPP3624-05A Reference Design top layer placement and layout.

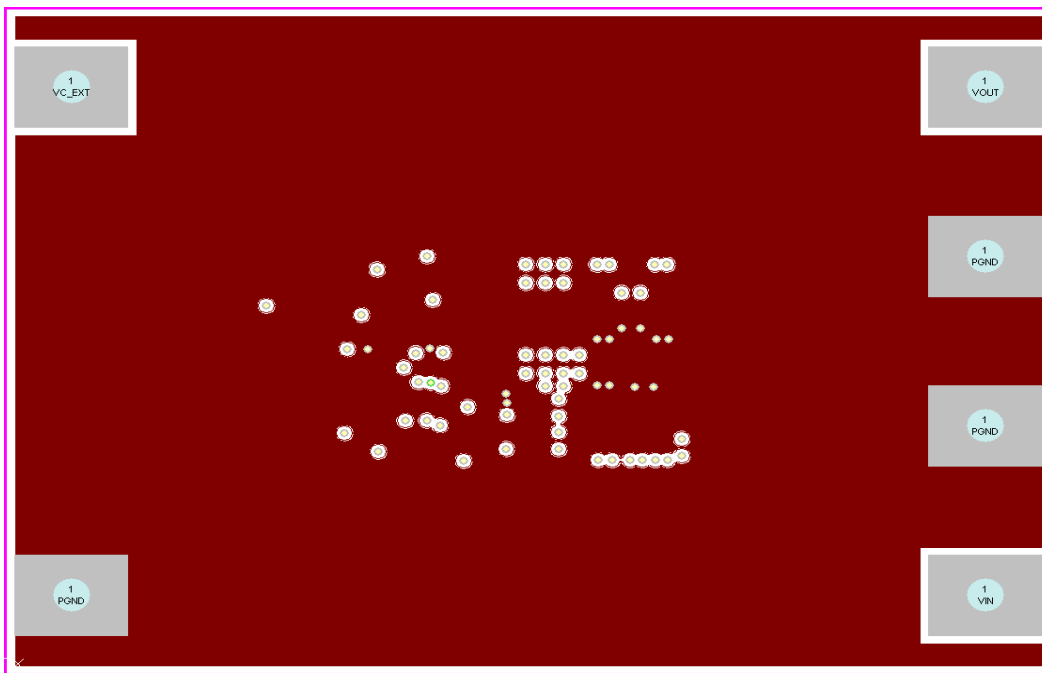

Figure 3b: IRPP3624-05A Reference Design mid-layer1 ground plane

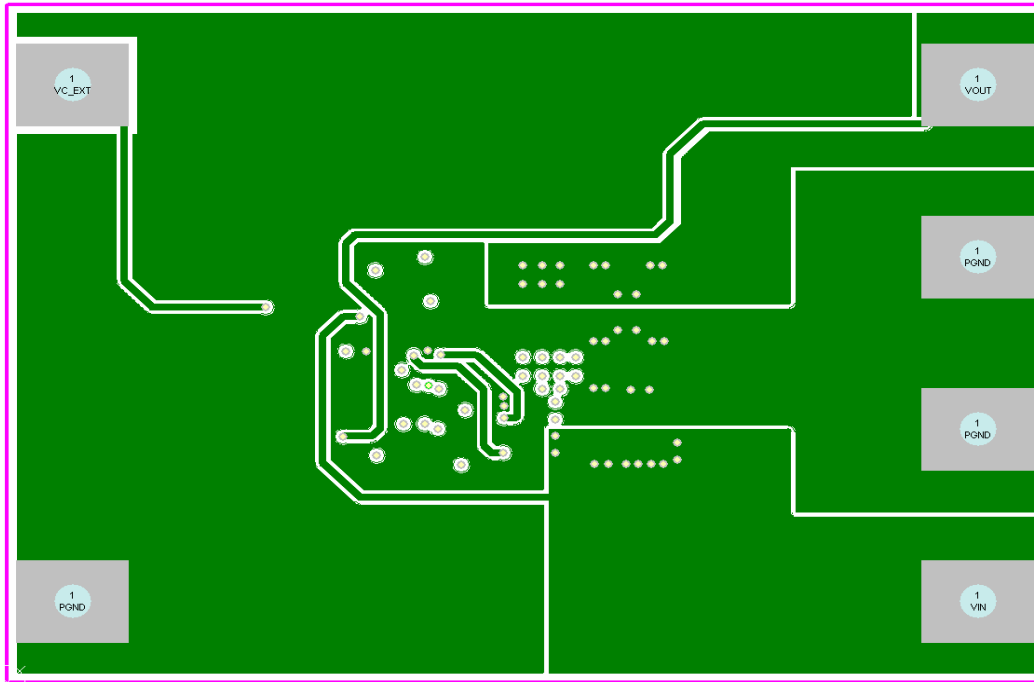

Figure 3c: IRPP3624-05A Reference Design mid-layer2 layout.

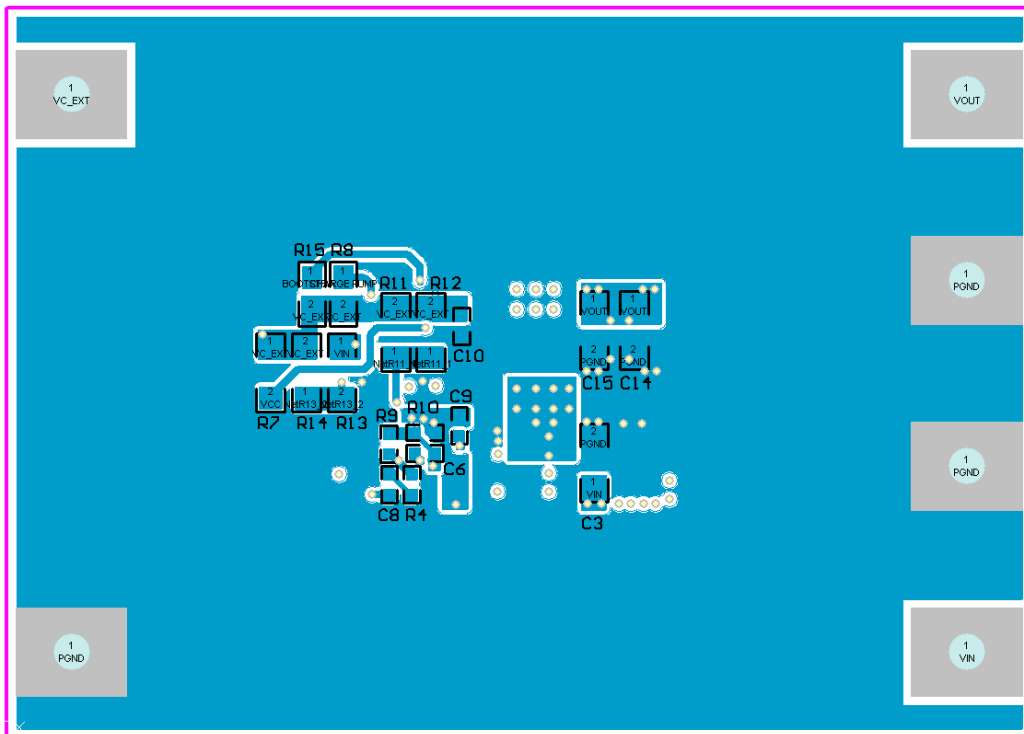

Figure 3d: IRPP3624-05A Reference Design bottom layer layout.

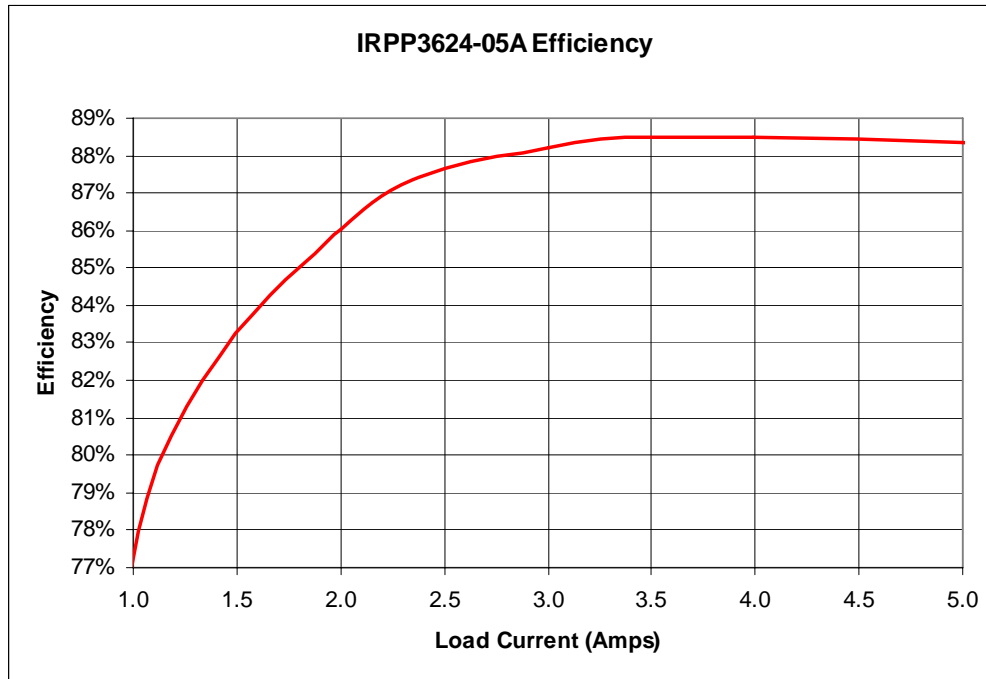

Figure 4a: IRPP3624-05A Reference Design Electrical Efficiency

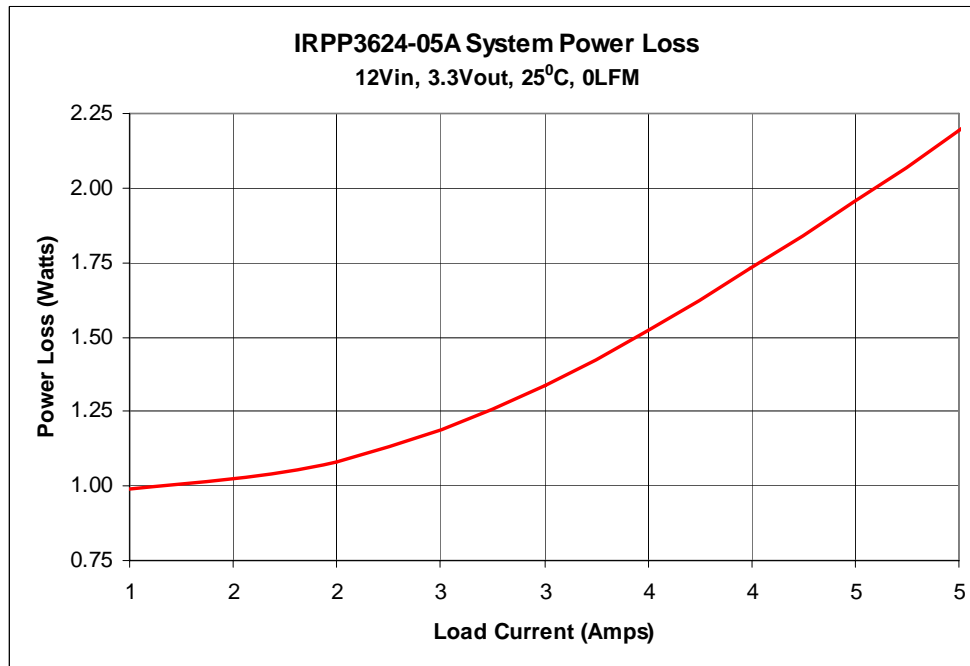

Figure 4b: IRPP3624-05A Reference Design Power Loss Curve

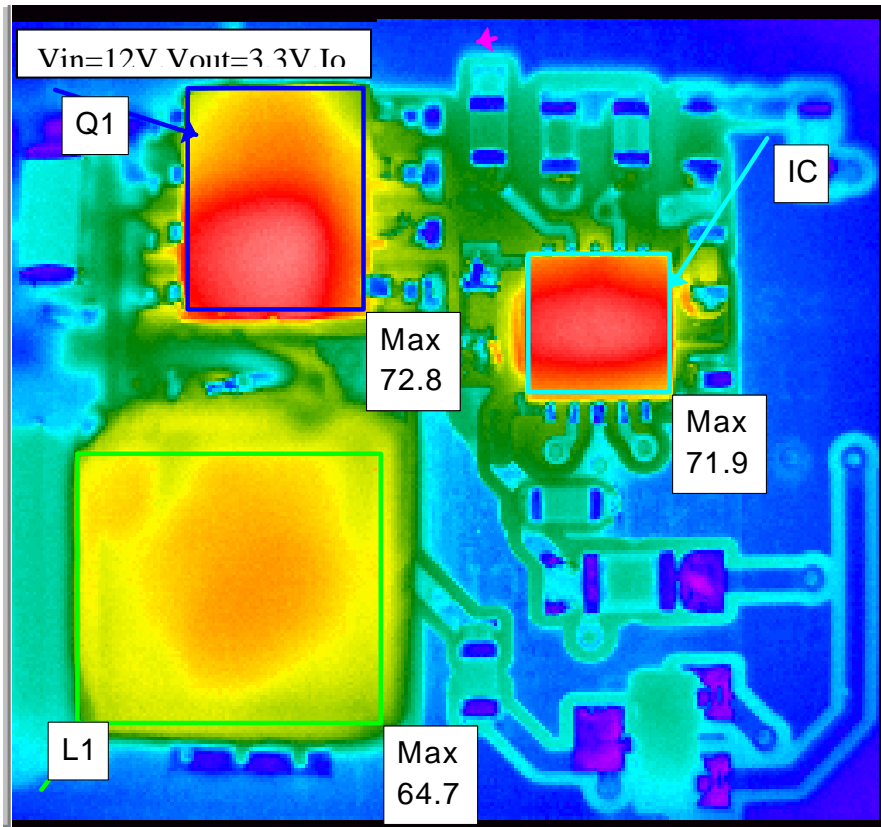

Figure 5: IRPP3624-05A Reference Design Thermograph at 5A load

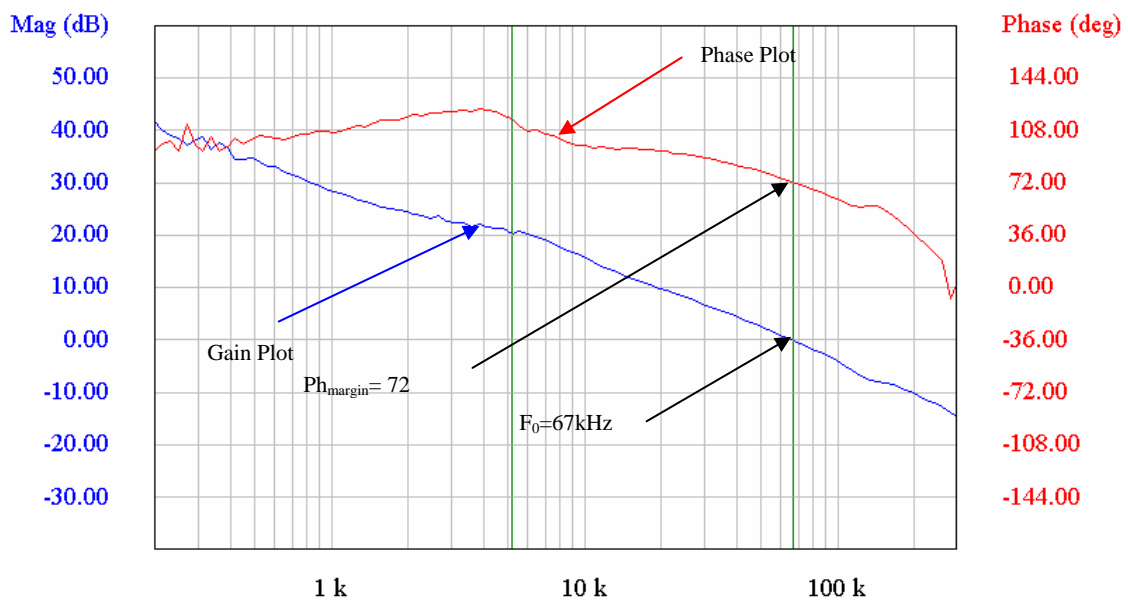

Figure 6: IRPP3624-05A Reference Design Bode Plot of the Control Loop at 5A load.

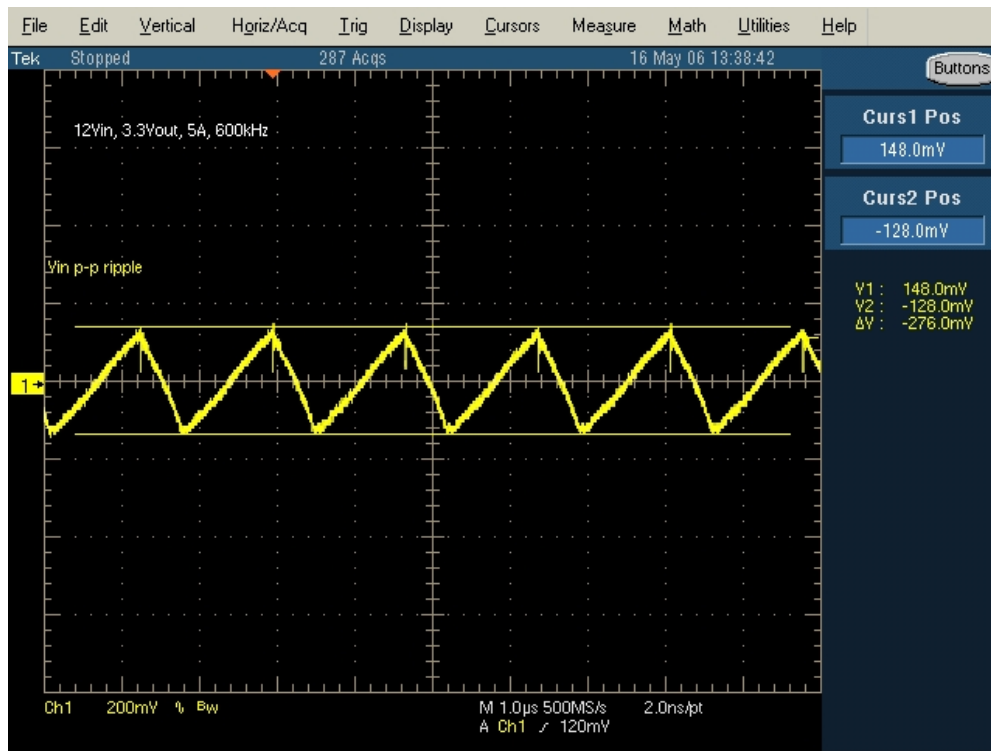

Figure 7: Input ripple, $I_o=5A$

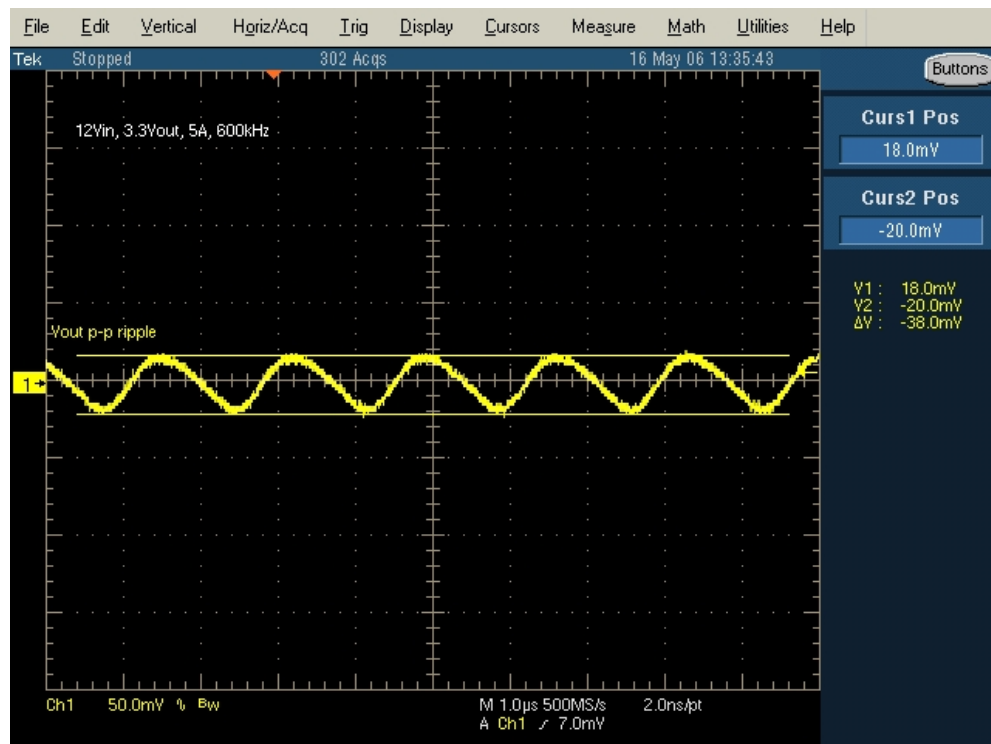

Figure 8: Output ripple, $I_o=5A$

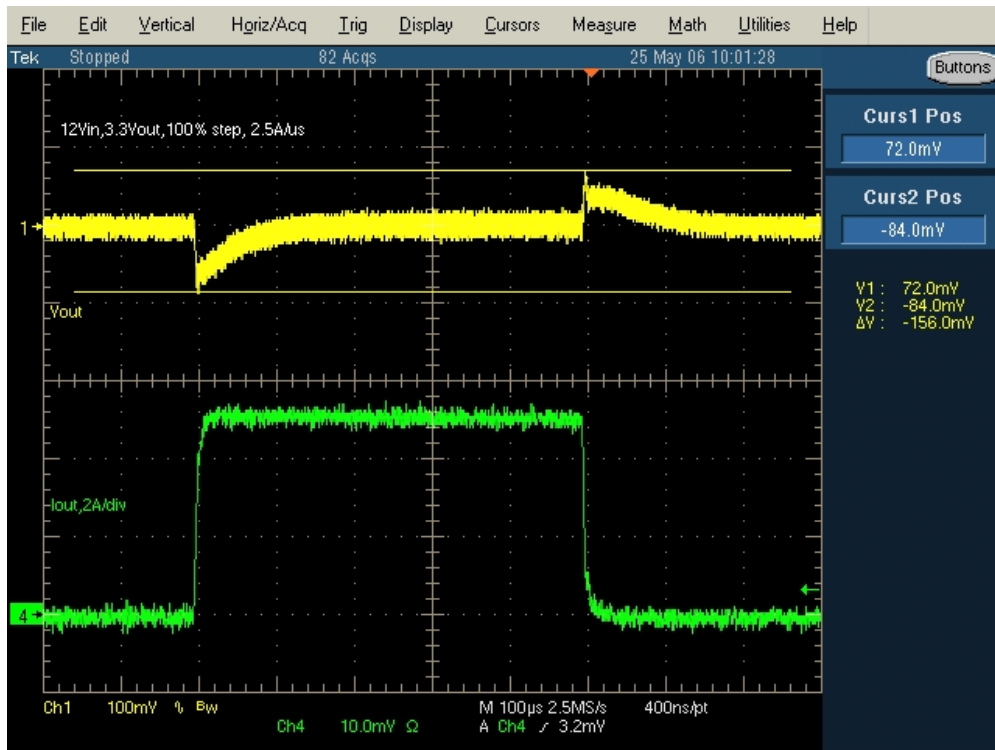

Figure 9: Output Voltage transients, load: 1A to 5A to 1A, $di/dt=2.5A/us$

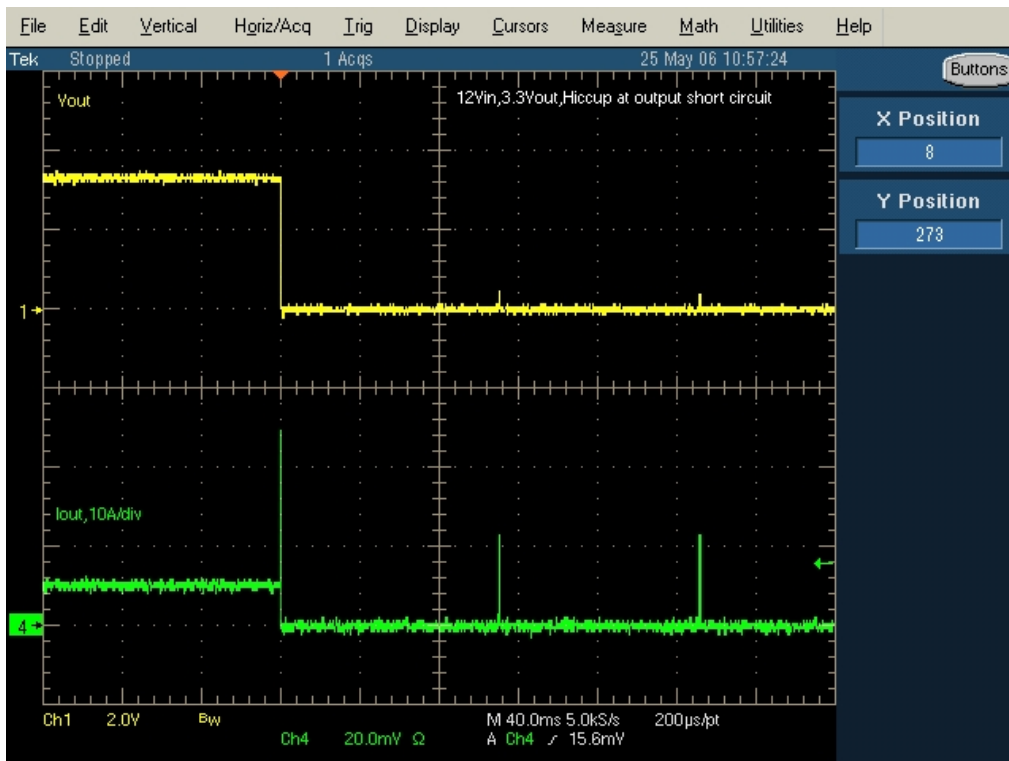

Figure 10: Hiccup mode, response to output short circuit

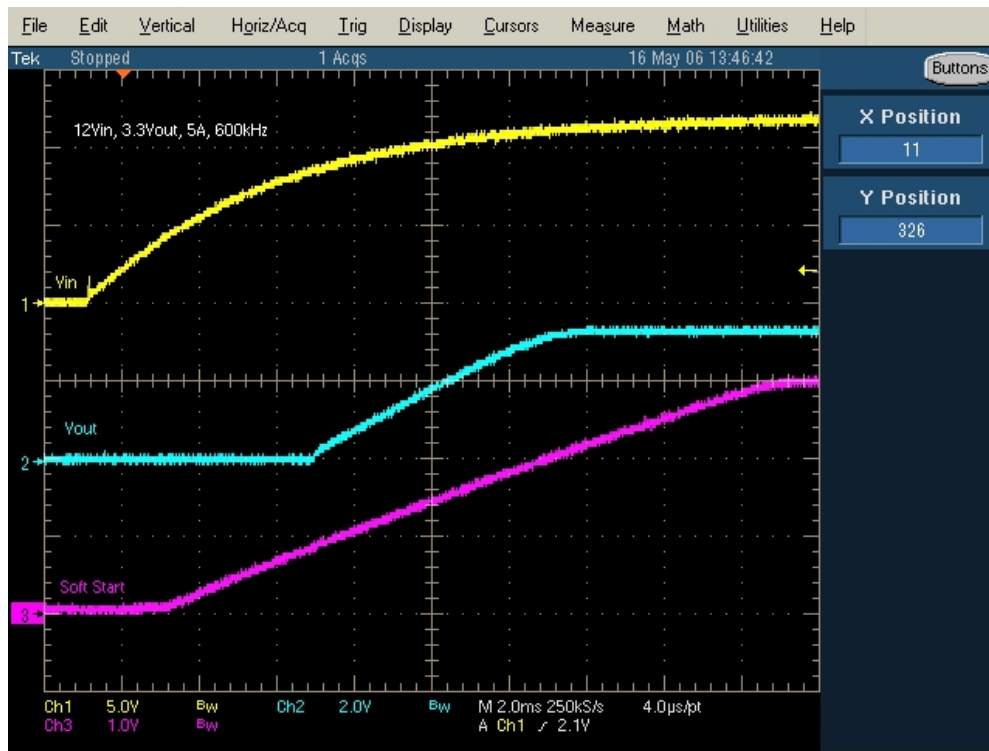

Figure 11: Power up. Ch1= V_{IN} , Ch2= V_{OUT} , Ch3=Soft Start

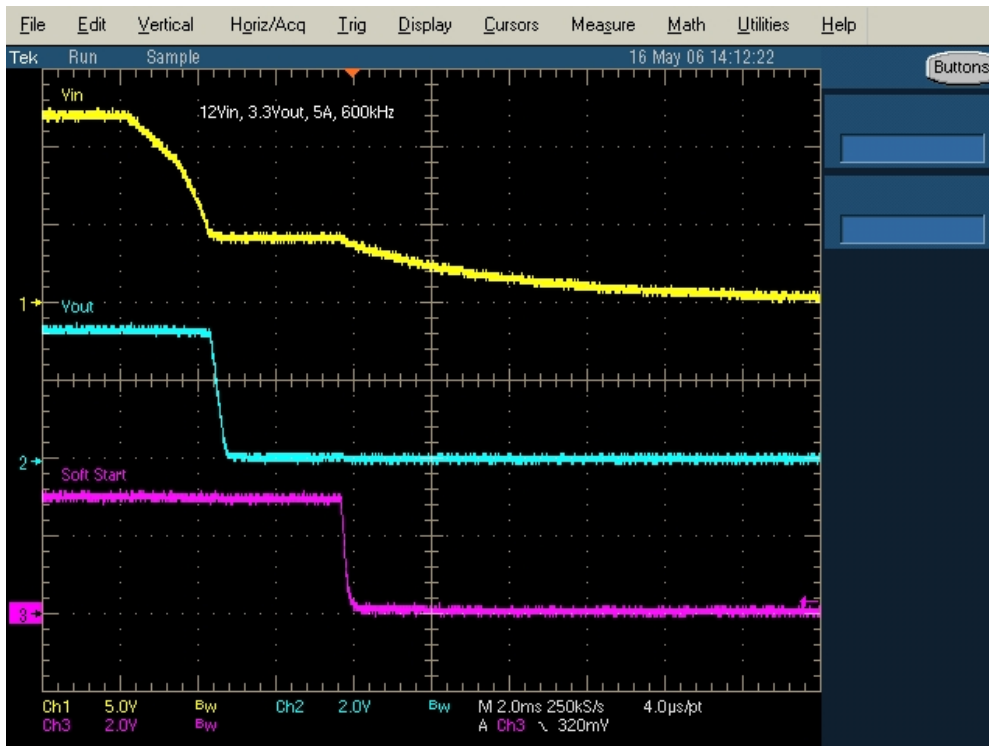

Figure 12: Power down. Ch1= V_{IN} , Ch2= V_{OUT} , Ch3=Soft Start

Part Number	Input Voltage	Output Voltage	Output Current	Switching Frequency	Power Semi BOM	Delivery Time	Comments
IRPP3624-05A	12V	3.3V	5A	600kHz	IR3624MPBF (MLPD-3x3) IRF8910PBF (Dual SO-8)	24 - 48 hrs	Standard Reference Design Fixed BOM
IRPP3624-12A	12V	1.8V	12A	600kHz	IR3624MPBF (MLPD-3x3) IRF7823PBF (SO-8) IRF7832ZPBF (SO-8)		

Table 2 – Complete IRPP3624-xxA Reference Design Selector Table