

# Packaging in T&R for SMD potentiometers

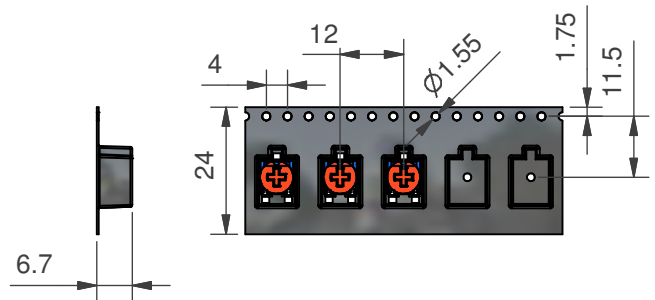
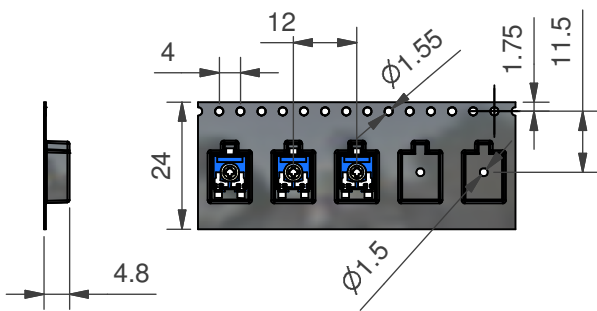

Potentiometers per reel:

**Without** thumbwheel: 1200  
(MOQ 4800, in multiples of 1200)

**With** thumbwheel "6030": 750  
(MOQ 5250, in multiples of 750)

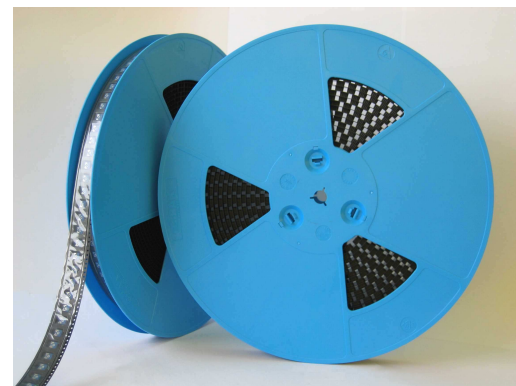
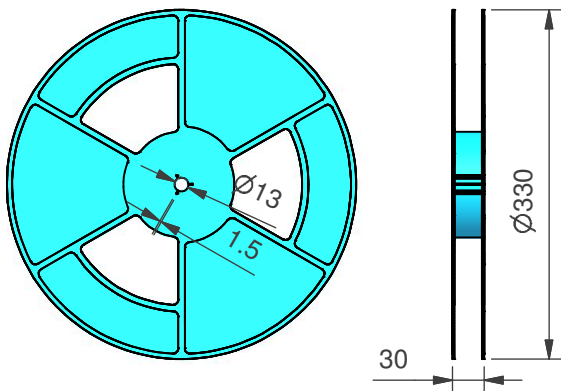
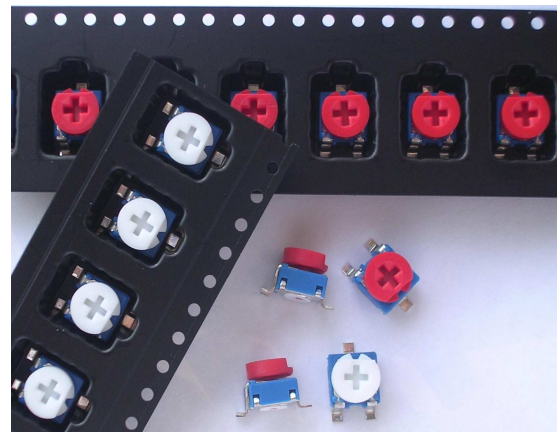
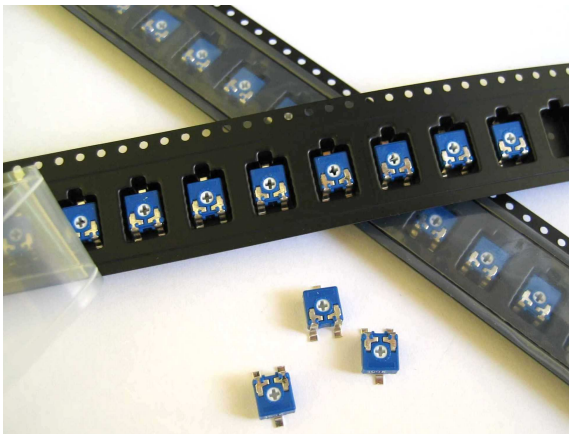

					Fecha	Nombre	 ARAGONESA DE COMPONENTES PASIVOS S.A.	Referencia Artículo
				Creado	19/2/04	LMA		
				Revisado				Revisión
				TOLERANCIA GENERAL		ESCALA	<b>CA6VSMD-T&amp;R</b>	Nº Plano
				Angular / Lineal				
				±1°		< 1 ±0,05		
						1..10 ±0,1		
						>10 ±0,15		
Estado	Cambios	Fecha	Nombre	REF. DOCUMENTO :				