

DC Power Relays

G9EJ-1-E

Compact DC Power Relays Capable of Switching 400 V 15 A DC loads



- Actualize a high capacity interruption through the function of extinction of magnetic arc by adopting high-efficiency magnetic circuit.
- Actualize improvement of inrush-withstand performance and a long-life by adopting Omron's own contact driving system.
- Actualize the power saving.
- Small and lightweight type.

Size: H31 mm × W27 mm × L44 mm, Weight: approx. 50 g



RoHS Compliant



Refer to the *Precautions* on page 4.

Model Number Structure

G9EJ-□-□-□-□-□-□
1 2 3 4 5 6

1. Number of Poles

1: 1 pole

4. Classification

E: High capacity

2. Contact Form

Blank: SPST-NO

5. Mounting shape

Blank: Upper bracket

3. Terminal Form

Blank: Tab terminal

6. Approved standards

UVD: UL, CSA, VDE approved standard type

Ordering Information

Models	Terminals		Contact form	Rated coil voltage	Model
	Coil terminals	Contact terminals			
Switching/current conduction models	Tab terminals #250	Tab terminals #250	SPST-NO	12 VDC 24 VDC	G9EJ-1-E-UVD

Ratings

● Coil

Rated voltage	Rated current	Coil resistance	Must-operate voltage	Must-release voltage	Maximum voltage (See note 3)	Power consumption
12 VDC	100 mA	120 Ω	60% max. of rated voltage	5% min. of rated voltage	130% of rated voltage (at 23°C within 10 minutes)	Approx. 1.2 W
24 VDC	50 mA	480 Ω				

Note: 1. The figures for the rated current and coil resistance are for a coil temperature of 23°C and have a tolerance of ±10%.

Note: 2. The figures for the operating characteristics are for a coil temperature of 23°C.

Note: 3. The figure for the maximum voltage is the maximum voltage that can be applied to the relay coil.

● Contacts

Item	Resistive load
Rated load	15 A at 400 VDC
Rated carry current	15 A
Maximum switching voltage	400 V
Maximum switching current	15 A

Characteristics

Item		G9EJ-1-E-UVD	
Contact resistance *1		100 MΩ max.	
Contact voltage drop		0.2 V max. (for a carry current of 15 A)	
Operate time *2		50 ms max.	
Release time *2		30 ms max.	
Insulation resistance *3	Between coil and contacts	1,000 MΩ min.	
	Between contacts of the same polarity	1,000 MΩ min.	
Dielectric strength	Between coil and contacts	2,500 VAC 1 min	
	Between contacts of the same polarity	2,500 VAC 1 min	
Impulse withstand voltage *4		4,500 V	
Vibration resistance	Destruction	10 to 55 to 10Hz, 0.75 mm single amplitude (Acceleration: 2.94 to 88.9 m/s ²)	
	Malfunction	10 to 55 to 10Hz, 0.75 mm single amplitude (Acceleration: 2.94 to 88.9 m/s ²)	
Shock resistance	Destruction	490 m/s ²	
	Malfunction	Energized	490 m/s ²
		Deenergized	98 m/s ²
Mechanical endurance *5		200,000 ops. min.	
Electrical endurance *6		400 VDC, 15 A, 10,000 ops. min.	
Short-time carry current		30 A (20 sec.)	
Overload switching		400 VDC, 30A, 100 ops. min.	
Maximum interruption current		50 A at 400 VDC (5 times)	
Reverse polarity interruption		-15 A at 400 VDC (1,000 times min.)	
Ambient operating temperature		-40 to 70°C (with no icing or condensation)	
Ambient operating humidity		5% to 85%	
Weight		Approx. 45 g	

Note: The above values are initial values at an ambient temperature of 23°C unless otherwise specified.

- *1. The contact resistance was measured with 1 A at 5 VDC using the voltage drop method.
- *2. Measurement conditions: With rated operating voltage applied (without diode), not including contact bounce.
- *3. The insulation resistance was measured with a 500 VDC megohmmeter.
- *4. The impulse withstand voltage was measured with a JEC-212 (1981) standard impulse voltage waveform (1.2 × 50 μs).
- *5. The mechanical endurance was measured at a switching frequency of 3,600 operations/hr.
- *6. The electrical endurance was measured at a switching frequency of 60 operations/hr.

Engineering Data

● Maximum Switching Capacity

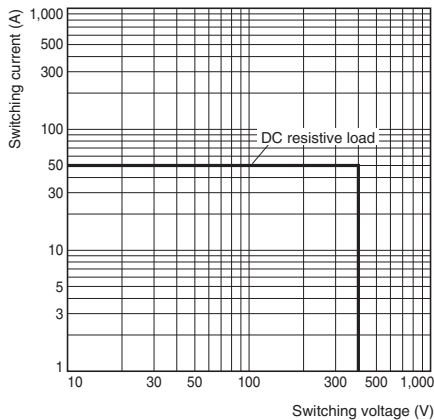

● Electrical Endurance (Switching Performance)

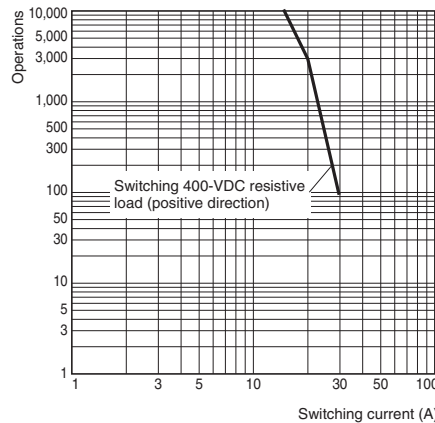

● Electrical Endurance (Interruption Performance)

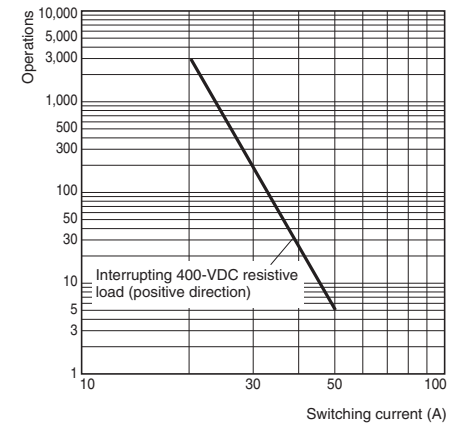

● Carry Current vs. Energizing Time

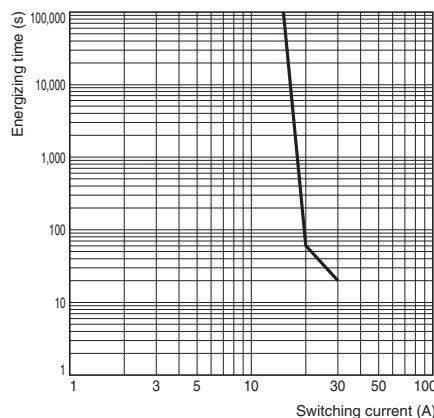

● Must-operate Voltage and Must-release Voltage Distributions (Number of Relays × Percentage of Rated Voltage)

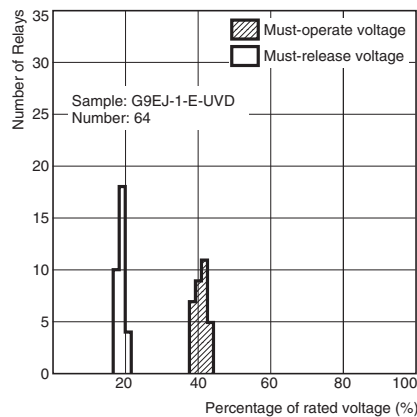

● Time Characteristic Distributions (Number of Contacts × Time (ms))

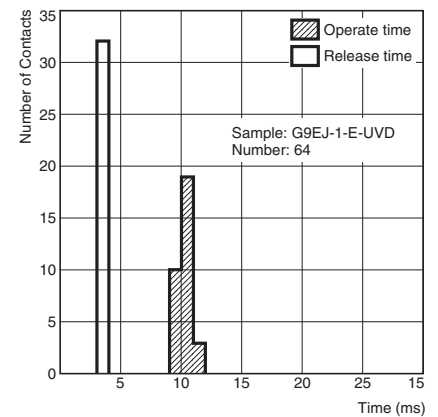

Vibration Malfunction

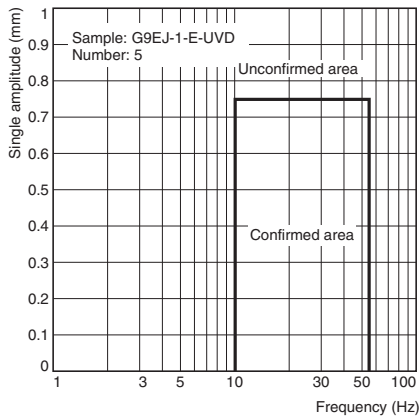

Vibration Resistance

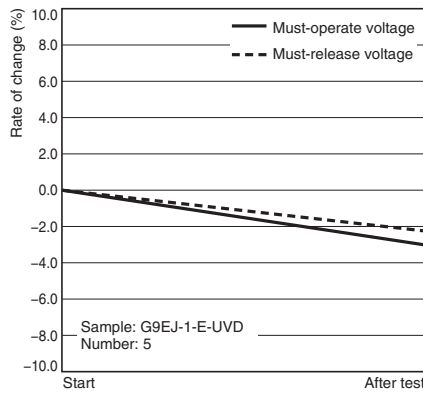

Characteristics were measured after applying vibration at a frequency of 10 to 55 Hz (single amplitude of 0.75 mm) to the test piece (not energized) for 2 hours each in 3 directions. The percentage rate of change is the average value for all of the samples

Shock Malfunction

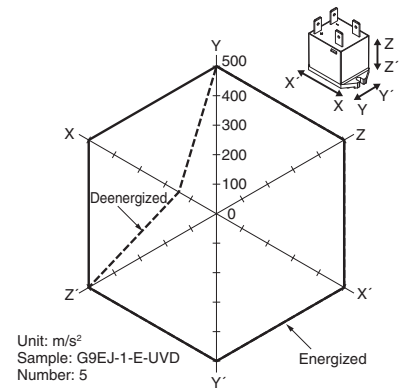

The value at which malfunction occurred was measured after applying shock to the test piece 3 times each in 6 directions along 3 axes.

Shock Resistance

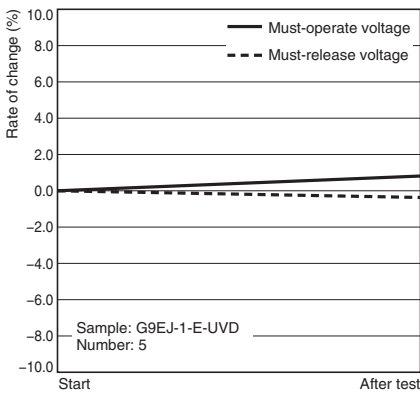

Characteristics were measured after applying a shock of $490 m/s^2$ to the test piece 3 times each in 6 directions along 3 axes. The percentage rate of change is the average value for all of the samples.

Dimensions (Unit: mm)

G9EJ-1-E-UVD

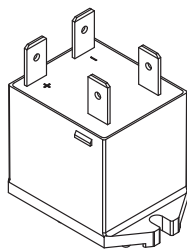

Dimension (mm)	Tolerance (mm)
10 or lower	± 0.3
10 to 50	± 0.5

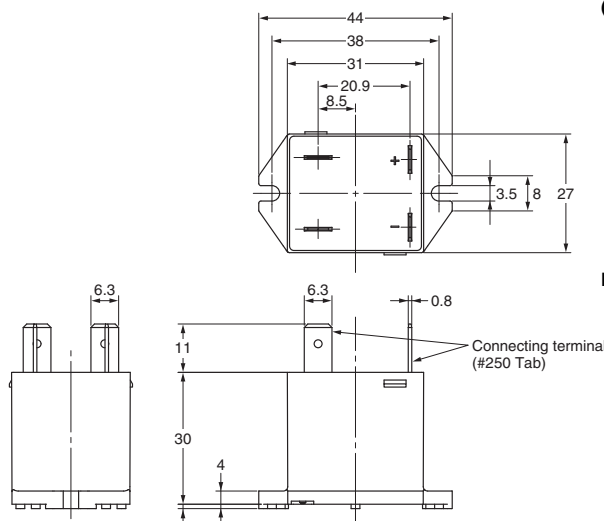

Mounting Hole Dimensions (TOP VIEW)

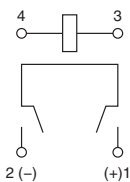

Note: Be sure to connect terminals with the correct polarity. Coils do not have polarity.

Mounting Hole Dimensions

Two, M3 or 3.5-dia. holes



Approved standards

UL Recognized: File No.E41515

CSA Certified: File No.LR31928 (pending)

VDE Certified: File No.40037488 (pending)

Model	Coil ratings	Contact ratings	Pollution level
G9EJ-1-E-UVD	12 V, 24 V	15 A, 500 VDC (Resistive)	2

Model	Coil ratings	Contact ratings	Pollution level
G9EJ-1-E-UVD	12 V, 24 V	15 A, 500 VDC (Resistive)	2

Precautions

WARNING

Take measures to prevent contact with charged parts when using the Relay for high voltages.



Precautions for Correct Use

Refer to the relevant catalog for common precautions.

- The G9EJ Relays' contacts have polarity.
Be sure to perform connections with the correct polarity.
If the contacts are connected with the reverse polarity, the switching characteristics specified in this document cannot be assured.
- Do not drop or disassemble this Relay. Not only may the Relay fail to meet the performance specifications, it may also result in damage, electric shock, or burning.
- Do not use these Relays in strong magnetic fields of 800 A/m or higher (e.g., near transformers or magnets). The arc discharge that occurs during switching may be bent by the magnetic field, resulting in flashover or insulation faults.
- This Relay is a device for switching high DC voltages. If it is used for voltages exceeding the specified range, it may not be possible to interrupt the load and burning may result. In order to prevent fire spreading, use a configuration in which the current load can be interrupted in the event of emergencies.
In order to ensure safety of the system, replace the Relay on a regular basis.
- If the Relay is used for no-load and/or minute load switching, the contact resistance may increase and so confirm correct operation under the actual operating conditions.
- With this Relay, if the rated voltage (or current) is continuously applied to the coil and contacts, and then turned OFF and immediately ON again, the coil temperature, and consequently the coil resistance, will be higher than usual. This means that the must operate voltage will also be higher than usual, exceeding the rated value ("hot start"). In this case, take the appropriate countermeasures, such as reducing the load current or restricting the energizing time or ambient operating temperature.
- The ripple percentage for DC relays can cause fluctuations in the must-operate voltage or humming. For this reason, reduce the ripple percentage in full-wave rectified power supply circuits by adding a smoothing capacitor. Ensure that the ripple percentage is less than 5%.
- Ensure that a voltage exceeding the specified maximum voltage is not continuously applied to the coil. Abnormal heating in the coil may shorten the lifetime of the insulation coating.
- Do not use the Relay at a switching voltage or current greater than the specified maximum values. Doing so may result in arc discharge interruption failure or burning due to abnormal heating in the contacts.
- The contact ratings are for resistive loads. The electrical endurance with inductive loads is inferior to that of resistive loads. Confirm correct operation under the actual operating conditions.
- Do not use the Relay in locations where water, solvents, chemicals, or oil may come in contact with the case or terminals. Doing so may result in deterioration of the case resin or abnormal heating due to corrosion or contamination of the terminals. Also, if electrolyte adheres to the output terminals, electrolysis may occur between the output terminals, resulting in corrosion of the terminals or wiring disconnections.
- Be sure to turn OFF the power and confirm that there is no residual voltage before replacing the Relay or performing wiring.
- The distance between crimp terminals or other conductive parts will be reduced and insulation properties will be lowered if wires are laid in the same direction from the contact terminals. Use insulating coverings, do not wire in the same direction, and take other measures as required to maintain insulation properties.
- Use either a varistor, or a diode plus Zener diode as a protective circuit against reverse surge in the relay coil. Using a diode alone will reduce the switching characteristics.

• Application examples provided in this document are for reference only. In actual applications, confirm equipment functions and safety before using the product.
• Consult your OMRON representative before using the product under conditions which are not described in the manual or applying the product to nuclear control systems, railroad systems, aviation systems, vehicles, combustion systems, medical equipment, amusement machines, safety equipment, and other systems or equipment that may have a serious influence on lives and property if used improperly. Make sure that the ratings and performance characteristics of the product provide a margin of safety for the system or equipment, and be sure to provide the system or equipment with double safety mechanisms.

Note: Do not use this document to operate the Unit.