

# Specification

## AX32X0

SSC		고객명
Drawn	Approval	Approval

# Contents

1. Part number of AX32X0
2. Outline dimensions
3. Characteristics of Acriche
4. Color spectrum, Ta=25°C
5. Current – Voltage characteristics, Ta=25°C
6. Voltage – Relative flux characteristics, Ta=25°C
7. Relative Flux – Junction temperature characteristics
8. Typical dome type radiation pattern, Ta=25°C
9. Acriche Binning structure graphical representation
10. Operating instructions of AX32X0
11. Recommended solder pad
12. Solder profile
13. Precaution for use
14. Handling of silicone resin for LEDs

# AX32X0

## Description

Acriche series is designed for AC source operation and high flux output applications. Acriche is a semi-permanent and environmental Friendly semiconductor lighting that can be used in AC without additional device.

Acriche's thermal management perform exceeds other power LED solutions. It incorporates state of the art SMD design and Thermal emission material. Acriche is ideal light sources for general illumination Applications.



# AX32X0

## Features

- Connect directly in AC power
- Power Saving
- Long Life Time
- Simple BOM
- Miniaturization
- Low thermal resistance
- SMT solderbility
- Lead Free product
- RoHS compliant

## Applications

- Architectural lighting
- Task lighting
- Decorative / Pathway lighting
- Household appliances

\* The appearance and specifications of the product can be changed for improvement without notice.

## Part number of AX32X0

### 1. Part Number form : A X<sub>1</sub> X<sub>2</sub> X<sub>3</sub> X<sub>4</sub> X<sub>5</sub>

X <sub>1</sub>	Color
W	Pure White
N	Warm White

X <sub>2</sub>	Acriche Series
1	-
2	-
3	A3

X <sub>3</sub>	LENS Type
2	Dome Type

X <sub>4</sub>	Operating Voltage [V]
0	100 / 110
1	-
2	220 / 230
3	-

X <sub>5</sub>	PCB Type
0	Emitter
1	-

### 2. Part Number of AX32X0

Part number	Operating voltage	Operating current
AW3200 / AN3200	100V/110V [RMS]	40mA [RMS]
AW3220 / AN3220	220V/230V [RMS]	20mA [RMS]

## Outline dimensions

### 1. AX3200

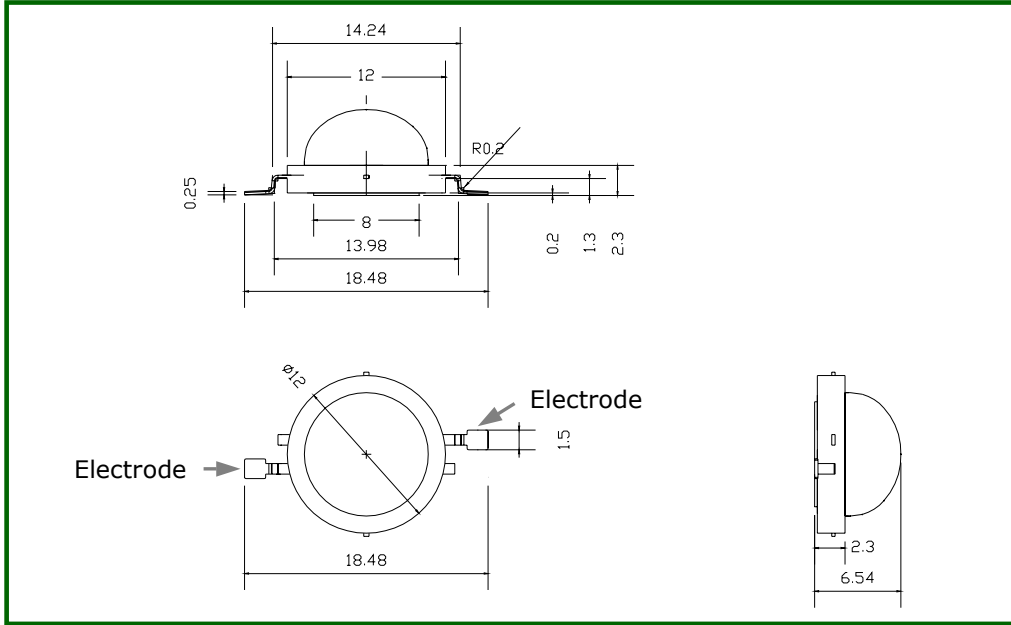

### 2. AX3220

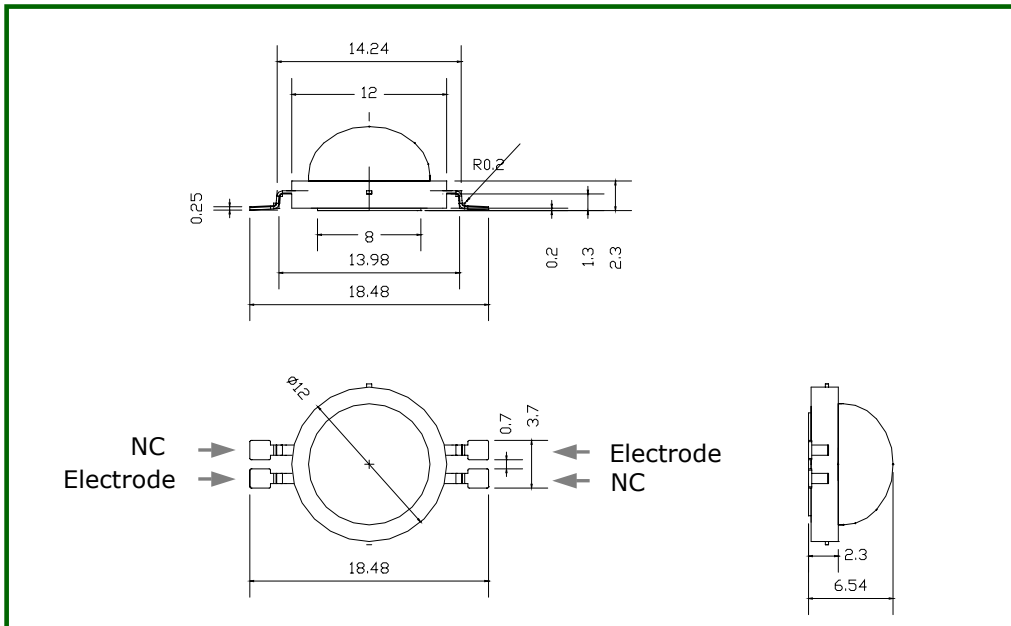

#### Notes :

- [1] All dimensions are in millimeters.
- [2] Scale : none
- [3] This drawing without tolerances are for reference only
- [4] Slug of package isn't connected to anode or cathode
- [5] NC pin isn't connected to electrode

Rev. 02  
May 2009

[www.ACRICHE.com](http://www.ACRICHE.com)

서식번호 : SSC-QP-7-07-25 (Rev.00)

## Characteristics of Acriche

### 1. AW3200

1-1 Electro-Optical characteristics at 100V/110V Ta=25°C

Parameter	Symbol	Value			Unit
		Min	Typ	Max	
Luminous Flux [1]	$\Phi_V$ [2]	-	215	-	lm
Illuminance [3]	$\Phi_I$	-	240	-	lx
Correlated Color Temperature [4]	CCT	-	6300	-	K
CRI	$R_a$	-	65	-	-
Operating Current	$I_{opt}$	-	40	-	mA [RMS]
Power Dissipation	$P_D$	3.3			W
Operating Frequency	Freq	50 / 60			Hz
View Angle	$2\theta$ 1/2	130			deg.

1-2 Absolute Maximum Ratings

Parameter	Symbol	Value	Unit
Operating Voltage	$V_{opt}$ [5]	115/127	V [RMS]
Power Dissipation	$P_D$	6.4	W
Junction Temperature	$T_j$	125	°C
Operating Temperature	$T_{opr}$	-40 ~ +85	°C
Storage Temperature	$T_{stg}$	-40 ~ +120	°C
ESD Sensitivity	-	±2,000V HBM	-

\*Notes :

- [1] Acriche series maintains a tolerance of ±10% on flux and power measurements.
- [2]  $\Phi_V$  is the total luminous flux output as measured with an integrated sphere.
- [3] Illuminance is measured at 50cm distance
- [4] Correlated Color Temperature is derived from the CIE 1931 Chromaticity diagram.  
CCT ±5% tester tolerance
- [5] 'Operating Voltage' doesn't indicate the maximum voltage which customers use, but it means tolerable voltage according to the voltage variation rate by one's country.  
It is recommended that the temperature of lead frame should be below 70 °C.

## Characteristics of Acriche

### 2. AN3200

1-1 Electro-Optical characteristics at 100V/110V Ta=25°C

Parameter	Symbol	Value			Unit
		Min	Typ	Max	
Luminous Flux [1]	$\Phi_V$ [2]	-	145	-	lm
Illuminance [3]	$\Phi_I$	-	160	-	lx
Correlated Color Temperature [4]	CCT	-	3000	-	K
CRI	$R_a$	-	80	-	-
Operating Current	$I_{opt}$	-	40	-	mA [RMS]
Power Dissipation	$P_D$	3.3			W
Operating Frequency	Freq	50 / 60			Hz
View Angle	$2\theta$ 1/2	130			deg.

1-2 Absolute Maximum Ratings

Parameter	Symbol	Value	Unit
Operating Voltage	$V_{opt}$ [5]	115/127	V [RMS]
Power Dissipation	$P_D$	6.4	W
Junction Temperature	$T_j$	125	°C
Operating Temperature	$T_{opr}$	-40 ~ +85	°C
Storage Temperature	$T_{stg}$	-40 ~ +120	°C
ESD Sensitivity	-	±2,000V HBM	-

\*Notes :

- [1] Acriche series maintains a tolerance of ±10% on flux and power measurements.
- [2]  $\Phi_V$  is the total luminous flux output as measured with an integrated sphere.
- [3] Illuminance is measured at 50cm distance
- [4] Correlated Color Temperature is derived from the CIE 1931 Chromaticity diagram.  
CCT ±5% tester tolerance
- [5] 'Operating Voltage' doesn't indicate the maximum voltage which customers use, but it means tolerable voltage according to the voltage variation rate by one's country.  
It is recommended that the temperature of lead frame should be below 70 °C.

## Characteristics of Acriche

### 4. AW3220

1-1 Electro-Optical characteristics at 220V/230V Ta=25°C

Parameter	Symbol	Value			Unit
		Min	Typ	Max	
Luminous Flux [1]	$\Phi_V$ [2]	-	215	-	lm
Illuminance [3]	$\Phi_I$	-	240	-	lx
Correlated Color Temperature [4]	CCT	-	6300	-	K
CRI	$R_a$	-	65	-	-
Operating Current	$I_{opt}$	-	20	-	mA [RMS]
Power Dissipation	$P_D$	3.3			W
Operating Frequency	Freq	50 / 60			Hz
View Angle	$2\theta$ 1/2	130			deg.

1-2 Absolute Maximum Ratings

Parameter	Symbol	Value	Unit
Operating Voltage	$V_{opt}$ [5]	253/265	V [RMS]
Power Dissipation	$P_D$	6.4	W
Junction Temperature	$T_j$	125	°C
Operating Temperature	$T_{opr}$	-40 ~ +85	°C
Storage Temperature	$T_{stg}$	-40 ~ +120	°C
ESD Sensitivity	-	±2,000V HBM	-

\*Notes :

- [1] Acriche series maintains a tolerance of ±10% on flux and power measurements.
- [2]  $\Phi_V$  is the total luminous flux output as measured with an integrated sphere.
- [3] Illuminance is measured at 50cm distance
- [4] Correlated Color Temperature is derived from the CIE 1931 Chromaticity diagram.  
CCT ±5% tester tolerance
- [5] 'Operating Voltage' doesn't indicate the maximum voltage which customers use, but it means tolerable voltage according to the voltage variation rate by one's country.  
It is recommended that the temperature of lead frame should be below 70 °C.



## Characteristics of Acriche

### 5. AN3220

1-1 Electro-Optical characteristics at 220V/230V Ta=25°C

Parameter	Symbol	Value			Unit
		Min	Typ	Max	
Luminous Flux [1]	$\Phi_V$ [2]	-	145	-	lm
Illuminance [3]	$\Phi_I$	-	160	-	lx
Correlated Color Temperature [4]	CCT	-	3000	-	K
CRI	$R_a$	-	80	-	-
Operating Current	$I_{opt}$	-	20	-	mA [RMS]
Power Dissipation	$P_D$	3.3			W
Operating Frequency	Freq	50 / 60			Hz
View Angle	$2\theta$ 1/2	130			deg.

1-2 Absolute Maximum Ratings

Parameter	Symbol	Value	Unit
Operating Voltage	$V_{opt}$ [5]	253/265	V [RMS]
Power Dissipation	$P_D$	6.4	W
Junction Temperature	$T_j$	125	°C
Operating Temperature	$T_{opr}$	-40 ~ +85	°C
Storage Temperature	$T_{stg}$	-40 ~ +120	°C
ESD Sensitivity	-	±2,000V HBM	-

\*Notes :

- [1] Acriche series maintains a tolerance of ±10% on flux and power measurements.
- [2]  $\Phi_V$  is the total luminous flux output as measured with an integrated sphere.
- [3] Illuminance is measured at 50cm distance
- [4] Correlated Color Temperature is derived from the CIE 1931 Chromaticity diagram.  
CCT ±5% tester tolerance
- [5] 'Operating Voltage' doesn't indicate the maximum voltage which customers use, but it means tolerable voltage according to the voltage variation rate by one's country.  
It is recommended that the temperature of lead frame should be below 70 °C.

## Color spectrum, Ta=25°C

### 1. Pure white

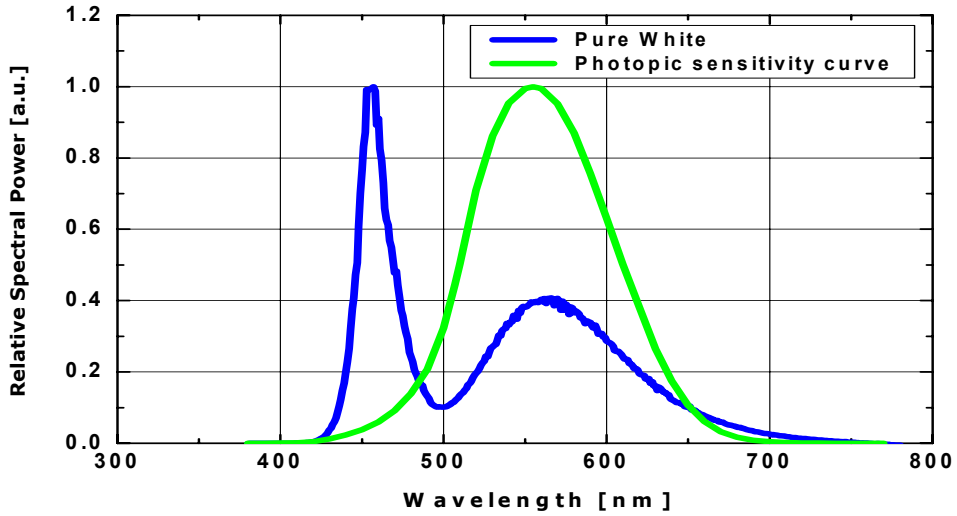

### 2. Warm white

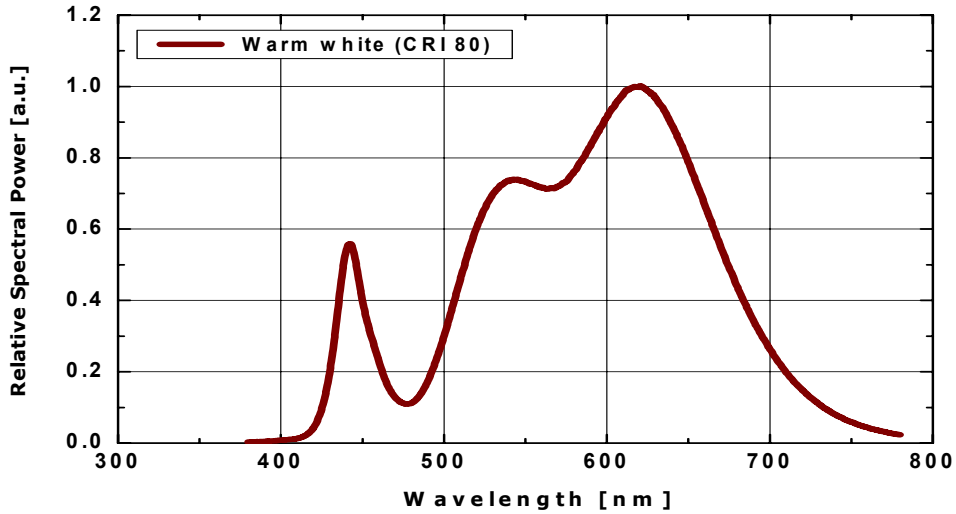

**Current – Voltage characteristics, Ta=25°C**

**1. AX3200 with external resistor @100V**

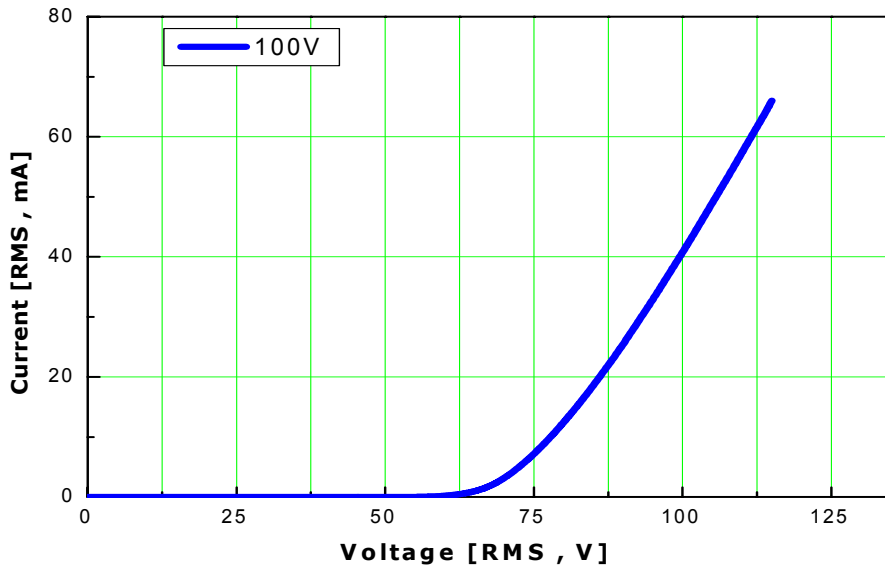

**2. AX3200 with external resistor @110V**

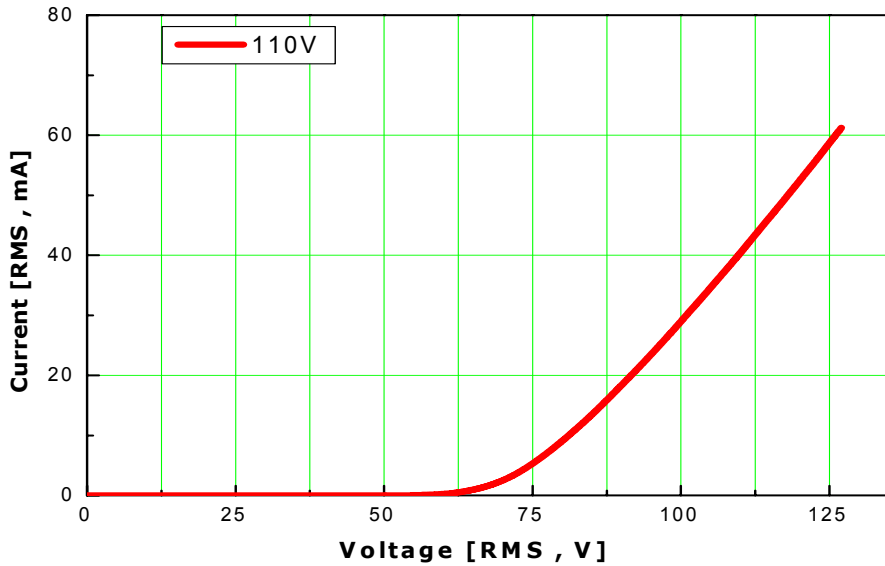

**Current – Voltage characteristics, Ta=25°C**

**3. AX3220 with external resistor @220V**

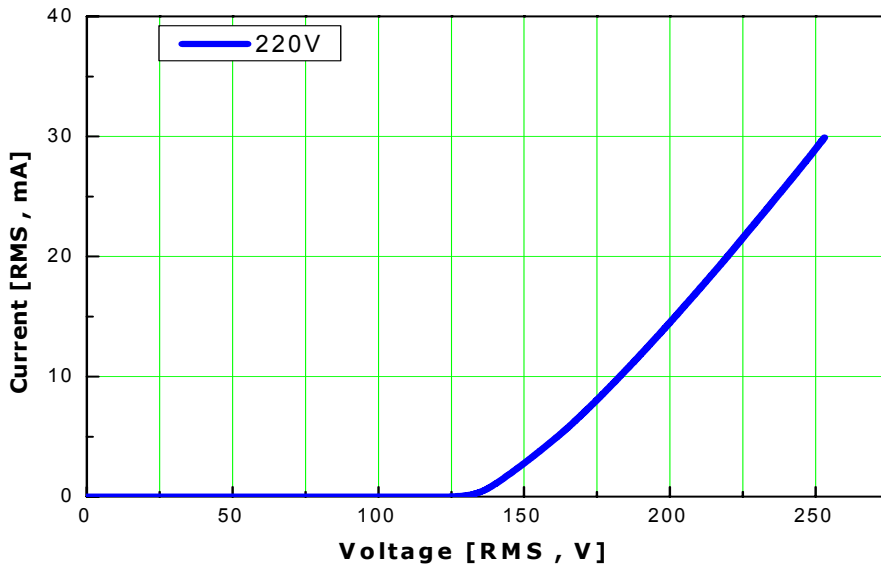

**4. AX3220 with external resistor @230V**

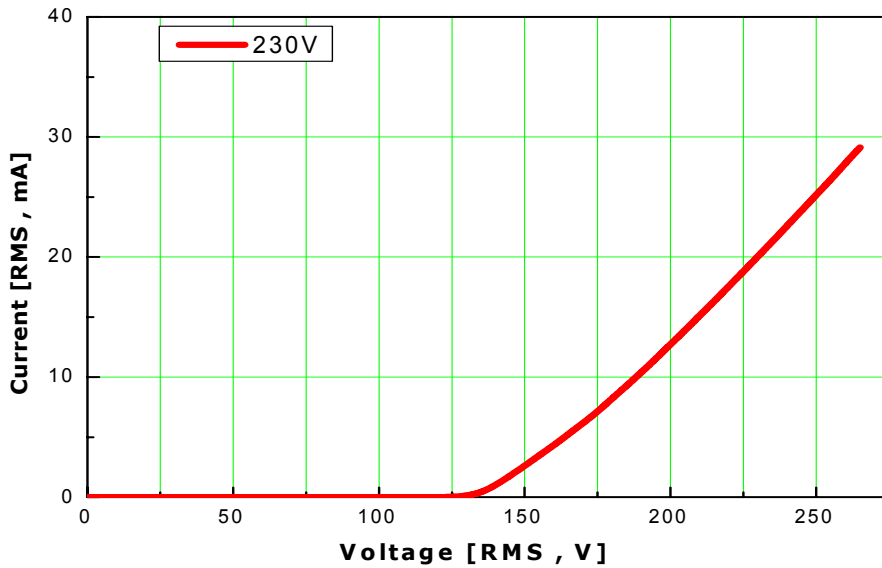

**Voltage – Relative flux characteristics, Ta=25°C**

**1. AX3200 with external resistor @100V**

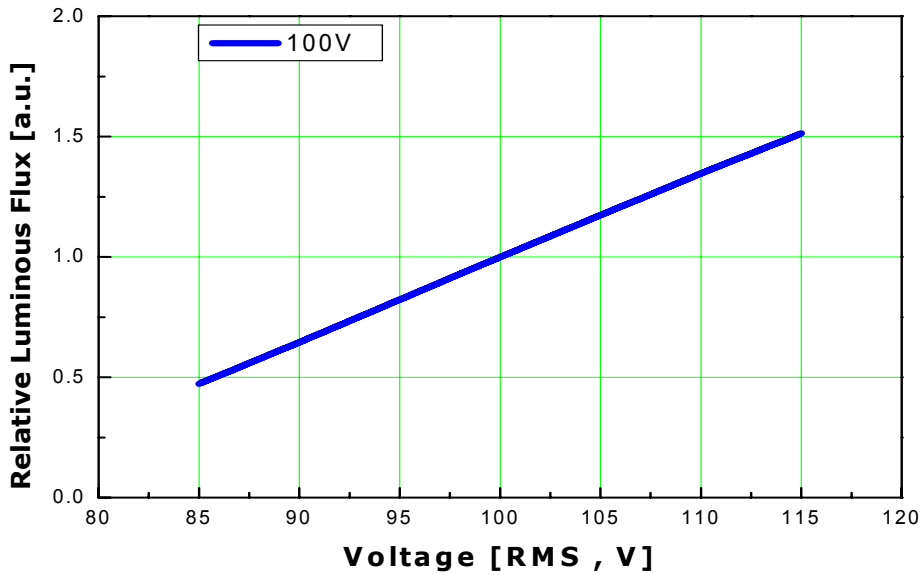

**2. AX3200 with external resistor @110V**

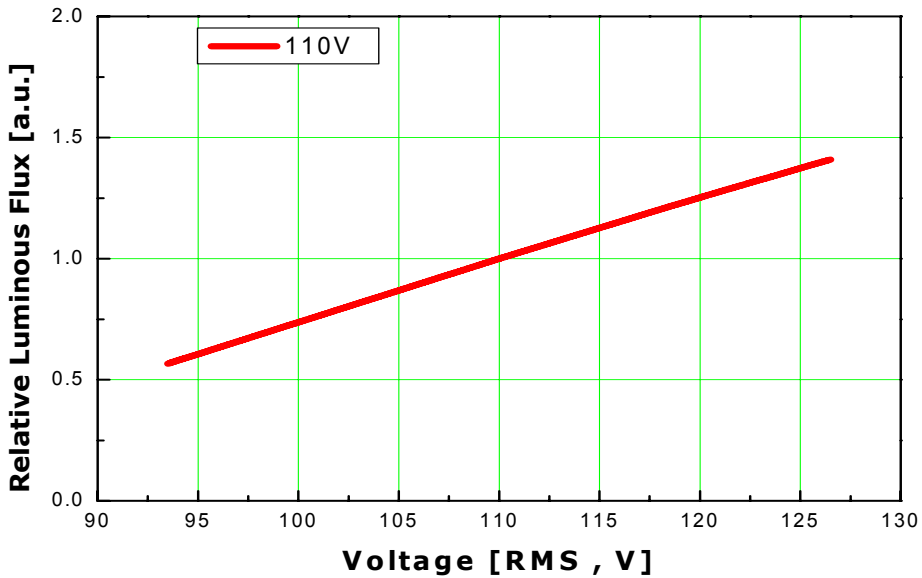

**Voltage – Relative flux characteristics, Ta=25°C**

**3. AX3220 with external resistor @220V**

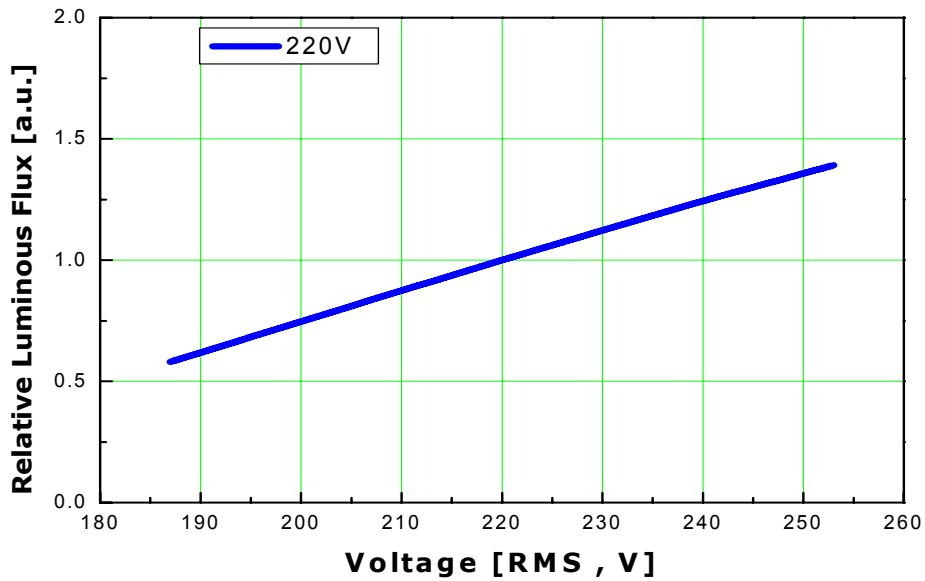

**4. AX3220 with external resistor @230V**

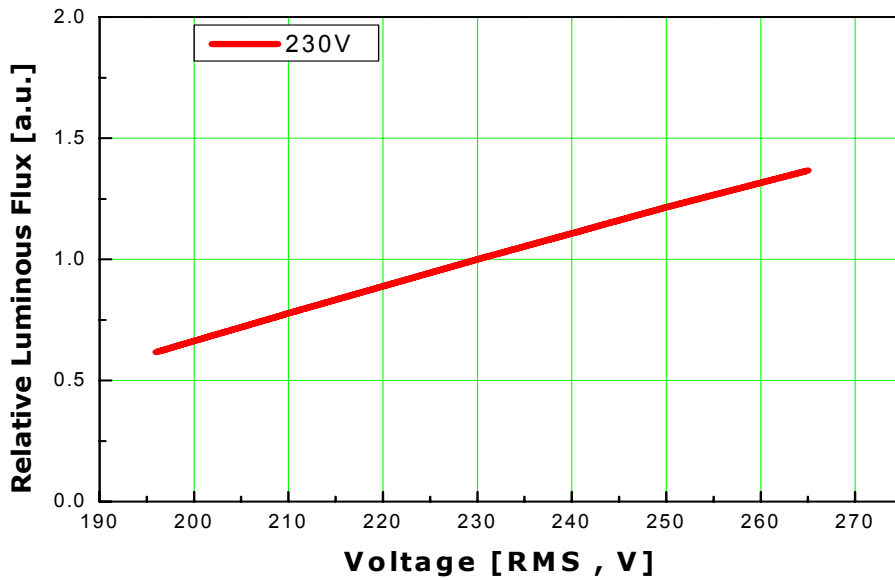

## Relative Flux – Junction temperature characteristics

### 1. AX32X0

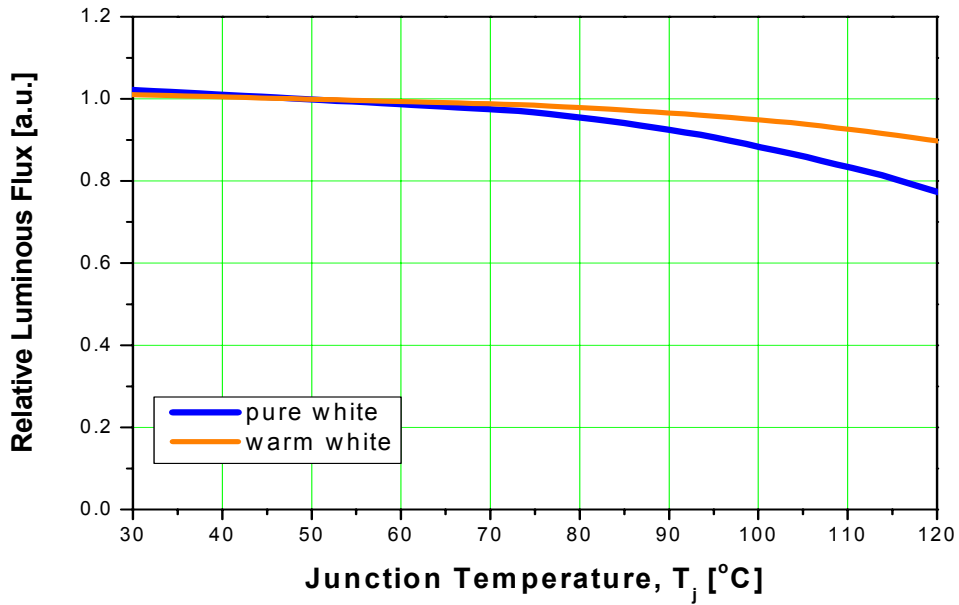

## Typical dome type radiation pattern, $T_a=25^\circ\text{C}$

### 1. AX32X0

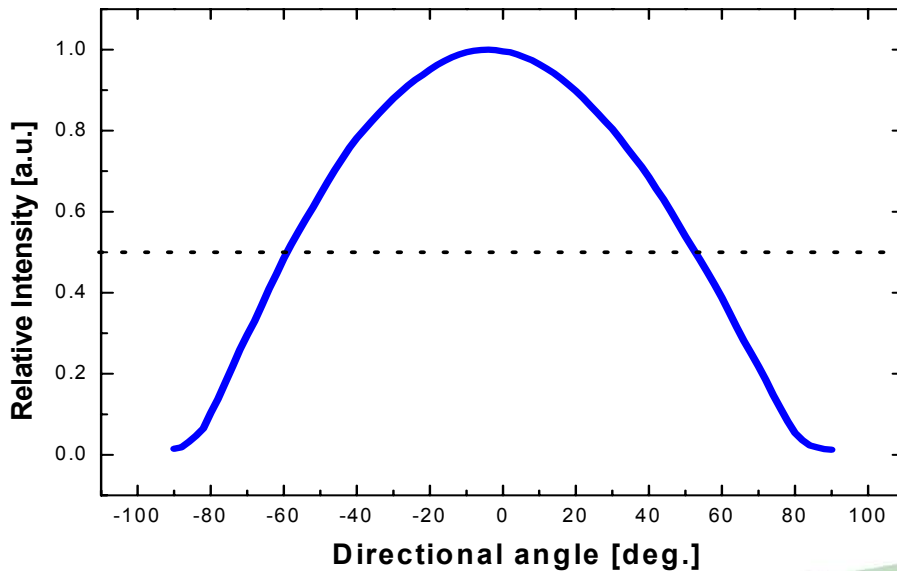

## Acriche Binning structure graphical representation

### 1. AX32X0

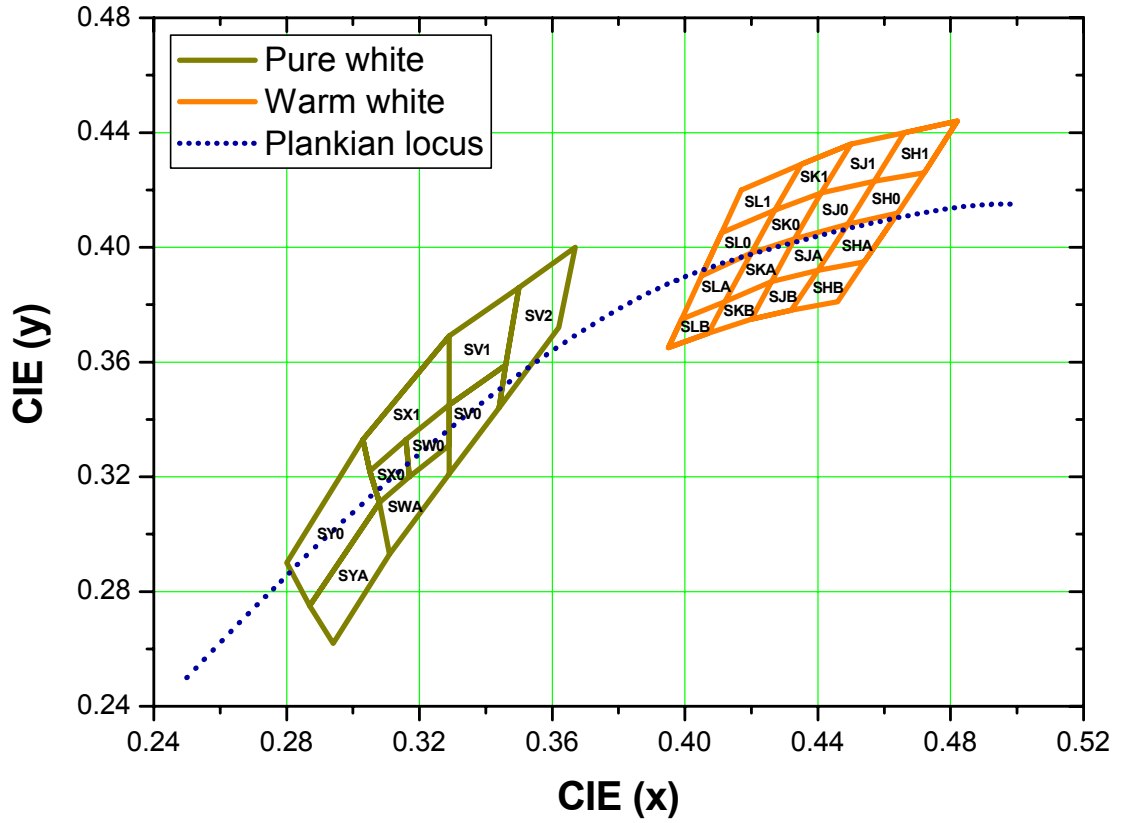

\*Notes : For more detail Acriche binning, see the Acriche Binning and Labeling document.



## Operating instructions of AX32X0

### 1. Operating circuit

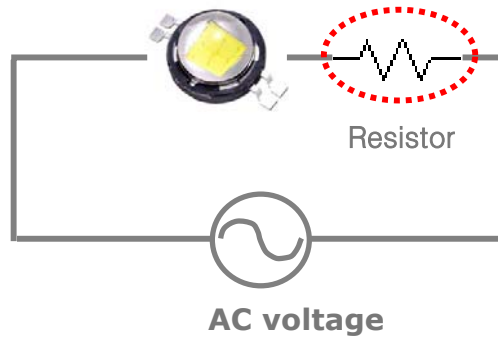

### 2. Resistor sheet

VF Bin	AX3200			AX3220		
	Driving current : 40mA [RMS]			Driving current : 20mA [RMS]		
	Resistor value			Resistor value		
	100V	110V	120V	220V	230V	240V
<b>A</b>	300Ω	500Ω	750Ω	2.2kΩ	2.6kΩ	3kΩ
<b>B</b>	250Ω	450Ω	700Ω	1.9kΩ	2.35kΩ	2.75kΩ
<b>C</b>	200Ω	400Ω	650Ω	1.63kΩ	2.1kΩ	2.55kΩ
<b>D</b>	-	350Ω	600Ω	1.36kΩ	1.85kΩ	2.3kΩ

Notes :

- [1] Acriche must be used with resistance certainly.
- [2] AW3200/AN3200 may be driven at maximum rated current of 40mA [RMS], AW3220/AN3220 may be driven at maximum rated current of 20m [RMS].
- [3] The tolerance of current is  $\pm 10\%$  on each resistance rank.
- [4] When the resistance is used, Check the rated power of resistance. Apply the proper resistance  
The rated power = operating current<sup>2</sup> X resistance

## Operating instructions of AX32X0

### 3. Operating temperature



**Surface Temperature ( $T_s$ )**

Parameter	Value	Unit
$R\theta_{jS}$	6 ~ 7	$^{\circ}\text{C}/\text{W}$
$T_j \text{ max}$	125	$^{\circ}\text{C}$
$T_s \text{ max}$	100	$^{\circ}\text{C}$

### 4. Thermal modeling

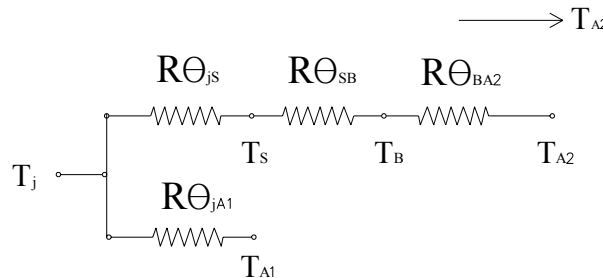
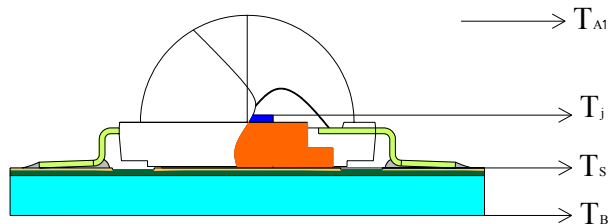

Notes :

- [1] Acriche must be used with proper heat management.
- [2] It is recommended that the temperature of board should be below  $70^{\circ}\text{C}$ .
- [3] For more information, refer to Z Power led Thermal Management Guide.  
([www.essc.co.kr/HOMEPAGE/home\\_kor/product/spec/thermal.pdf](http://www.essc.co.kr/HOMEPAGE/home_kor/product/spec/thermal.pdf))

## Operating instructions of AX32X0

### 5. Heat sink

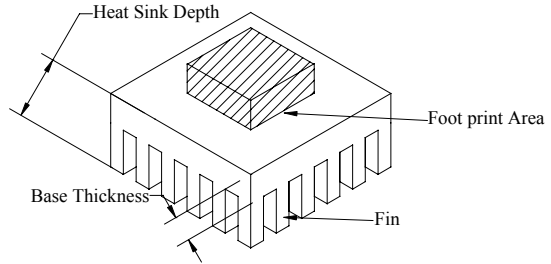

Specification & Size	$T_B(^{\circ}C)$	$R_{\theta_{BA}}(^{\circ}C / W)$
Size : 44 x 44 mm S : 7mm $T_B$ : 4mm, $D_H$ : 22.mm $F_H$ : 18mm      N : 7ea Footprint: 745mm <sup>2</sup> Power Dissipation:4W	73.8	10

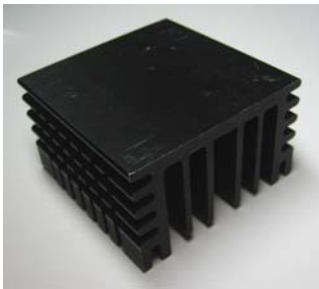

Specification & Size	$T_B(^{\circ}C)$	$R_{\theta_{BA}}(^{\circ}C / W)$
Size : 50 x 50 mm S : $T_B$ :      mm, $D_H$ : 25 mm $F_H$ :      mm      N : Footprint: 745mm <sup>2</sup> Power Dissipation:4W	56.2	5

## Recommended solder pad

### 1. Solder pad

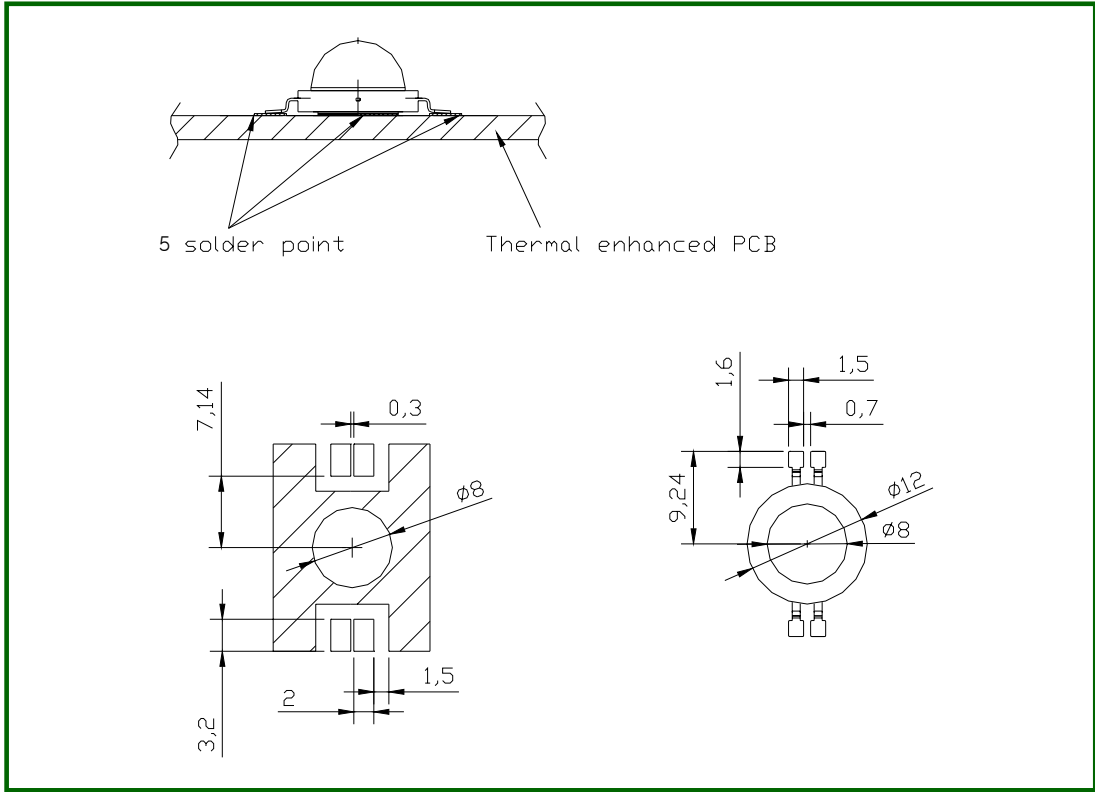

### 2. Solder paste pattern

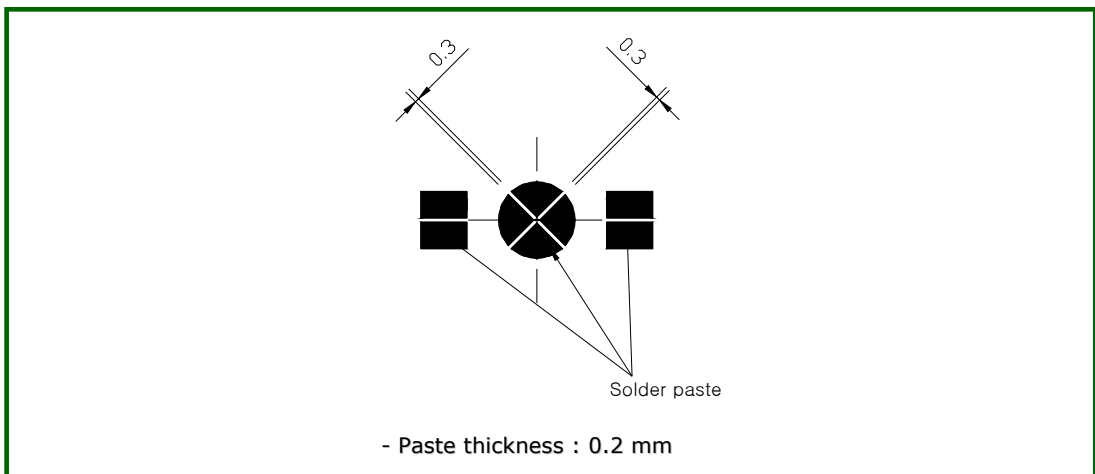

## Solder profile

### 1. Reflow solder conditions / profile

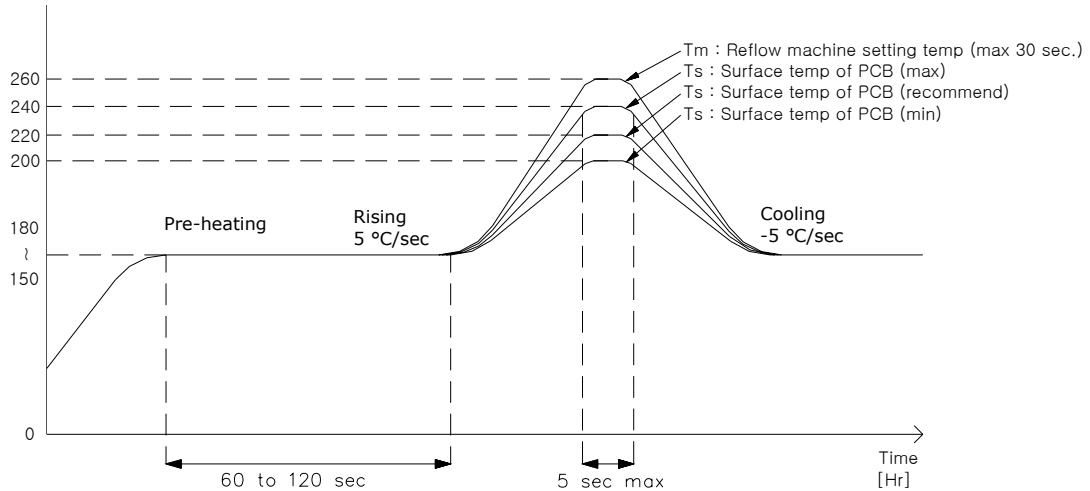

### 2. Hand Solder conditions

- 2-1 Lead : Not more than 3 seconds @MAX280°C
- 2-2 Slug : Use a thermal-adhesives

#### \* Caution

- [1] Reflow soldering should not be done more than one time.
- [2] Repairing should not be done after the LEDs have been soldered. When repairing is unavoidable, suitable tools have to be used.
- [3] Die slug is to be soldered.
- [4] When soldering, do not put stress on the LEDs during heating.
- [5] After soldering, do not warp the circuit board.
- [6] Recommend to use a convection type reflow machine with 7 ~ 8 zones.

## Precaution for use

- [1] Acriche series run on high voltage such as 110 V or 220 V.
- [2] Please don't touch the PCB surface, which has built-in terminals and chips, with your hands or metals, while Acriche series is running.
- [3] Please don't add or change wires, while Acriche series is running.

## Handling of silicone resin for LEDS

- [1] Acriche series is encapsulated by silicone resin for the highest flux efficiency.
- [2] Notes for handling of Silicone resin Acriche series.
- [3] Avoid touching silicone resin parts especially by sharp tools such as Pincette (Tweezers).
- [4] Avoid leaving fingerprints on silicone resin parts.
- [5] Dust sensitivity silicone resin need containers having cover for storage.
- [6] When populating boards in SMT production, there are basically no restrictions regarding the form of the pick and place nozzle, except that mechanical pressure on the surface of the resin must be prevent.
- [7] Please do not force over 3000 gf impact or pressure diagonally on the silicon lens. It will cause fatal damage of this product.
- [8] Please do not recommend to cover the silicone resin of the Acriche series with other resin (epoxy, urethane, etc).