



ANGLE	CODE
50°	3B50D

LED Type



BOX QUANTITI	288 P C S
BOX SIZE	36*33*18 cm
BOX WEIGHT	6,950 Kg

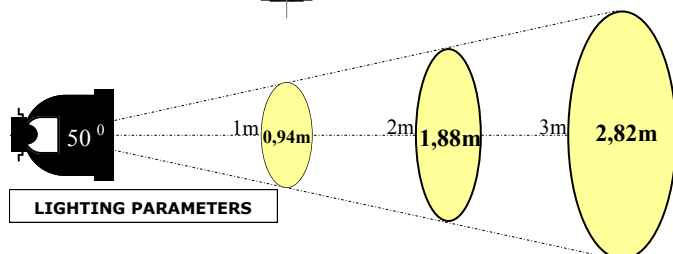
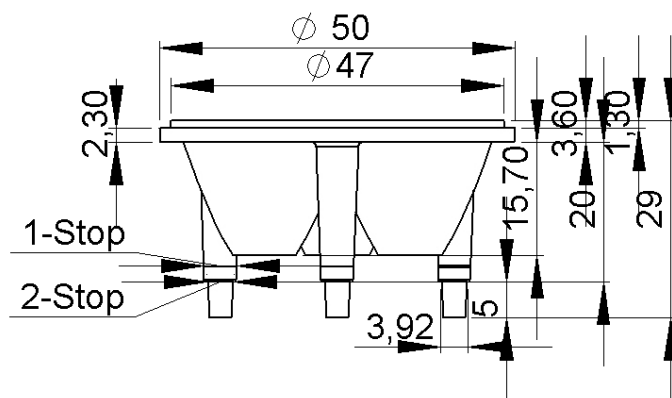
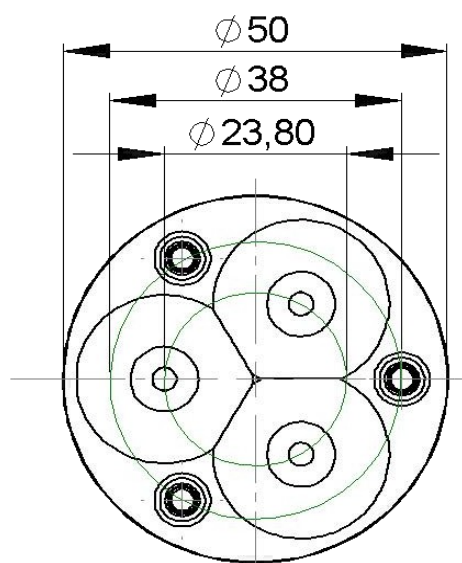
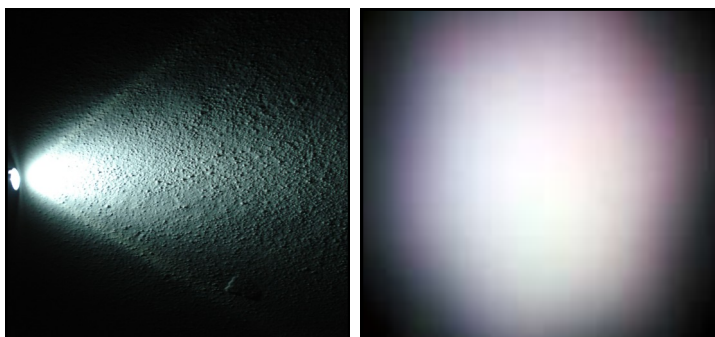

TURLENS USE : Street Lighting , Office Lighting , Home Lighting , Stage Lighting , Architectural Lighting , Down Light Lighting , Decorative Lighting

Lens INFO

Lens Material : Optical Grade Best Available Optical Efficiency

Lens Material : with high UV & Temperature Resistance -40°C ~ + 100°C

Lens Material : Light Transmittance High Productivity with 2mm Thickness

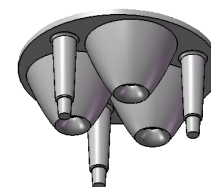

WARNING : If you Decide to use Glue only, Please Take Special Care of Correct Positioning