

TURLENS

Optics & Reflector



Datasheet



LED 1w Power

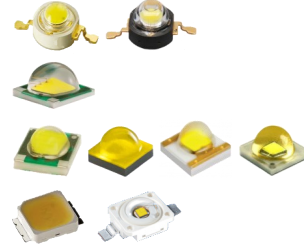

Code : 18 3570 D

35 & 70 ° Degree

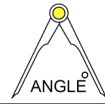

LIGHTING PARAMETERS

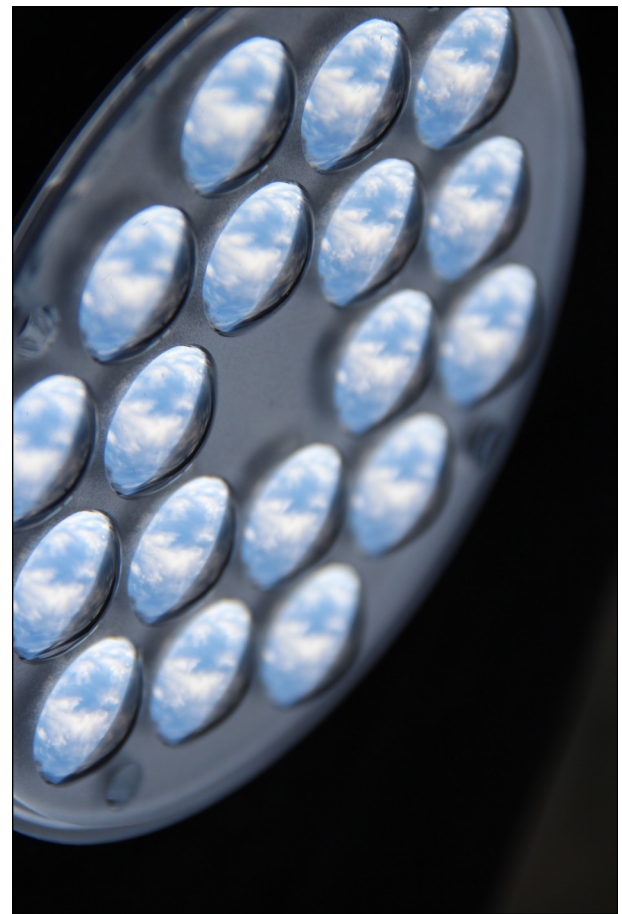
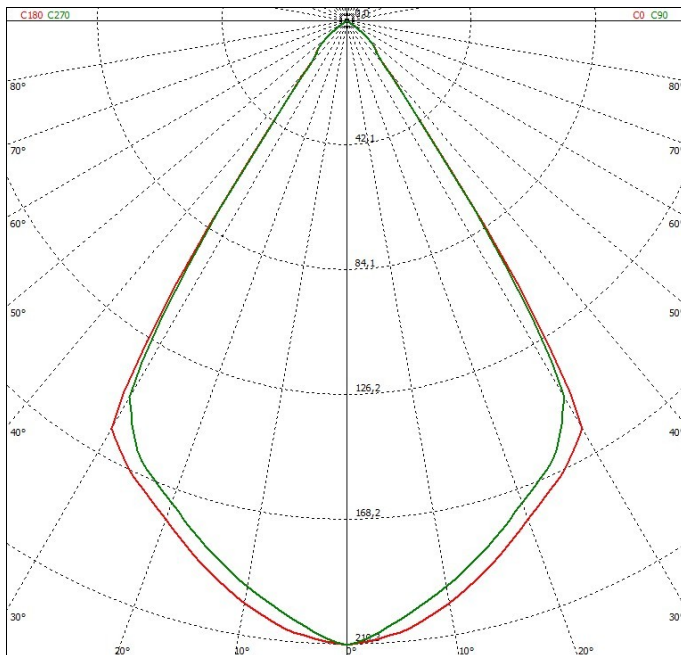
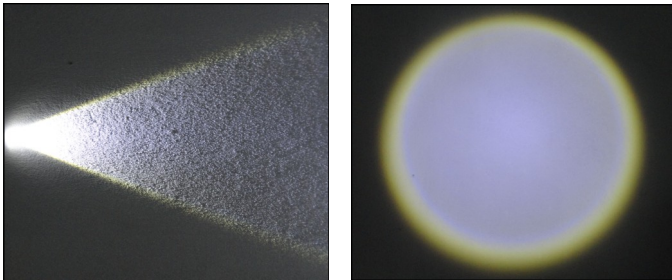

Box Quantity : 56PCS
Box Size : 24*24*15 cm
Box Total Kg +/-3%: 3,25 Kg

PACKAGING

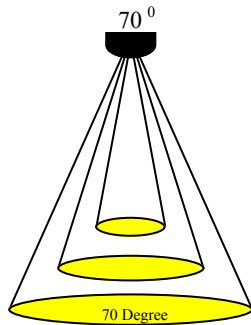

70 Degree
Light Dimension Parameters
1m / \varnothing : 1,40 m
2m / \varnothing : 2,80 m
3m / \varnothing : 4,23 m

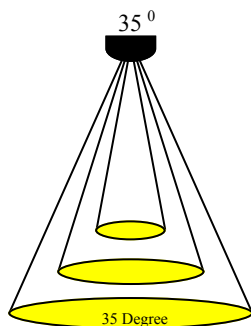

35 Degree
Light Dimension Parameters
1m / \varnothing : 0,64 m
2m / \varnothing : 1,28 m
3m / \varnothing : 1,92 m

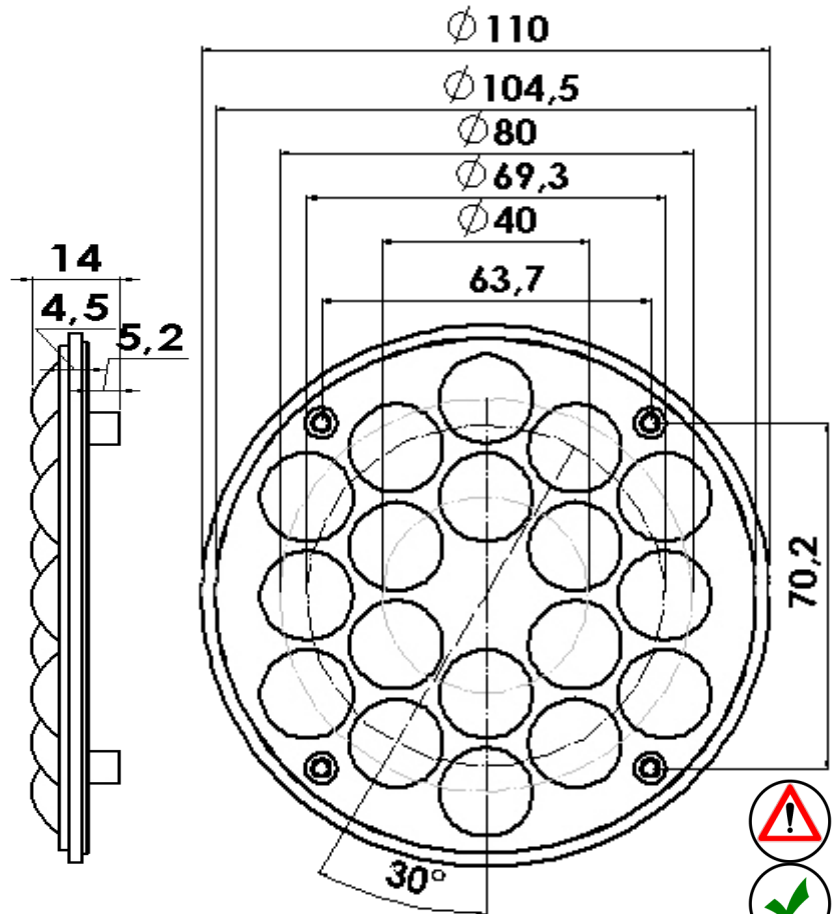

*TURLENS Custom Optical Design & Manufacture (Lens for LED's)All technical data contained in this document are properties of "TURLENS". Turlens may to change the content without prior notice.****

* Lens Use

* Streets, Offices, Homes, Stages, Architectural, Down Light , & Decorative Lighting

* Lens Material

- * Optical Grade PMMA / PC Best Available Optical Efficiency :
> 90 % ,PMMA with UV Light Transmittance High Productivity with 2mm Thickness
- * Operating Temperature: -40°C ~ + 80°C (upper limit +90°C) PMMA
- * Operating Temperature: -40°C ~ + 90°C (upper limit +100°C) PC
- * Average transmittance in visible spectrum: 400nm~700nm> 90% - (3mm thick PMMA)

* Holder information

* Operating Temperature: -40°C ~ + 110°C PC V2 & ROHS UV Resistant
Flammability Standard : V2 (burning stops within 30 seconds on a vertical specimen;
drips of flaming particles are allowed). High heat resistance

*Assembly Information

- * If adhesive is used, make sure that the adhesive is acid-free.
- * If you need to clean the lenses, use only mild soap and water. Use a very soft piece of cloth to dry.
- * Do not use any solvents on lenses
- * Our product is guaranteed against manufacturing defects only.
- * Do not store the product in a dusty & corrosive environment
- * Do not touch the optical portion of the lens with bare hands

