



ANGLE	CODE
50°	12SB50D

LED Type



BOX QUANTITI	108 P C S
BOX SIZE	36 * 33 * 18 cm
BOX WEIGHT	

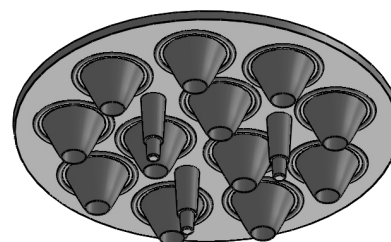
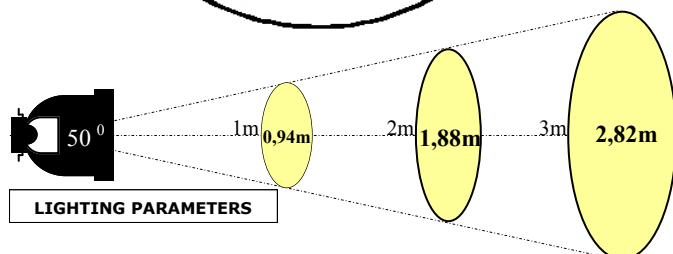
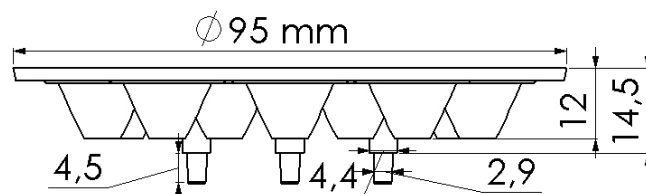
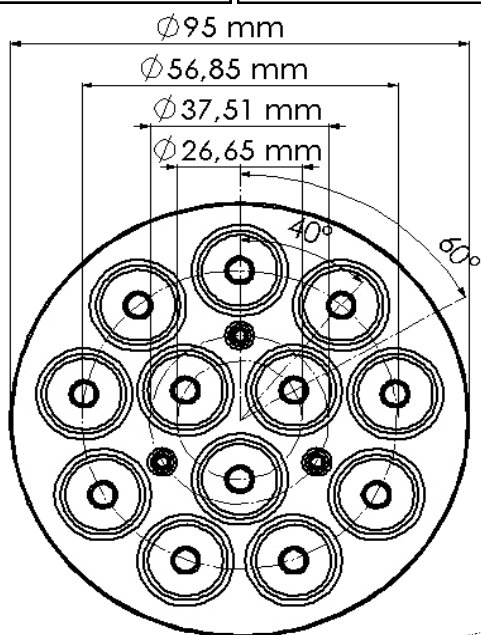
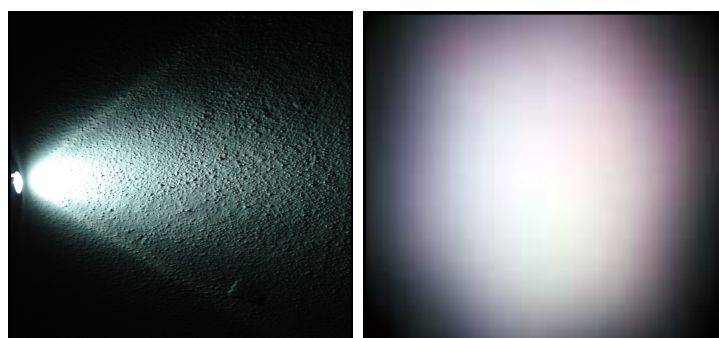

TURLENS USE : Street Lighting , Office Lighting , Home Lighting , Stage Lighting , Architectural Lighting , Down Light Lighting , Decorative Lighting

Lens INFO

Lens Material : Optical Grade Best Available Optical Efficiency

Lens Material : with high UV & Temperature Resistance -40°C ~ + 100°C

Lens Material : Light Transmittance High Productivity with 2mm Thickness

WARNING : If you Decide to use Glue only, Please Take Special Care of Correct Positioning