

**TURLENS**

Optics & Reflector



Datasheet



**LED** 1w Power



Code :10 D H 1 W

10<sup>0</sup> Degree

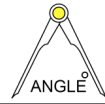

LIGHTING PARAMETERS

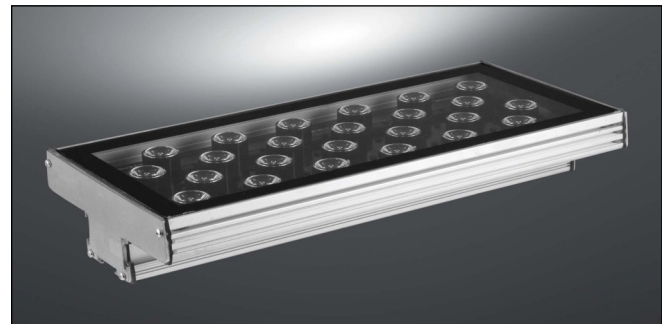
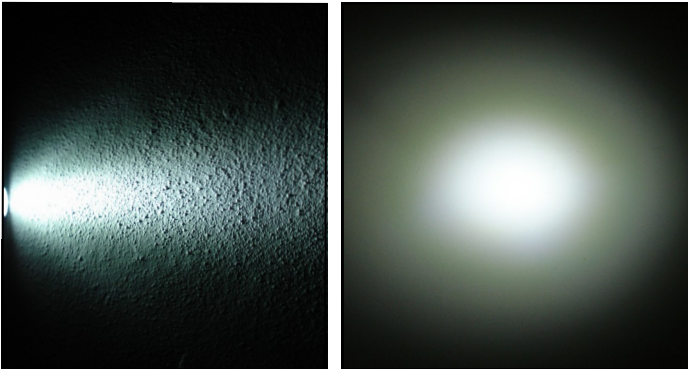

Box Quantity : 100X8=800 PCS  
Box Size : 24\*24\*15 cm  
Box Total Kg -/+%3: 3,63 Kg

PACKAGING

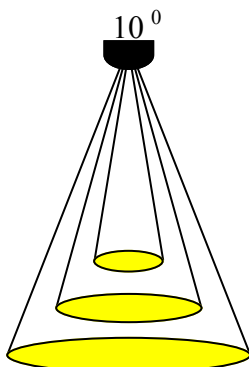
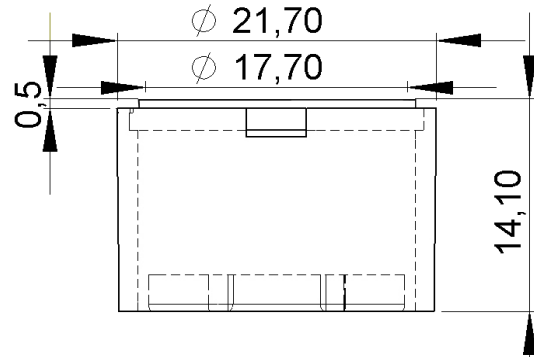
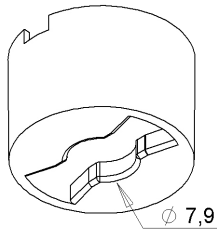

10 Degree  
Light Dimension Parameters  
1m /  $\phi$  : 0,17 m  
2m /  $\phi$  : 0,35 m  
3m /  $\phi$  : 0,55 m

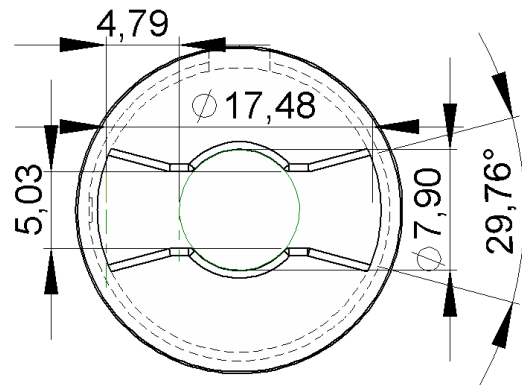

\*TURLENS Custom Optical Design & Manufacture ( Lens for LED's )All technical data contained in this document are properties of "TURLENS". Turlens may to change the content without prior notice.\*\*\*\*

\* Lens Use

\* Streets, Offices, Homes, Stages, Architectural, Down Light , & Decorative Lighting

\* Lens Material

- \* Optical Grade PMMA / PC Best Available Optical Efficiency : > 90 % ,PMMA with UV Light Transmittance High Productivity with 2mm Thickness
- \* Operating Temperature: -40°C ~ + 80°C (upper limit +90°C) PMMA
- \* Operating Temperature: -40°C ~ + 90°C (upper limit +100°C) PC
- \* Average transmittance in visible spectrum: 400nm~700nm> 90% - (3mm thick PMMA)

\* Holder information

\* Operating Temperature: -40°C ~ + 110°C PC V2 & ROHS UV Resistant  
Flammability Standard : V2 (burning stops within 30 seconds on a vertical specimen;  
drips of flaming particles are allowed). High heat resistance

\*Assembly Information

- \* If adhesive is used, make sure that the adhesive is acid-free.
- \* If you need to clean the lenses, use only mild soap and water. Use a very soft piece of cloth to dry.
- \* Do not use any solvents on lenses
- \* Our product is guaranteed against manufacturing defects only.
- \* Do not store the product in a dusty & corrosive environment
- \* Do not touch the optical portion of the lens with bare hands

